

MASTER : TRADING



Components for modern pig production

MASTER TRADING

MASTER TRADING specializes in components for modern pig production.

MASTER TRADING's product program is trendsetting within modern pig production, and the company's great values are:

- Usability in the stable
- Animal welfare
- Design
- Optimal logistics
- Competitive prices

MASTER TRADING's office is located in Herning, Denmark. Here, you can visit our *SHOWROOM* and see our wide range of products. Without any commitment you can see, feel and try out the differences and functions and thereby choose the solution that matches exactly your needs. You can, of course, also get professional guidance from our experienced sales consultants.



YOU ARE WELCOME TO CONTACT US



Jan Therkildsen
Sales Manager
M. +45 21 53 56 68
jt@mastertrading.dk



Claes Petersen
Key Account Manager
M. +45 29 60 65 49
cp@mastertrading.dk



Bjørn Dalsgaard
Sales back-up
T. +45 30 66 34 37
bd@mastertrading.dk



INDEX

3 Master Trading

3 Contact

6 Feeders

8 TUBE-O-MAT VI+ & CLASSIC
14 TUBE-O-MAT VI+ LTD & CLASSIC LTD
20 FUNKIMAT
24 Feed outlets and downpipes
27 Feed bowls
28 BABY FEEDER
30 BOX FEEDER
32 Feed dispensers
36 MASTER VALVE SOW
37 MASTER VALVE DRY

38 Drinkers

41 DRIK-O-MAT and NN DRINKERS
42 VIP-O-MAT and other drinkers for weaners and piglets
43 Tilttable troughs

44 Drinking valves

45 Pressure valves
46 Tilt valves
47 Bite valves

48 Farrowing pens

51 FUNKI Farrowing pen
52 INN-O-CRATE Farrowing pen
53 Sow troughs and accessories for farrowing pens
55 Types of farrowing pens
56 INN-O-CORNER piglets nest
57 Rubber mats for piglets nests
58 Heating lamps
62 Manipulating materials

64 Flooring

66 COMBI-FLOOR
67 Cast iron slats for COMBI-FLOOR
68 Plastic slats for COMBI-FLOOR



- 69 Supports and other accessories for COMBI-FLOOR
- 72 Heating plates & accessories
- 74 Self supporting cast iron slats

76 Board profiles

- 79 PVC board profiles
- 80 Fiber board profiles & accessories

82 Climate covers

- 84 FLEXCOVER
- 86 Accessories for FLEXCOVER

88 Troughs

- 90 Stainless steel troughs
- 94 Polymer concrete troughs and other polymer products
- 97 Feed tables for cattle
- 98 BIOFORM troughs

100 Dry feeding system

- 103 Corners, corner wheels and feed tubes
- 104 MASTER CHAIN, POWERLINE Chain and wires
- 105 Accessories for dry feeding systems

106 Fasteners

- 109 Fasteners for flooring
- 111 INN-O-PLUG
- 112 Clamps
- 113 Accessories for water pipes
- 114 Hinges and handles

116 Terms of sales and delivery

FEEDERS

Optimal feed solutions for weaners and finishers based on FUNKI's and Egebjerg's many years of experience with feed dispensers.

We offer feeders for all age groups - easy to mount and easy to use. The feeders are designed for easy filling, and to ensure optimal utilization of the volume.





TUBE-O-MAT®

VI+ & CLASSIC

The optimum feeder with maximum user-friendliness

VOLUME

Hopper	83 L /approx. 58 kg
Hopper Jumbo	160 L /approx. 112 kg

CAPACITY PER TROUGH

Weaners up to 30 kg:	30-50 pigs
Wean-to-Finish 7-120 kg:	30-50 pigs
Finishers 18-120 kg:	30-50 pigs
Jumbo:	50-70 pigs

TROUGH

1 mm stainless steel

FRAME

3 mm stainless steel

WATER SUPPLY

3/8" stainless steel pipe, external thread
Adjustable press nipple, stainless steel, item no. 93245

The optimum feeder

- Complete program for weaners, Wean-to-Finish and finishers
- Lid with three feed inlets ensures a correct filling
- The arched, dust-repellent shape of the lid ensures a maximum space utilization
- Transparent shielding and lid ensure better overview and easy hygiene control
- The opening part of the lid is placed in a low height in order to make manual filling and inspection easy
- Vertical sides to prevent bridging
- Water supply via flexible PE-hoses ensures a constant supply of water and easy mounting

TUBE-O-MAT VI+

- 89550* TUBE-O-MAT VI+, WEAN-TO-FINISH
- 89560* TUBE-O-MAT VI+, FINISHER



TUBE-O-MAT VI+ JUMBO

- 89650* TUBE-O-MAT VI+ JUMBO, WEAN-TO-FINISH
- 89660* TUBE-O-MAT VI+ JUMBO, FINISHER



* Can be delivered assembled (item no.+M) or unassembled (item no.+U).



TUBE-O-MAT CLASSIC

- 89585* TUBE-O-MAT CLASSIC, WEAN-TO-FINISH
- 89587* TUBE-O-MAT CLASSIC, FINISHER



TUBE-O-MAT CLASSIC JUMBO

- 89685* TUBE-O-MAT CLASSIC JUMBO, WEAN-TO-FINISH
- 89687* TUBE-O-MAT CLASSIC JUMBO, FINISHER

* Can be delivered assembled (item no.+M) or unassembled (item no.+U).

ACCESSORIES FOR TUBE-O-MAT VI+ & CLASSIC

- 38524 MOUNTING KIT FOR U-POST, AGAINST FEEDERS



ACCESSORIES FOR TUBE-O-MAT VI+

- 76262 FEED OUTLET SET, FOR TUBE-O-MAT VI+



- 72391 SPIRAL, FOR TUBE-O-MAT VI+



- 72235 ADJUSTMENT BAR, FOR TUBE-O-MAT VI+, LENGTH 680 MM



For reconstruction of TUBE-O-MAT VI+ use 76262 + 72235

ACCESSORIES FOR TUBE-O-MAT CLASSIC

- 76275 FEED OUTLET SET, FOR TUBE-O-MAT CLASSIC



ACCESSORIES FOR TUBE-O-MAT LTD VI+ & LTD CLASSIC

- 72395 SPIRAL, FOR TUBE-O-MAT CLASSIC



- 72209 ADJUSTMENT BAR, FOR TUBE-O-MAT LTD CLASSIC, LENGTH 775 MM



For reconstruction of TUBE-O-MAT CLASSIC use 76275 + 72209



TUBE-O-MAT VI+ (WITH WEAN-TO-FINISH TROUGH) - 89550

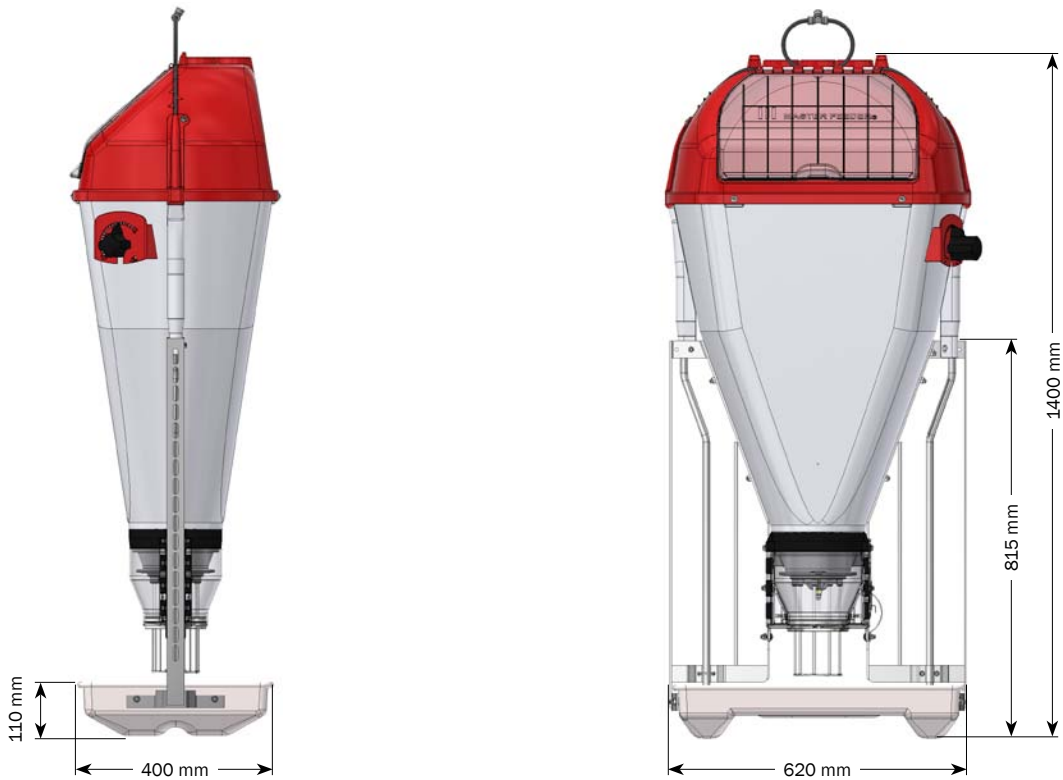

TUBE-O-MAT VI+ JUMBO (WITH FINISHER TROUGH) - 89660

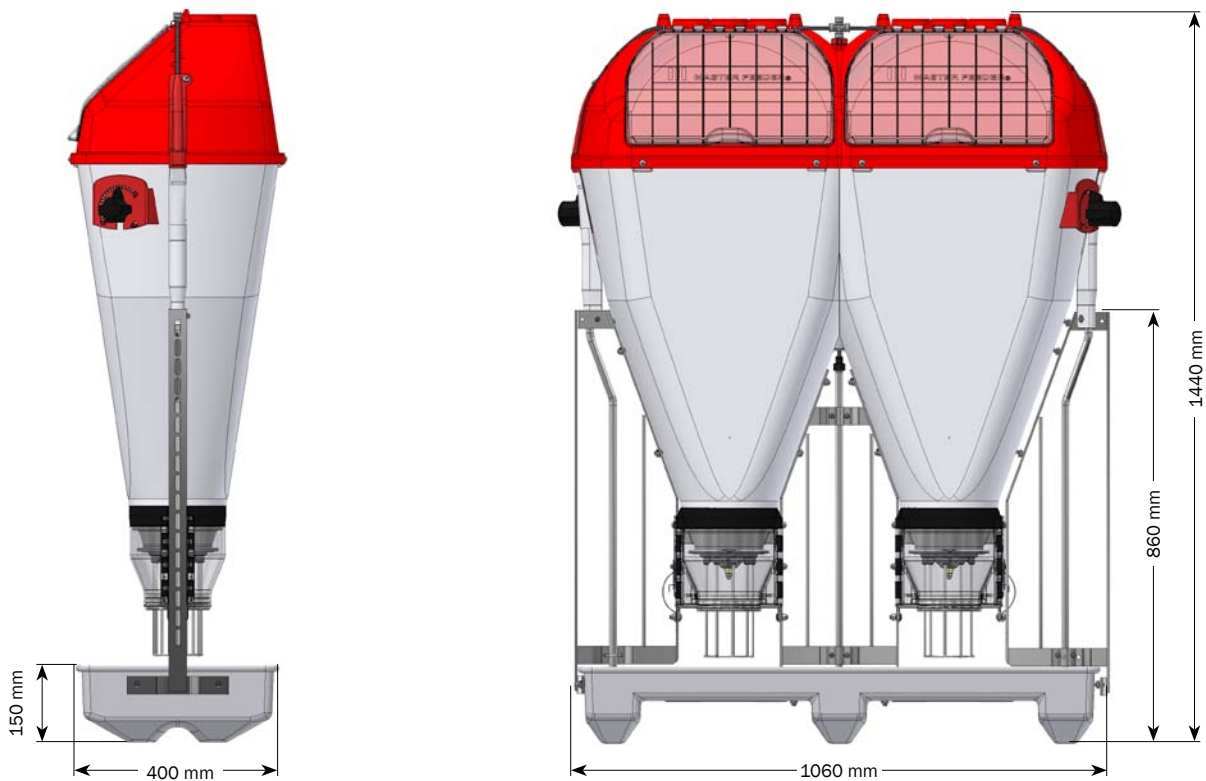

TUBE-O-MAT CLASSIC (WITH FINISHER TROUGH) - 89587

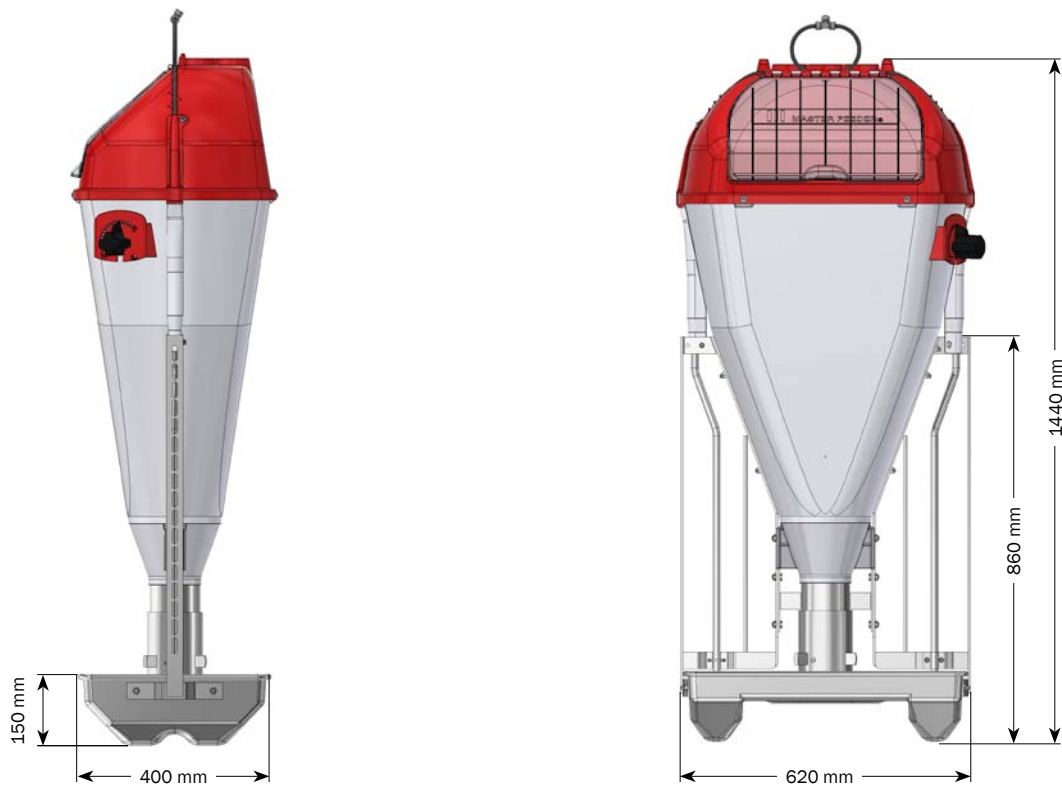

TUBE-O-MAT CLASSIC JUMBO (WITH WEAN-TO-FINISH TROUGH) - 89685

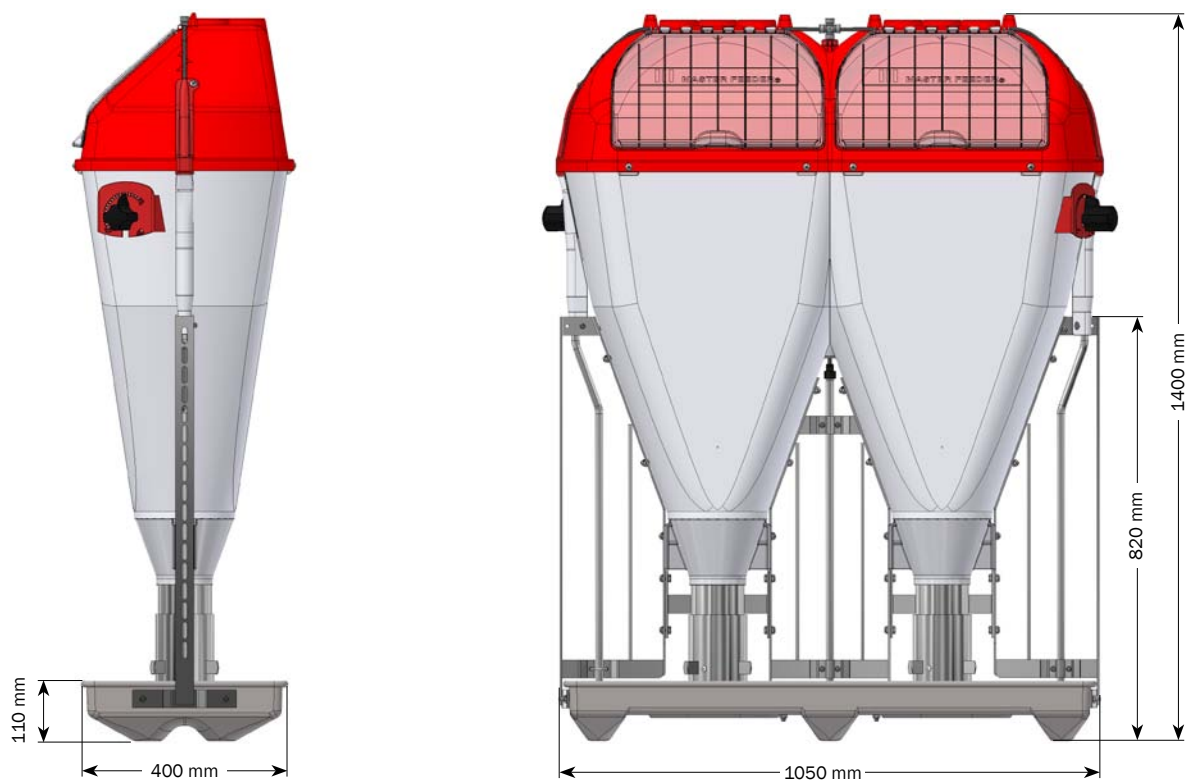



TUBE-O-MAT®

VI+ LTD & CLASSIC LTD

Complete program for weaners, Wean-to-Finish and finishers

VOLUME

Hopper	100 L / approx. 70 kg
Hopper Jumbo	190 L / approx. 130 kg

TROUGH

1 mm stainless steel

FRAME

3 mm stainless steel

CAPACITY PER TROUGH

Weaners up to 30 kg:	30-50 pigs
Wean-to-Finish 7-120 kg:	30-50 pigs
Finishers 18-120 kg:	30-50 pigs
Jumbo:	50-70 pigs

WATER SUPPLY

3/8" stainless steel pipe with external thread
Stainless steel press valve item no. 93245

The original feeder

- The design prevents bridging
- The hopper has a large filling hole and a low filling height
- The lid closes tight and the adjustable feed supply ensures fresh feed
- The design ensures top hygiene and easy cleaning

TUBE-O-MAT VI+ LTD

- 89551* TUBE-O-MAT VI+ LTD, WEAN-TO-FINISH
- 89561* TUBE-O-MAT VI+ LTD, FINISHER



TUBE-O-MAT VI+ LTD JUMBO

- 89651* TUBE-O-MAT VI+ LTD JUMBO, WEAN-TO-FINISH
- 89661* TUBE-O-MAT VI+ LTD JUMBO, FINISHER



* Can be delivered assembled (item no.+M) or unassembled (item no.+U).



TUBE-O-MAT CLASSIC LTD

- 89590* TUBE-O-MAT CLASSIC LTD, WEAN-TO-FINISH
- 89595* TUBE-O-MAT CLASSIC LTD, FINISHER



TUBE-O-MAT CLASSIC LTD JUMBO

- 89690* TUBE-O-MAT CLASSIC LTD JUMBO, WEAN-TO-FINISH
- 89695* TUBE-O-MAT CLASSIC LTD JUMBO, FINISHER

* Can be delivered assembled (item no.+M) or unassembled (item no.+U).

FLOOR PLATES FOR TUBE-O-MATS

- 89014 FLOOR PLATE PLASTIC, FOR SINGLE TUBE-O-MAT, 1000X800 MM
- 89016 FLOOR PLATE PLASTIC, FOR DOUBLE TUBE-O-MAT, 1200X800 MM

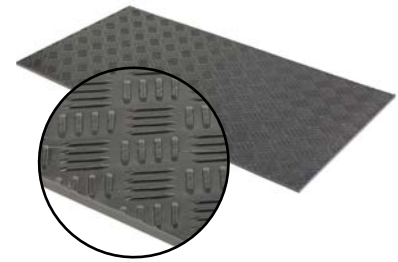

ACCESSORIES FOR TUBE-O-MATS

- 74501 FOOT BRACKET H: 16 CM, W: 18 CM, FINISHER
- 74502 FOOT BRACKET H: 12 CM, W: 18 CM, WEAN-TO-FINISH
- 74503 FOOT BRACKET H: 16 CM, W: 25 CM, FINISHER
- 74504 FOOT BRACKET H: 12 CM, W: 25 CM, WEAN-TO-FINISH



- 71008 TROUGH, FOR VI+, 11X40X60 CM, WEAN-TO-FINISH
- 71009 TROUGH, FOR VI+ AND TUBE, 15X40X60 CM, FINISHER
- 71029 TROUGH, FOR CLASSIC, 11X40X60 CM, WEAN-TO-FINISH
- 71030 TROUGH, FOR CLASSIC, 15X40X60 CM, FINISHER



- 71058 TROUGH VI+ JUMBO, 11X40X103,5 CM, WEAN-TO-FINISH
- 71059 TROUGH VI+ JUMBO AND TUBE, 15X40X103,5 CM, FINISHER
- 71069 TROUGH CLASSIC JUMBO, 11X40X103,5 CM, WEAN-TO-FINISH
- 71070 TROUGH CLASSIC JUMBO, 15X40X103,5 CM, FINISHER



TUBE-O-MAT VI+ LTD (WITH WEAN-TO-FINISH TROUGH) - 89551

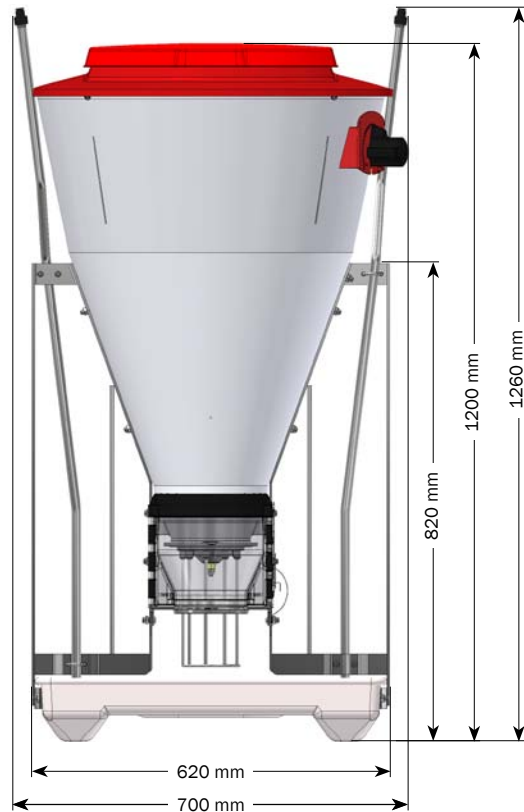

TUBE-O-MAT VI+ LTD JUMBO (WITH FINISHER TROUGH) - 89661

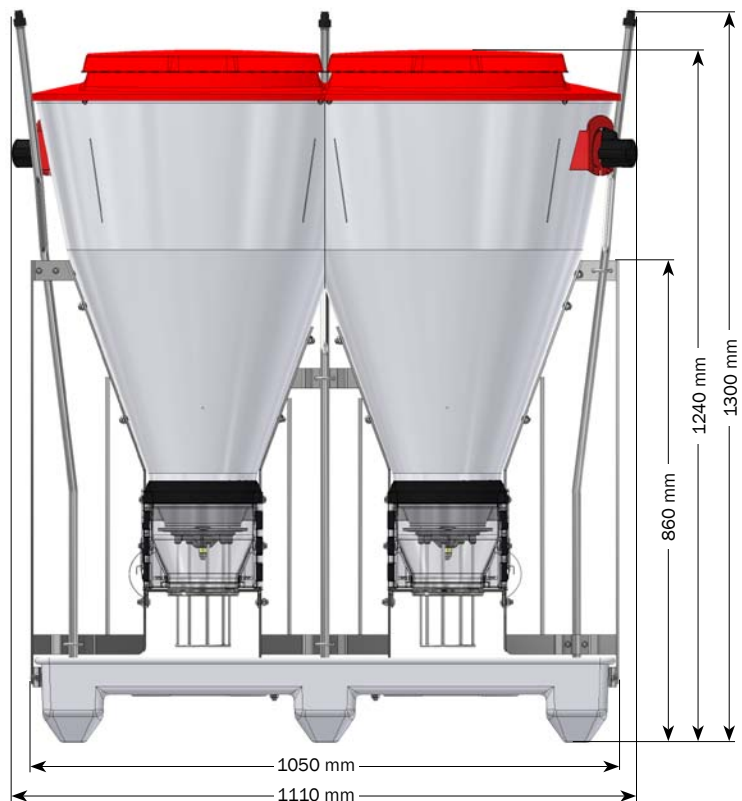

TUBE-O-MAT CLASSIC LTD (WITH FINISHER TROUGH) - 89595

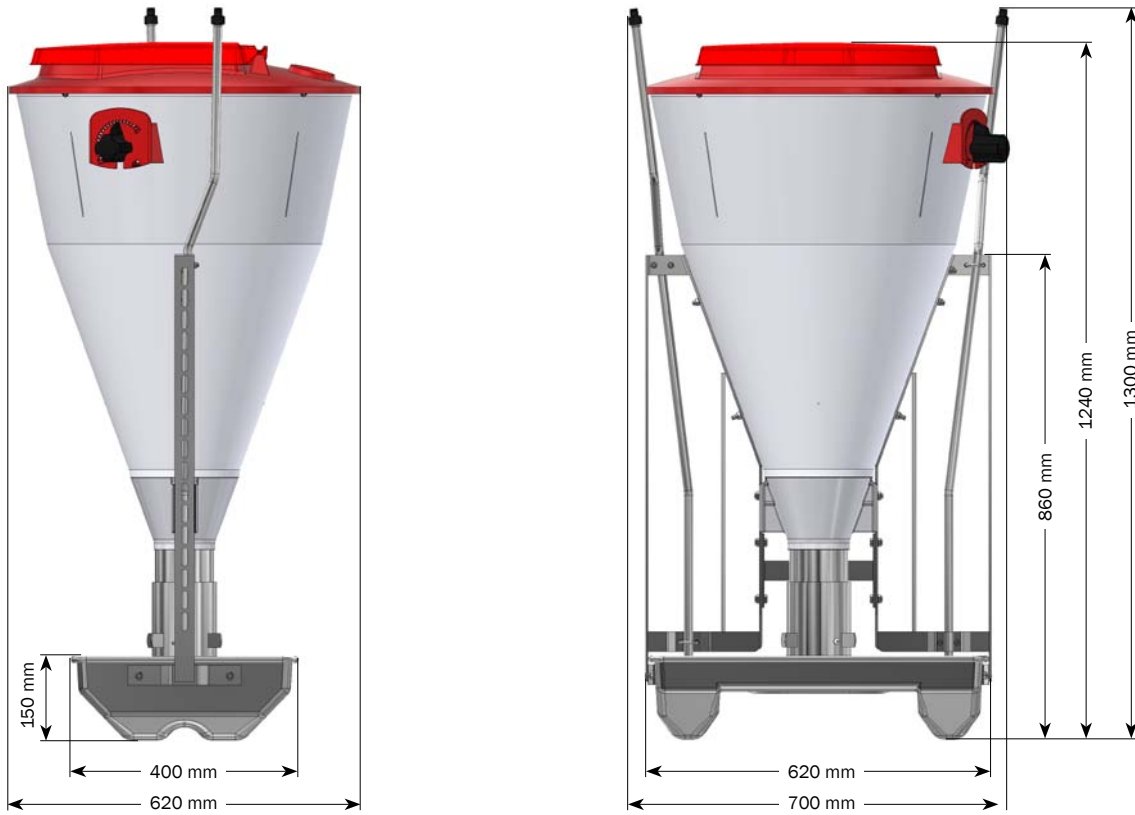

TUBE-O-MAT CLASSIC LTD JUMBO (WITH WEAN-TO-FINISH TROUGH) - 89690

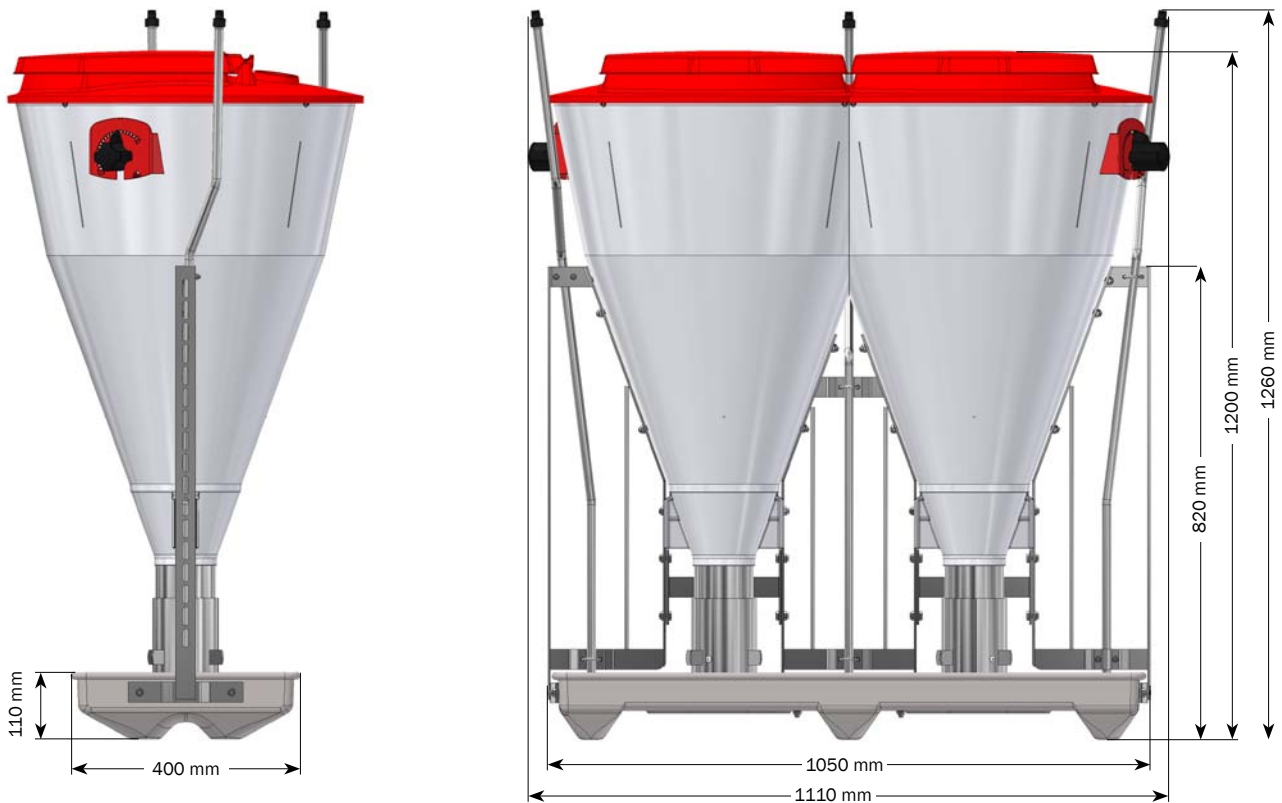

FUNKIMAT® FEEDERS

Easy adjustable feeder for weaners and finishers, 6 - 120 kg

VOLUME

FUNKIMAT	100 L
3IN1 ROTO	100 L
DOUBLE	200 L

TROUGH

1 mm stainless steel

FRAME

3 mm stainless steel

CAPACITY PER FEEDER

FUNKIMAT	50 pigs (6-120 kg)
3IN1 ROTO	50 pigs (6-120 kg)
DOUBLE	80 weaners / 70 finishers

- Available for weaners and finishers
- Optimum well-being for pigs
- High daily weight gain
- Can be used for both meal and pellets
- Water and feed separated
- No bridging
- Large adjustment handle allows easy and fast regulation of feeding
- Exact feed dosage ensures continuously fresh feed

FUNKIMAT SINGLE - WITH POLYMER TROUGH

- 560560* FUNKIMAT, FOR WEANER, WITH POLYMER TROUGH (FLAT-FLAT)
- 560561* FUNKIMAT, FOR FINISHER, WITH POLYMER TROUGH (FLAT-FLAT)



FUNKIMAT SINGLE - WITH STAINLESS STEEL TROUGH

- 560710* FUNKIMAT, FOR WEANER, WITH STAINLESS STEEL TROUGH (FLAT-FLAT)
- 560711* FUNKIMAT, FOR FINISHER, WITH STAINLESS STEEL TROUGH (FLAT-FLAT)



FUNKIMAT DOUBLE

- 0227-870 DOUBLE FUNKIMAT, FOR WEANER, (FLAT-FLAT) - ASSEMBLED
- 0227-970 DOUBLE FUNKIMAT, FOR FINISHER, (FLAT-FLAT) - ASSEMBLED
- 0227-670 DOUBLE FUNKIMAT, (FLAT-FLAT) - UNASSEMBLED
- 0227-714 STAINLESS STEEL TROUGH, FOR DOUBLE FUNKIMAT, WEANER, COMPLETE
- 0227-715 STAINLESS STEEL TROUGH, FOR DOUBLE FUNKIMAT, FINISHER, COMPLETE

0227-870 consists of 0227-670 + 0227-714

0227-970 consists of 0227-670 + 0227-715



* Can be delivered assembled (item no.+M) or unassembled (item no.+U).

ACCESSORIES FOR FUNKIMATS



- 0227-088 DOSAGE DISC VER. 3, Ø174 MM
- 0227-309 DOSAGE DISC VER. 4, Ø164 MM



- 0227-370 RETAINER SPRING FOR DOSAGE DEVICE, STAINLESS STEEL VER. 2



- 38524 MOUNTING KIT FOR U-POST AGAINST FEEDERS



- 0227-150 TROUGH FOOT FOR FEEDER, ADJUSTABLE, STAINLESS STEEL



- 0227-700 PRESSED TROUGH, FOR SINGLE FUNKIMAT, WEANER, STAINLESS STEEL
- 0227-701 PRESSED TROUGH, FOR SINGLE FUNKIMAT, FINISHER, STAINLESS STEEL



- 0227-704 PRESSED TROUGH, FOR DOUBLE FUNKIMAT, WEANER, STAINLESS STEEL
- 0227-705 PRESSED TROUGH, FOR DOUBLE FUNKIMAT, FINISHER, STAINLESS STEEL

FUNKIMAT SINGLE (FOR WEANERS) - 560710

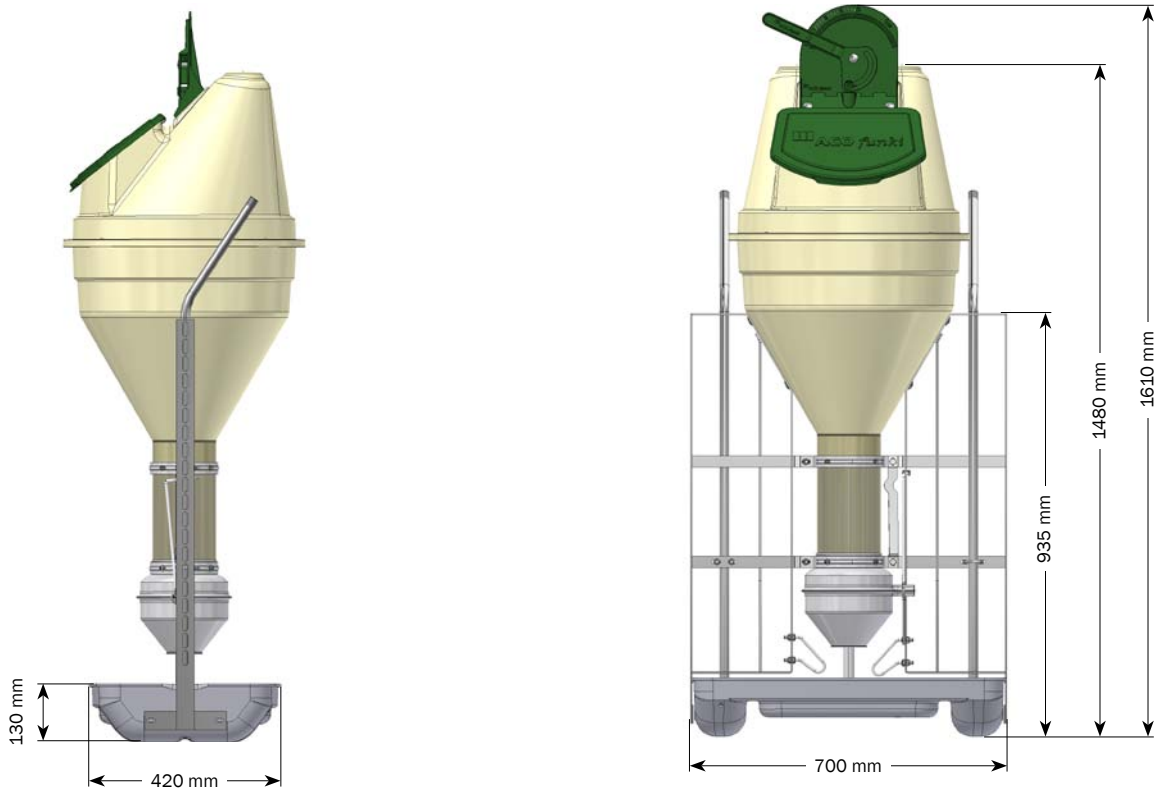

FUNKIMAT DOUBLE (FOR FINISHERS) - 0227-970

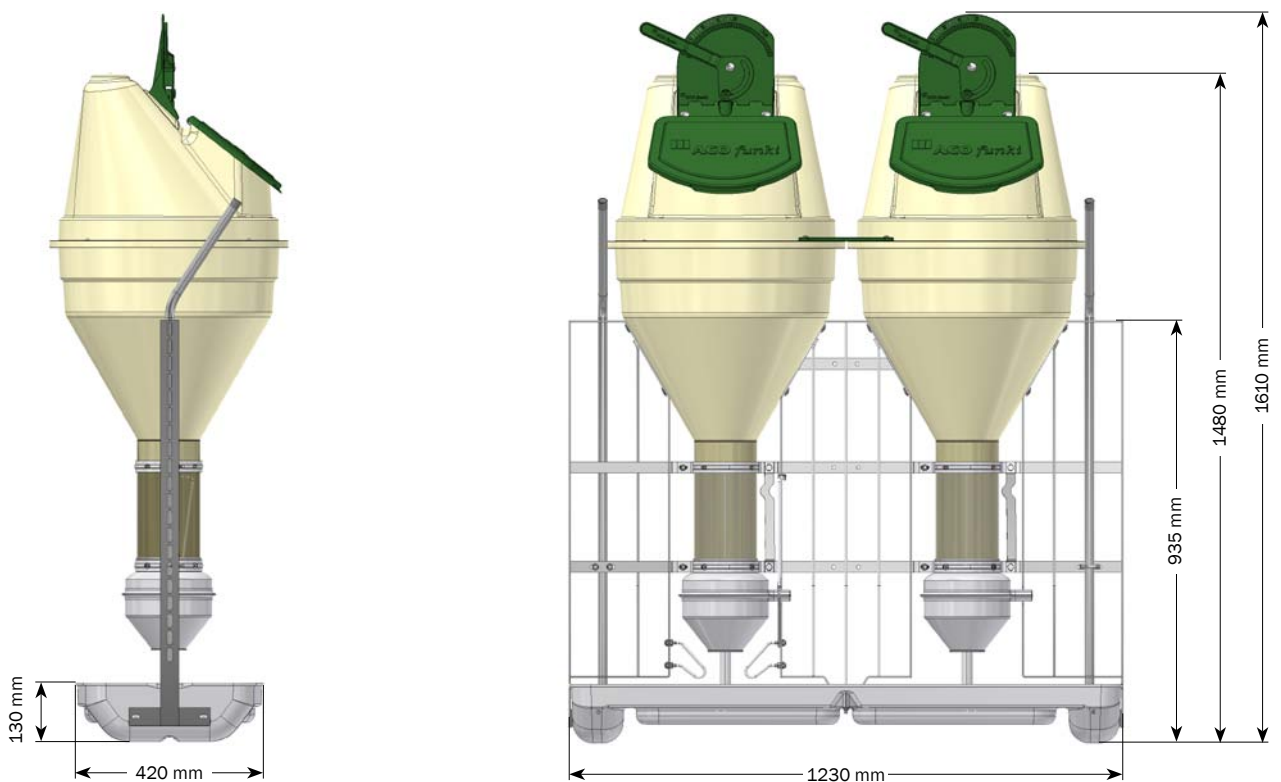

FEED OUTLETS & DOWNPIPES

Efficient and hygienic feed outlets for feeders

OUTLET SIZES

38 / 60 mm and
38 / 50 / 60 / 76 mm

- Feed outlet with a number of unique functional advantages
- Quick and efficient draining of feed
- Great hygiene
- Large capacity
- Always dry feed. Designed to keep out water and moisture
- Reliable slide that fits tightly to the feed pipe and prevents feed from accumulating

T-PIECES

- 90482 FIXED T-PIECE, FOR 38 MM
- 90484 FIXED T-PIECE, FOR 50 MM
- 90486 FIXED T-PIECE, FOR 60 MM
- 0228-488 FIXED T-PIECE, FOR 76 MM



Feeders



- 0142-015 T-PIECE WITH SLIDE, Ø38
- 0232-010 T-PIECE WITH SLIDE, Ø60



SLIDES

- 0232-007 SLIDE FOR T-PIECE (RED)
- 0232-009 SLIDE FOR T-PIECE (BLACK)



TELESCOPE PIPES

- 0228-595 TELESCOPE PIPE, Ø67,5 MM
- 0228-480 TELESCOPE PIPE, Ø80 MM



DOWNPIPES

- 0228-588 DOWNPIPE, Ø63X2X1000 MM, WITH HOLE
- 90249 DOWNPIPE, Ø75X1000 MM





■ 90210 Y-BRANCH, Ø75 MM, 90°



■ 90211 Y-BRANCH, Ø63 MM, 60°



■ 90212 Y-BRANCH, Ø63 MM, 30°



■ 0228-500 Y-BRANCH, Ø75-63-63 MM, WITH LOCK, 60°



■ 0228-510 Y-BRANCH, Ø75 MM, 60°



■ 90208 BEND, Ø75 MM MALE/NIPPLE, 45°

FEED BOWLS

FEED BOWLS - PLASTIC

- 96061 PAN FOR PIGLETS, Ø26 CM
- 96063 PAN FOR PIGLETS, Ø39 CM



FEED BOWL - STEEL

- 560395 BOWL WITH FIXING HOOK, Ø24 CM, 2,5 L, STAINLESS STEEL



FEED BOWLS - POLYMER CONCRETE

- 03186 BOWL FT19, Ø19 CM



- 06906 BOWL FTK 27, WITH CONE AND INNER RIM, Ø27 CM



- 554154 BOWL 326-T, Ø26 CM





BABY FEEDER®

Unique mix of feed and water. For pigs from 4 kg

WATER

Connection Provided with 3 m hose of 8 mm
Pressure 2,5 bar (recommended)

ENERGY

Energy plug SCHUKO plug as standard
Cable 4,5 m
Connection No electrician needed

FEED

Feed types Pellets and meal feed

TROUGH

1 mm stainless steel

FRAME

3 mm stainless steel

- The best start for pigs after weaning
- Increases feed and water intake
- Ensures optimal growth
- Fills the trough when the sensor indicates it is empty
- Always fresh feed and water
- Easy to clean
- Reliable and easy to operate
- Adjustable pause time from emptying to feed assignment
- Possible to adjust water volume
- Up to 60 pigs per feeder

BABY FEEDER

BABY FEEDER

■ 0229-000 BABY FEEDER



BABY FEEDER (WITH WEAN-TO-FINISH TROUGH) - 0229-000

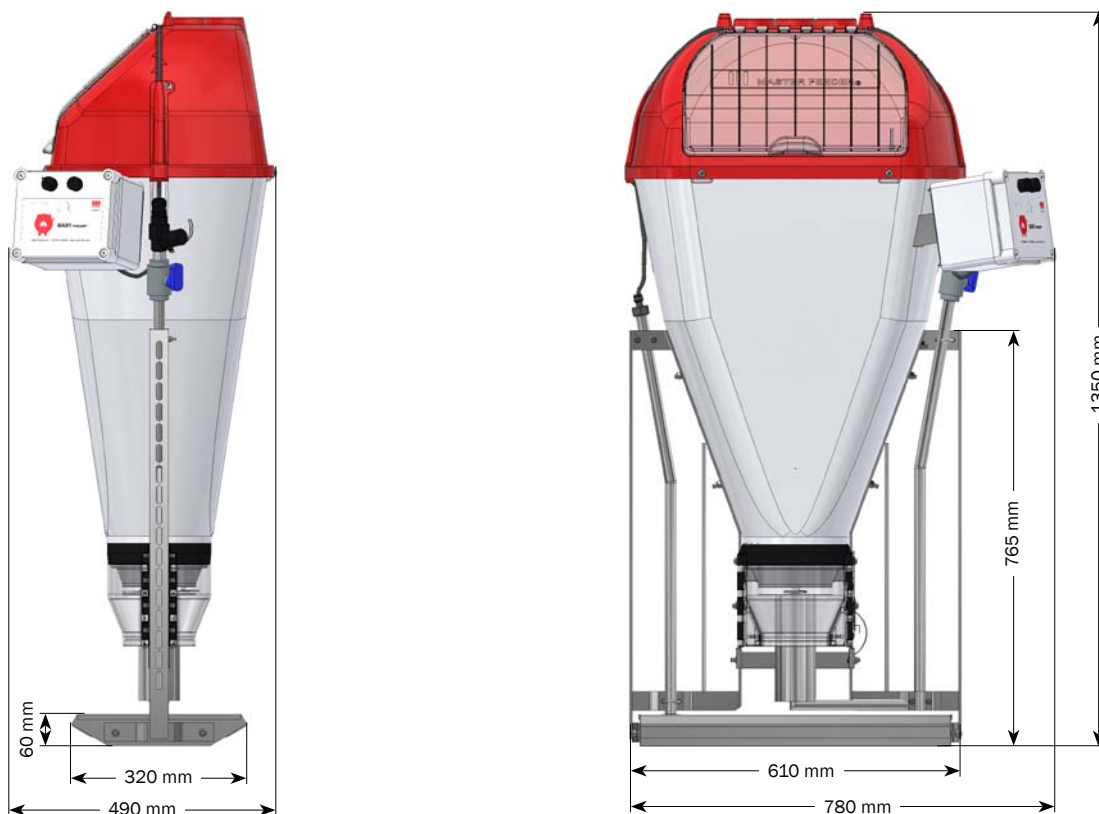



BOX FEEDER

With INOX trough and front

MATERIALS

PE and stainless steel

TYPES

For weaners and finishers

SIZES

Feed for 20-120 pigs per feeder

- Easy access to feed
- No sharp edges
- Easy to clean
- Minimum feed waste
- Main frame made of strong PE material
- Accurate multi-staged regulation
- Highly resistant
- Excellent value for money

BOX FEEDERS FOR WEANERS - SINGLE (STAINLESS STEEL)

- 560042* BOX FEEDER, WEANERS, 2X1, 41,5X74X31 CM, 20 PIGS
- 560043* BOX FEEDER, WEANERS, 3X1, 41,5X74X31 CM, 30 PIGS
- 560044* BOX FEEDER, WEANERS, 4X1, 81,5X74X31 CM, 40 PIGS
- 560045* BOX FEEDER, WEANERS, 5X1, 101,5X74X31 CM, 50 PIGS
- 560046* BOX FEEDER, WEANERS, 6X1, 121,5X74X31 CM, 60 PIGS



BOX FEEDERS FOR WEANERS - DOUBLE (STAINLESS STEEL)

- 560052* BOX FEEDER, WEANERS, 2X2, 41,5X74X62 CM, 40 PIGS
- 560053* BOX FEEDER, WEANERS, 3X2, 61,5X74X62 CM, 60 PIGS
- 560054* BOX FEEDER, WEANERS, 4X2, 81,5X74X62 CM, 80 PIGS
- 560055* BOX FEEDER, WEANERS, 5X2, 101,5X74X62 CM, 100 PIGS
- 560056* BOX FEEDER, WEANERS, 6X2, 121,5X74X62 CM, 120 PIGS



BOX FEEDERS FOR FINISHERS - SINGLE (STAINLESS STEEL)

- 560062* BOX FEEDER FINISHER, 2X1, 61,5X99X39 CM, 20 PIGS
- 560063* BOX FEEDER FINISHER, 3X1, 91,5X99X39 CM, 30 PIGS
- 560064* BOX FEEDER FINISHER, 3X1, 91,5X99X39 CM, 40 PIGS
- 560065* BOX FEEDER FINISHER, 5X1, 151,5X99X39 CM, 50 PIGS



BOX FEEDERS FOR FINISHERS - DOUBLE (STAINLESS STEEL)

- 560072* BOX FEEDER FINISHER, 2X2, 61,5X99X80 CM, 40 PIGS
- 560073* BOX FEEDER FINISHER, 3X2, 91,5X99X80 CM, 60 PIGS
- 560074* BOX FEEDER FINISHER, 4X2, 120,5X99X80 CM, 80 PIGS
- 560075* BOX FEEDER FINISHER, 5X2, 151,5X99X80 CM, 100 PIGS



* Can be delivered assembled (item no.+M) or unassembled (item no.+U).

FEED DISPENSERS

Reliable feed distribution and accurate dosage

VOLUME

6 L / 8 L / 10 L

FITS FEED TUBES

VD2 Ø38 / Ø50 / Ø60 / Ø70 MM
 VD5 Ø38 / Ø50 / Ø60 / Ø70 MM / Ø76 MM
 VD6 Ø38 / Ø50 / Ø60 / Ø70 MM
 VD22 Ø38 / Ø50 / Ø60 / Ø70 MM

DISPENSER TYPES

Ball / Flap

- **Reliable feed distribution even by small amounts**
 Strong bottom, the feed does not sift out inadvertently. At the same time, the dispenser is emptied at every feeding - no feed remains in the hopper
- **Accurate dosage**
 No feed dosing pipe in the feed dispenser. The scale shows the exact amount being distributed
- **Easy adjustment**
 The amount of feed is easily adjusted by using the handle on the side of the feed dispenser. The handle can be operated from the feed corridor
- **Extra durable**
 Minimum wear because of the simple construction

VD100 FEED DISPENSER

- 0223-240* VD100 FLOOR FEEDER



VD2 FEED DISPENSERS

- 0221-252 VD2 - Ø60, 6 L, WITH FLAP, Ø75 MM OUTLET
- 0221-253 VD2 - Ø60, 8 L, WITH FLAP, Ø75 MM OUTLET
- 0221-254 VD2 - Ø60, 10 L, WITH FLAP, Ø75 MM OUTLET



- 0221-138 BOTTOM, WITH CLOSING FLAP AND ARM, FOR VD1+VD2



- 0221-127 SLIDE, WITHOUT HOLE



VD6 FEED DISPENSERS

- 0222-660 VD6 - Ø60, 6 L, WITH FLAP, Ø75 MM OUTLET
- 0222-668 VD6 - Ø60, 8 L, WITH FLAP, Ø75 MM OUTLET



ACCESSORIES FOR VD2 AND VD6

- 0131-191 CONNECTION FOR VD2 Ø60 / Ø38
- 0221-400 CONNECTION FOR VD2 Ø60 / Ø50
- 0221-401 CONNECTION FOR VD2 Ø60 / Ø55



* Can be delivered assembled (item no.+M) or unassembled (item no.+U).



VD5 FEED DISPENSERS, DECENTRALIZED

- 0221-953 VD5 - Ø38 MM, 8 L, WITH BALL, Ø75 MM OUTLET
- 0221-952 VD5 - Ø50 MM, 8 L, WITH BALL, Ø75 MM OUTLET
- 0221-954 VD5 - Ø55 MM, 8 L, WITH BALL, Ø75 MM OUTLET
- 0221-951 VD5 - Ø60 MM, 8 L, WITH BALL, Ø75 MM OUTLET
- 0221-950 VD5 - Ø75 MM, 8 L, WITH BALL, Ø75 MM OUTLET



VD5 FEED DISPENSERS, CENTRALIZED

- 0221-963 VD5 - Ø38 MM, 8 L, WITH Ø75 MM OUTLET
- 0221-962 VD5 - Ø50 MM, 8 L, WITH Ø75 MM OUTLET
- 0221-964 VD5 - Ø55 MM, 8 L, WITH Ø75 MM OUTLET
- 0221-961 VD5 - Ø60 MM, 8 L, WITH Ø75 MM OUTLET
- 0221-960 VD5 - Ø75 MM, 8 L, WITH Ø75 MM OUTLET



ACCESSORIES FOR VD5

- 0221-980 BOTTOM FOR VOLUME DISPENSER VD5, DECENTRALIZED OUTLET



- 0221-939 BOTTOM FOR VOLUME DISPENSER VD5, CENTRALIZED OUTLET



VD22 FEED DISPENSERS

- 0221-506 VD22 - Ø60, 6 L, WITHOUT OUTLET
- 0221-508 VD22 - Ø60, 8 L, WITHOUT OUTLET
- 0221-510 VD22 - Ø60, 10 L, WITHOUT OUTLET



ACCESSORIES FOR VD22

- 0221-512 VD2 BOTTOM HOPPER, FOR Ø75 MM OUTLET
- 0221-515 VD5 BOTTOM HOPPER, FOR DECENTRALIZED Ø75 MM OUTLET
- 0221-516 VD5 BOTTOM HOPPER, FOR Ø75 MM OUTLET





MASTER VALVE SOW

Feed dispenser with integrated pneumatic valve - perfect for phase feeding of sows

VOLUME

6 L

PIPE SIZE

Ø38 - 60 mm valve / Ø75 mm outlet

- Perfect for phase feeding of sows in the farrowing and gestation units
- Saves feed costs
- Optimal use of feeding system
- User-friendly control unit
- Simple and reliable
- Lock for feed release, if the sow has not eaten up
- Easy to adjust the feed amount
- Can be adjusted while the feed dispenser is full

MASTER VALVE SOW

- 0222-655 MASTER VALVE SOW - COMPLETE

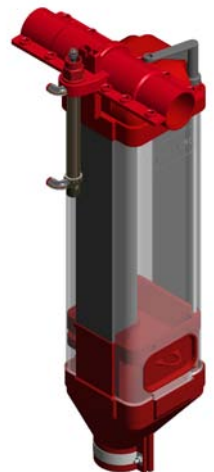



MASTER VALVE DRY

Pneumatic valve for dry feed with Y-outlet

- Special Y-outlet for simultaneous use with several dry feeding units
- Operates with a pneumatic cylinder with air pressure
- Individually controlled feeding
- Easy lock
- Easy cleaning of pipes

PIPE SIZE

Ø60 mm valve / Ø75 mm outlet



MASTER VALVE DRY

- 0228-550 DRY FEED VALVE - COMPLETE



DRINKERS

Master Trading provides you with the best of the best of drinkers. Our range consists of top-hygienic drinkers for weaners, sows and finishers - as well as drinkers specially developed for piglets. It all started with the mother of all drinking cups - The DRIK-O-MAT.





DRINKERS

Hygienic drinkers for all types of pigs

DRIK-O-MAT and NN DRINKING CUPS

- Rounded, hygienic design
- For all pig types
- Stainless steel

VIP-O-MAT - for piglets

- Top hygiene and tiltable bottom plate
- Connects to sow water or separate water supply
- Stainless steel and plastic

STAINLESS STEEL DRINKING CUP - for piglets

- Top hygiene
- Connects to sow water
- Height adjustable drinking valve

PIGLET DRINKER

- Top hygiene and tiltable bottom plate
- Connects to sow water or separate water supply
- Stainless steel and plastic

DRIK-O-MAT®

- 93570 DRIK-O-MAT MINI
- 93575 DRIK-O-MAT STANDARD
- 93600 DRIK-O-MAT MULTI
- 93500 DRIK-O-MAT MAXI



MINI



STANDARD



MULTI



MAXI



NN DRINKING CUPS

- 560120 MINI DRINKING CUP, ASSEMBLED
- 560130 STANDARD DRINKING CUP, ASSEMBLED
- 560140 MULTI DRINKING CUP, ASSEMBLED
- 560160 MAXI DRINKING CUP, ASSEMBLED



MINI



STANDARD



MULTI



MAXI

NIPPLE PIPES FOR DRIK-O-MAT® AND NN DRINKING CUPS

- 94039 NIPPLE PIPE, 1/2", 830 MM, WITH THREAD, STAINLESS STEEL
- 06902111 NIPPLE PIPE, 1/2", 990 MM, WITH THREAD, STAINLESS STEEL
- 06902112 NIPPLE PIPE, 1/2", 1190 MM, WITH THREAD, STAINLESS STEEL
- 06902113 NIPPLE PIPE, 1/2", 1700 MM, WITH THREAD, STAINLESS STEEL

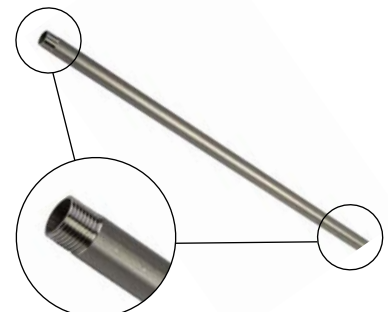

Thread in both ends

DRINKERS



VIP-O-MAT®

- 93520 VIP-O-MAT, INCL. HOSE PROTECTOR



STAINLESS STEEL DRINKING CUP

- 2100622 PIGLET DRINKER, PIPE LENGTH 130 MM, STAINLESS STEEL
- 2100625 PIGLET DRINKER, PIPE LENGTH 352 MM, STAINLESS STEEL



PIGLET DRINKER

- 43730 PIGLET DRINKER



MASTER FLOW

- 93469 MASTER FLOW, INCL. 1/2' PLUG

MOUNTING HEIGHT - DRINKERS

Description	For	Pigs per cup	Mounting height
Mini DRIK-O-MAT	Weaners	30	12 cm
Standard DRIK-O-MAT	Finishers	30	25 cm
Multi DRIK-O-MAT	Wean-To-Finish and sows	30 weaners	12 cm
		20 finishers	12 cm
		10 sows	35 cm
Maxi DRIK-O-MAT	Sows	10	35 cm



NIPPLE PIPES FOR MASTER FLOW

- 06902114 NIPPLE PIPE 1/2', 1195 MM, WITH THREAD, STAINLESS STEEL
- 06902115 NIPPLE PIPE 1/2', 1495 MM, WITH THREAD, STAINLESS STEEL

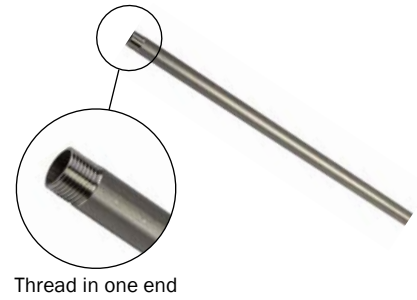

AQUA DROP

- 550490 AQUADROP II, 1/2', WITH STOP VALVE



NIPPLE PIPE FOR AQUA DROP

- 550491 PIPE FOR AQUADROP II, 1/2' X 120 CM

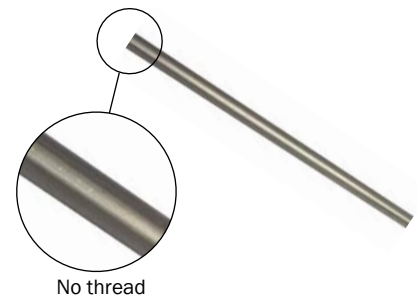

TILTABLE TROUGHS

- 1205901 TILT TROUGH FOR PIGLETS, WITH SUPPORT, PVC
- 1205902 TILT TROUGH FOR SOWS, WITH SUPPORT
- 1205903 TILT TROUGH FOR PIGLETS, WITH SUPPORT, STAINLESS STEEL



SOW TROUGH - STAINLESS STEEL

- 2950666 SOW TROUGH, DEEP DRAWN, STAINLESS STEEL
- 96054 BRACKET SET, FOR SOW TROUGH, INCL. BOLT FOR WALL
- 96056 BRACKET SET, FOR SOW TROUGH, INCL. BOLT FOR BOARD PROFILE
- 96058 BRACKET SET, FOR SOW TROUGH, SINGLE, MOUNTING ON GRILLE





DRINKING VALVES

A great selection of valves to fit all of our drinkers and feeders

TYPES

Pressure valves
Tilt valves
Bite valves

WATER PRESSURE

Recommended: 2,5 Bar

- Threads to fit pipes of several sizes
- Capacities to meet the requirements for water volumes
- Most of our drinking valve types are adjustable in water amount

PRESSURE VALVES

- 281490 PRESS NIPPLE 3IN1, 1/2' EXTERNAL THREAD, STAINLESS STEEL



- 12100342 PRESS NIPPLE TYPE 11, 1/2' INTERNAL THREAD, STAINLESS STEEL



- 93305 PRESS NIPPLE 1/2' INTERNAL THREAD, STAINLESS STEEL



- 12309005 WATER VALVE TYPE 5, 1/4' EXTERNAL THREAD, STAINLESS STEEL



DRINKING VALVES



TILT VALVES

- 93250 PRESS NIPPLE DRIK-O-MAT, 1/2' EXTERNAL THREAD, STAINLESS STEEL



- 560153 VALVE FOR DRINKING BOWL, 1/2' EXTERNAL THREAD, STAINLESS STEEL



- 281496 PRESS NIPPLE FOR TUBE-O-MAT FEEDER, 1/2' EXTERNAL THREAD, STAINLESS STEEL



- 93245 PRESS NIPPLE TUBE-O-MAT, 3/8' INTERNAL THREAD, STAINLESS STEEL



- 9900047 PRESS NIPPLE TYPE 17, 1/2' INTERNAL THREAD, STAINLESS STEEL



- 93280 PRESS NIPPLE SOWS 1/2' EXTERNAL THREAD, STAINLESS STEEL



- 12100107 DRINKING VALVE TYPE 13, 1/2', STAINLESS STEEL
- 12100108 DRINKING VALVE FOR PIGLET DRINKER, STAINLESS STEEL

DRINKING VALVES

BITE VALVES

- 9900053 BITE NIPPLE, 1/2' EXTERNAL THREAD, FOR WEANERS, STAINLESS STEEL
- 9900054 BITE NIPPLE, 1/2' EXTERNAL THREAD, FOR FINISHERS, STAINLESS STEEL



- 93345 BITE NIPPLE FOR PIGLETS, 3/8' EXTERNAL THREAD, STAINLESS STEEL
- 93343 BITE NIPPLE FOR SOWS, MALE THREAD 1/2', STAINLESS STEEL



- 9900058 BITE NIPPLE FOR SOWS, MALE EXTERNAL THREAD 1/2', BRASS



Drinkers



PRESSURE VALVES

Article no.	Description	Adjustable	L/min (at 2,5 bar)	Thread
281490	Pressure valve 3in1	yes	4	1/2' int.
12100342	Pressure valve 3in1, type 11	yes	4	1/2' int.
93305	Pressure valve	yes	4,5	1/2' int.
12309005	Pressure valve 1/4', type 5	no	-	1/4' ext.

TILT VALVES

Article no.	Description	Adjustable	L/min (at 2,5 bar)	Thread
93250	Tilt valve for DRIK-O-MAT	yes	4	1/2' ext.
560153	304 valve for drinking cup	yes	7	1/2' ext.
281496	Tilt valve for TUBE-O-MAT pipe	yes	4	1/2' ext.
93245	Tilt valve for TUBE-O-MAT	no	4	3/8' int.
9900047	Tilt valve, type 17	no	7	1/2' int.
93280	Tilt valve sows 13	no	4	1/2' ext.
12100107	Drinking valve 1/2', type 13	yes	5	1/2' int.
12100108	Drinking valve for piglet drinker	no	-	1/2' int.

BITE VALVES

Article no.	Description	Adjustable	L/min (at 2,5 bar)	Thread
9900053	Bite valve, weaners	yes	2,5	1/2' ext.
9900054	Bite valve, finishers	yes	4	1/2' ext.
93345	Bite valve, piglets	yes	1,5	3/8' ext.
9900058	Bite valve sows, brass	yes	6,5	1/2' ext.
93343	Bite valve sows	no	3	1/2' ext.

FARROWING PENS

50 years of experience with producing farrowing pens. ACO FUNKI and Egebjerg bring you to the top with high quality equipment.

You can find traditional farrowing pens, extra large crates and multi-adjustable crates.

Furthermore, the piglets can be sheltered by a covered piglets nest with insulating rubber mats and heating lamps.



Farrowing pens



Farrowing pens

FARROWING PENS

Traditional farrowing pen with multi-adjustable farrowing crate

FACTS

Pen length	260/270 cm
Pen width	160/170/180 cm
Pen height	50 cm
U-profiles	1,5 mm stainless steel
Board profiles	35 x 500 mm
Lying length	200-210 cm
Width farrowing crate, front	52-61 cm
Width farrowing crate, rear gate	57-85 cm
Height crate side	90 cm
Farrowing crate trough rail	40 x 40 x 4 mm / 50 x 50 x 4 mm
Crate side	33,7/42,4 x 2,65 pipe
Volume trough	21 liters
Piglets nest width	80/90 cm
Piglets nest area	0,7/0,8 m ²

Maximum production

- More weaned piglets and higher weight at weaning
- Ergonomic design of the crate ensures a safe movement behaviour
- The piglets have free access to the udder
- Maximum feed and water intake
- Large hygienic trough and crate design, that makes it easy for the sow to get up

FARROWING RAIL

- 2100850 FARROWING RAIL F208, WITHOUT FRONT PART



FARROWING PARTITIONS

- 2100563 FARROWING PARTITION F207, WITH TILT FENDER



- 2100144 FARROWING PARTITION F200S, WITH TILT FENDER

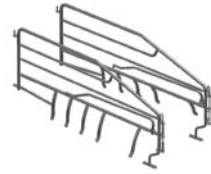

- 2100612 FARROWING PARTITION F200S, WITH TOP BAR

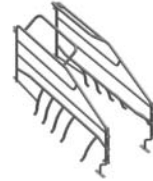

REAR GATES

- 2115051 REAR GATE F200, 45-65 CM, GALVANIZED



- 2120509 REAR GATE, LEFT, SOFT 3/4', GALVANIZED
- 2120510 REAR GATE, RIGHT, SOFT 3/4', GALVANIZED



- 2116509 REAR GATE, LEFT, SOFT 3/4'
- 2116510 REAR GATE, RIGHT, SOFT 3/4'





FARROWING RAILS

- 2700040 FARROWING RAIL INN-O-CRATE, WITHOUT FRONT GATE



- 2700099 FARROWING RAIL, WITH FRONT GATE AND INWARDS TILTED TROUGH



- 2700100 FARROWING RAIL, WITH FRONT GATE AND OUTWARDS TILTED TROUGH

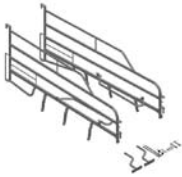

FARROWING PARTITIONS

- 2700320 FARROWING PARTITION XL STANDARD, WITH TILT FENDER
- 2700325 FARROWING PARTITION XL SHORT, WITH TILT FENDER



- 2700302 FARROWING PARTITION XL STANDARD, WITH TILT FENDER AND TOP BAR
- 2700300 FARROWING PARTITION XL SHORT, WITH TILT FENDER AND TOP BAR



REAR GATES

- 42335RD REAR GATE FOR FARROWING BOX XL, REVERSIBLE, RED



- 2720144 REAR GATE FOR FARROWING BOX XL, REVERSIBLE, GALVANIZED

TROUGH - PLASTIC

- 2100630 TROUGH KIT, FOR PLASTIC TROUGH



- 2900535 INTEGRATED DOWNPIPE, FOR PLASTIC TROUGH



TROUGHS - STAINLESS STEEL

- 2950666 SOW TROUGH, DEEP DRAWN, STAINLESS STEEL

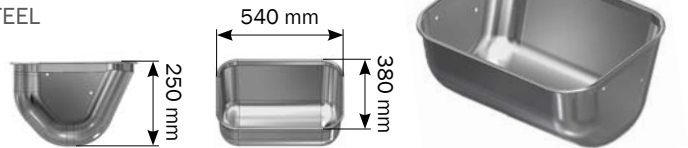

- 2100790 TROUGH KIT, FOR STAINLESS STEEL TROUGH



- 2900711 SOW TROUGH, WITH HOLE AND INTEGRATED DOWN PIPE, LEFT



- 2900712 SOW TROUGH, WITH HOLE AND INTEGRATED DOWN PIPE, RIGHT



ACCESSORIES FOR FARROWING PENS



WATER PIPE KITS

- 2100776 WATER PIPE KIT, FOR SOWS, WITH PVC WATER SUPPLY
- 2100652 WATER PIPE KIT, FOR SOWS, WITH STAINLESS STEEL WATER SUPPLY



DRY FEEDING SETS

- 0221-210 DRY FEEDING SET, FOR PVC WATER SUPPLY
- 0221-211 DRY FEEDING SET, FOR STAINLESS STEEL WATER SUPPLY

Farrowing pens

FUNKI FARROWING PENS

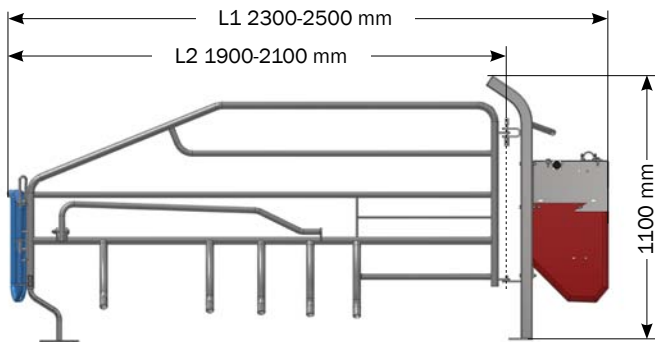

Farrowing partition F207 with tiltable wing (2100563)

- L1 (incl. rear gate): 2500 mm
- L2 (incl. rear gate): 2100 mm

Farrowing partition F200S with tiltable wing, short model (2100144)

- L1 (incl. rear gate): 2300 mm
- L2 (incl. rear gate): 1900 mm

Farrowing partition F200S without tiltable wing, with upper structure (2100612)

- L1 (incl. rear gate): 2300 mm
- L2 (incl. rear gate): 1900 mm

INN-O-CRATE FARROWING PENS

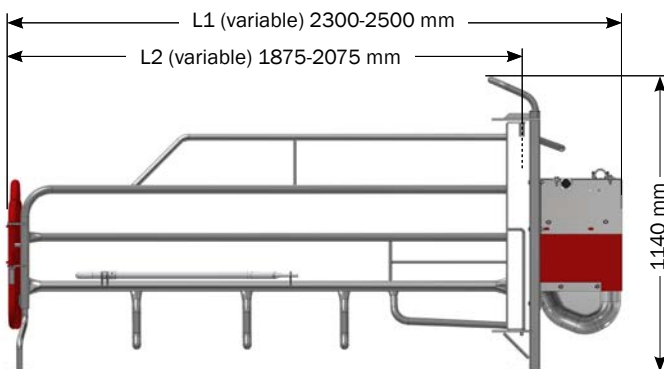

XL short, with tiltable wings (2700325)

and

XL short, with tiltable wings and upper structure (2700300)

- L1 (incl. rear gate): 2300 mm
 - L2 (incl. rear gate): 1875 mm
- } + 50 or 100 mm

XL standard, with tiltable wings (2700320)

and

XL standard, with tiltable wings and upper structure (2700302)

- L1 (incl. rear gate): 2400 mm
 - L2 (incl. rear gate): 1975 mm
- } + 50 or 100 mm

TYPES OF FARROWING PENS

We offer several solutions when it comes to the construction of farrowing pens. The farrowing pens can be constructed with different types of board profiles, each with its special characteristics and designed for different specific needs. Below, you can get an overview of our standard solutions, so you can choose the solution that best fits your stable.

Of course, our sales managers are always ready to guide you.

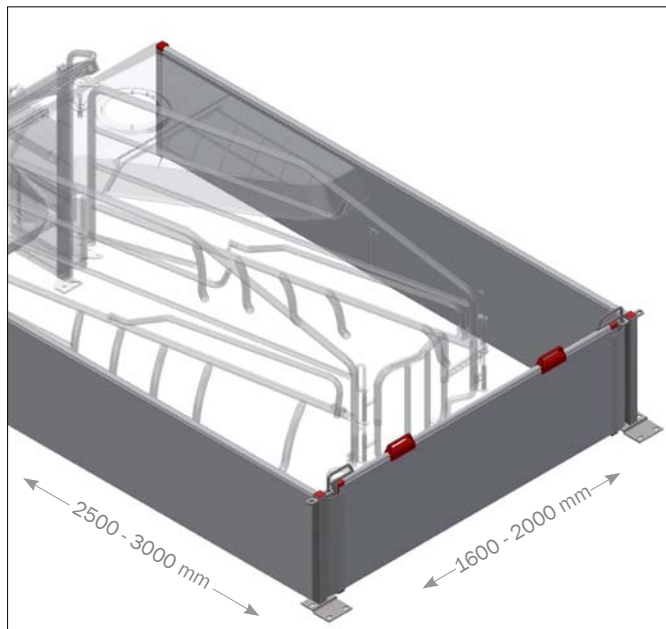

▲ GALVANIZED FARROWING PEN

The pen with strong, galvanized posts. Easy to open. Easy to clean. No sharp edges and corners where hoses can get caught during washing. Tiltable rear part operated with one hand.

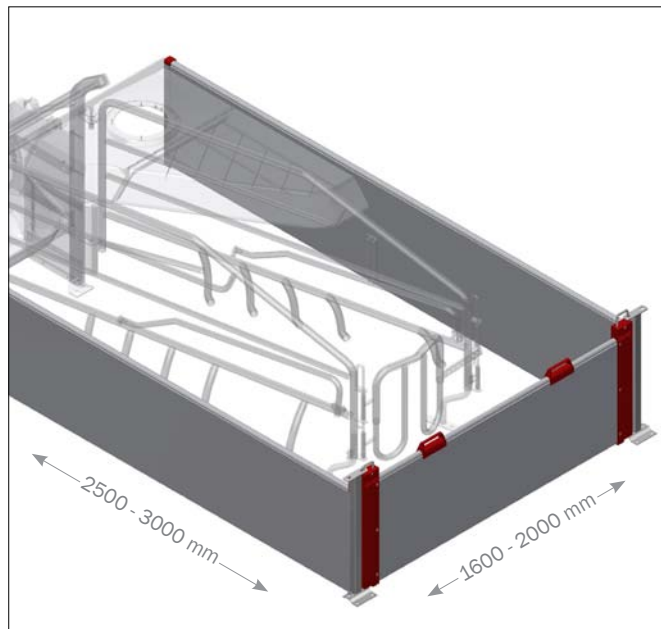

▲ STAINLESS FARROWING PEN

The pen with stainless steel bars and fittings. Easy to open. Easy to clean. Tiltable rear part operated with one hand.

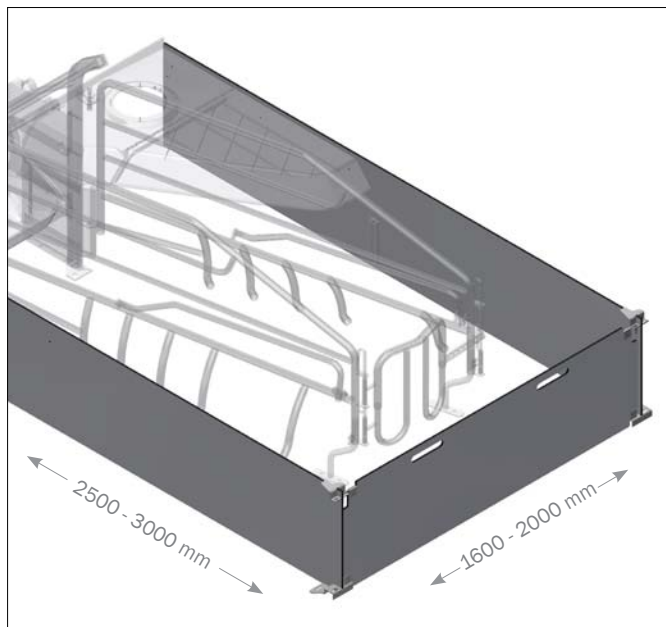

▲ FIBER FARROWING PEN

The pen built of solid panels with good resistance to diseases and bacterial infections. Fittings in steel. Easy to clean. No sharp edges and corners where hoses can get caught during washing. Considerably thinner board profiles, which gives more optimum space utilization as well as more pen space per m².

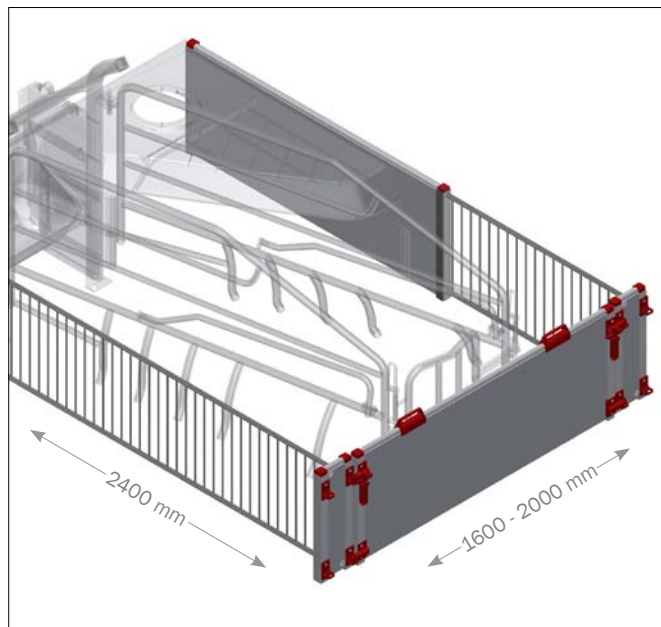

▲ OPEN FARROWING PEN

An open pen with grilles. The solution contributes to a good natural ventilation through the pen, and is specially developed for warm climates. Rear part with lock operated with one hand. Strong construction. No sharp edges and corners where hoses can get caught during washing.



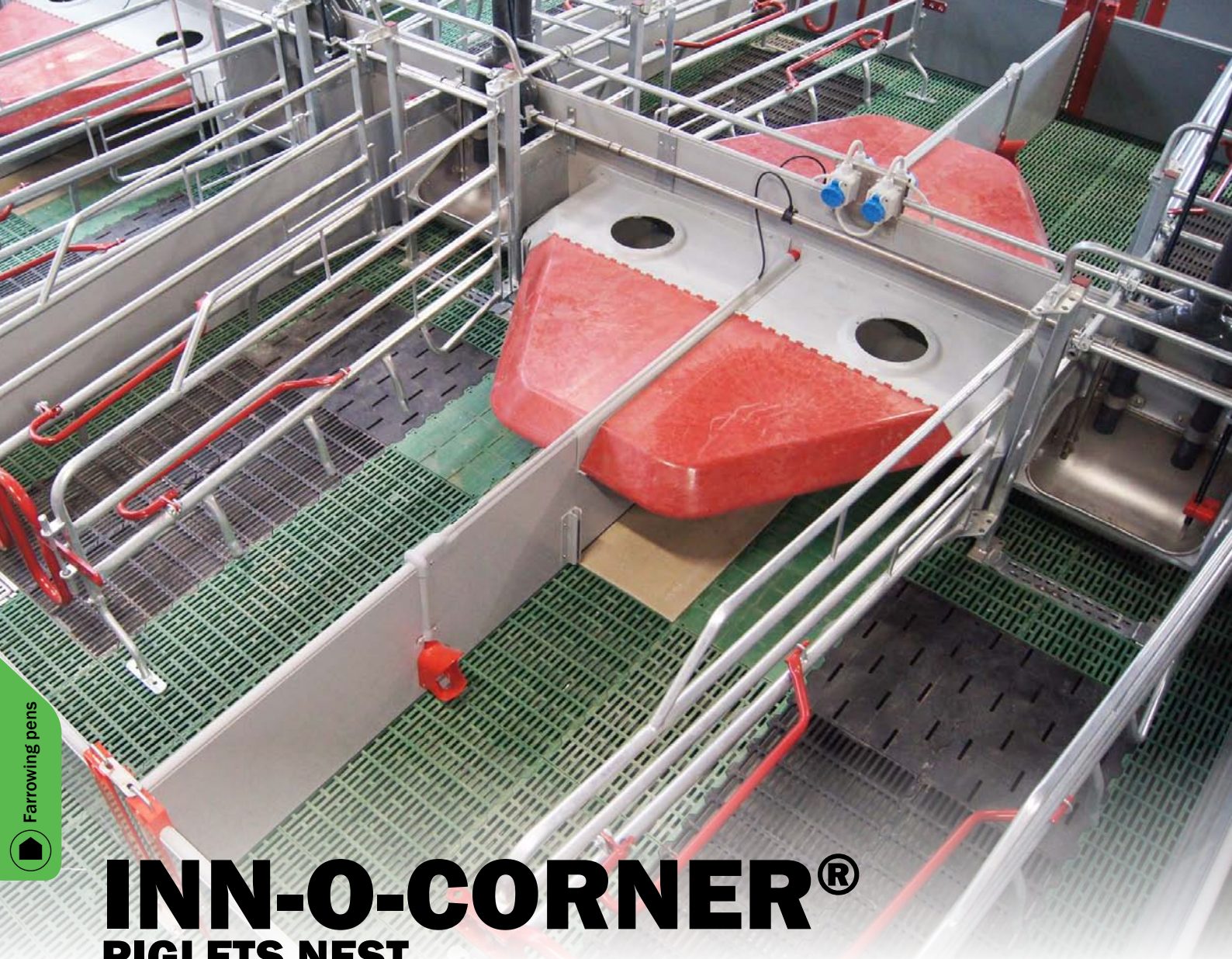

Farrowing pens

INN-O-CORNER®

PIGLETS NEST

Ensures the optimum climate for piglets

FACTS

Material: PP
Sizes: 80 cm (0,68 m²)
90 cm (0,80 m²)

- Optimum climate
- Closed side construction and tight joints between the cover area and the fixed part
- Up to 0,8 m² covered area
- Individual adjustment possible
- Easy access - light construction
- Slope on all cover parts; makes them easy to clean

Blocking plate for INN-O-CORNER®

- Matches INN-O-CORNER in design and function
- Easy inspection - free view of the piglets
- Lightweight - easy to handle

INN-O-CORNER

- 44080 INN-O-CORNER 80 CM, LEFT
- 44090 INN-O-CORNER 80 CM, RIGHT
- 44060 INN-O-CORNER 90 CM, LEFT
- 44070 INN-O-CORNER 90 CM, RIGHT

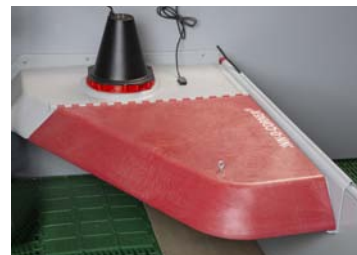

BLOCKING PLATES

- 8460380 BLOCKING PLATE FOR INN-O-CORNER, 1220X290 MM
- 44215 BLOCKING PLATE, 80 CM
- 44210 BLOCKING PLATE FOR INN-O-CORNER, 90 CM



- 44220 BLOCKING PLATE FOR PIGLETS, WITH HOLE

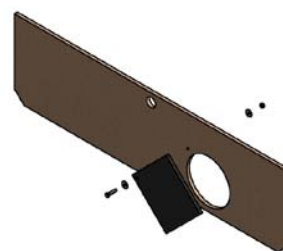

MOUNTING PROFILES

- 43516 INN-O-CORNER PROFILE, LEFT, AGAINST BOARD PROFILE
- 43511 INN-O-CORNER PROFILE, RIGHT, AGAINST BOARD PROFILE
- 43517 INN-O-CORNER PROFILE, LEFT, AGAINST WALL
- 43512 INN-O-CORNER PROFILE, RIGHT, AGAINST WALL
- 44008 INN-O-CORNER TOP PROFILE, DOUBLE



RUBBER MATS

- 27000011 INSULATING PIGLETS NEST MAT, 80 CM, LEFT
- 27000012 INSULATING PIGLETS NEST MAT, 80 CM, RIGHT
- 27000013 INSULATING PIGLETS NEST MAT, 90 CM, LEFT
- 27000014 INSULATING PIGLETS NEST MAT, 90 CM, RIGHT
- 44112 RUBBER MAT FOR PIGLETS NEST, 80 CM, REVERSIBLE
- 44118 RUBBER MAT FOR PIGLETS NEST, 90 CM, REVERSIBLE
- 27000024 RUBBER MAT FOR PIGLETS NEST, ONE ROLL, W=1,2 M, L=30 M



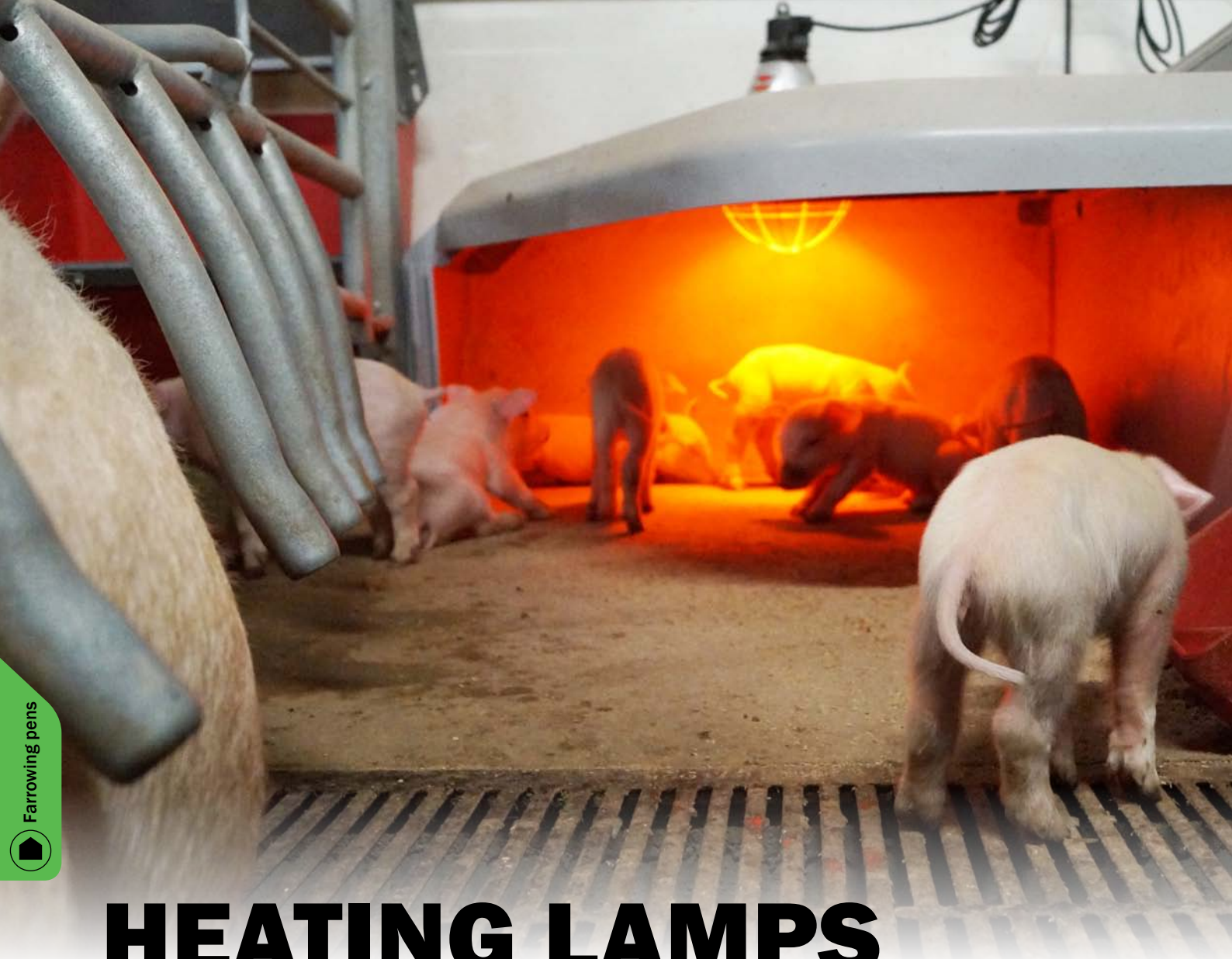

HEATING LAMPS

Master Lamp, FUNKI Lamp and Master Heater

MASTER LAMP and FUNKI LAMP

Effect Up to 250 W
Cable 250 cm

MASTER HEATER

Variants 100W / 150W / 150W, 10V
Cable 240 cm

Master Lamp & FUNKI Lamp

- Splash proof (IPX4)
- Bayonet socket - easy to mount on the cover of the piglets nest
- Available with regular plug (SCHUKO plug)

Master Heater

- Reduced energy consumption
- Even distribution of heat
- Waterproof IPX9K approved
- Long life expectancy
- Extra low fire risk
- No plug

HEATING LAMPS

MASTER LAMP

- 96341 MASTER LAMP, WITH REGULAR PLUG (SCHUKO PLUG)
- 96342 MASTER LAMP, CE PLUG, COMPLETE



FUNKI LAMP

- 9971000 HEATING LAMP, 21 CM, 2,5 M CABLE, REGULAR PLUG (SCHUKO PLUG)
- 9971004 HEATING LAMP, 21 CM, 2,5 M CABLE, CE PLUG



ACCESSORIES FOR MASTER LAMP AND FUNKI LAMP

- 2960510 LID FOR HEATING LAMP



- 2900588 ADAPTER FOR HEATING LAMP



HEATING LAMPS



MASTER HEATER

- 560500 MASTER HEATER 100W, WITHOUT PLUG
- 560550 MASTER HEATER 150W, WITHOUT PLUG
- 560510 MASTER HEATER 150W, 110V WITHOUT PLUG



- 560502 DOUBLE CONTROLLER, FOR 2 MASTER HEATERS
- 560516 MULTI CONTROLLER A16, FOR 18 MASTER HEATERS



- 8440156 DRILLING TEMPLATE FOR MASTER HEATER



PLUGS FOR HEATING LAMPS

- 560595 ADAPTER, CE FOR SCHUKO PLUG



- 560596 ADAPTER, SCHUKO FOR CE PLUG

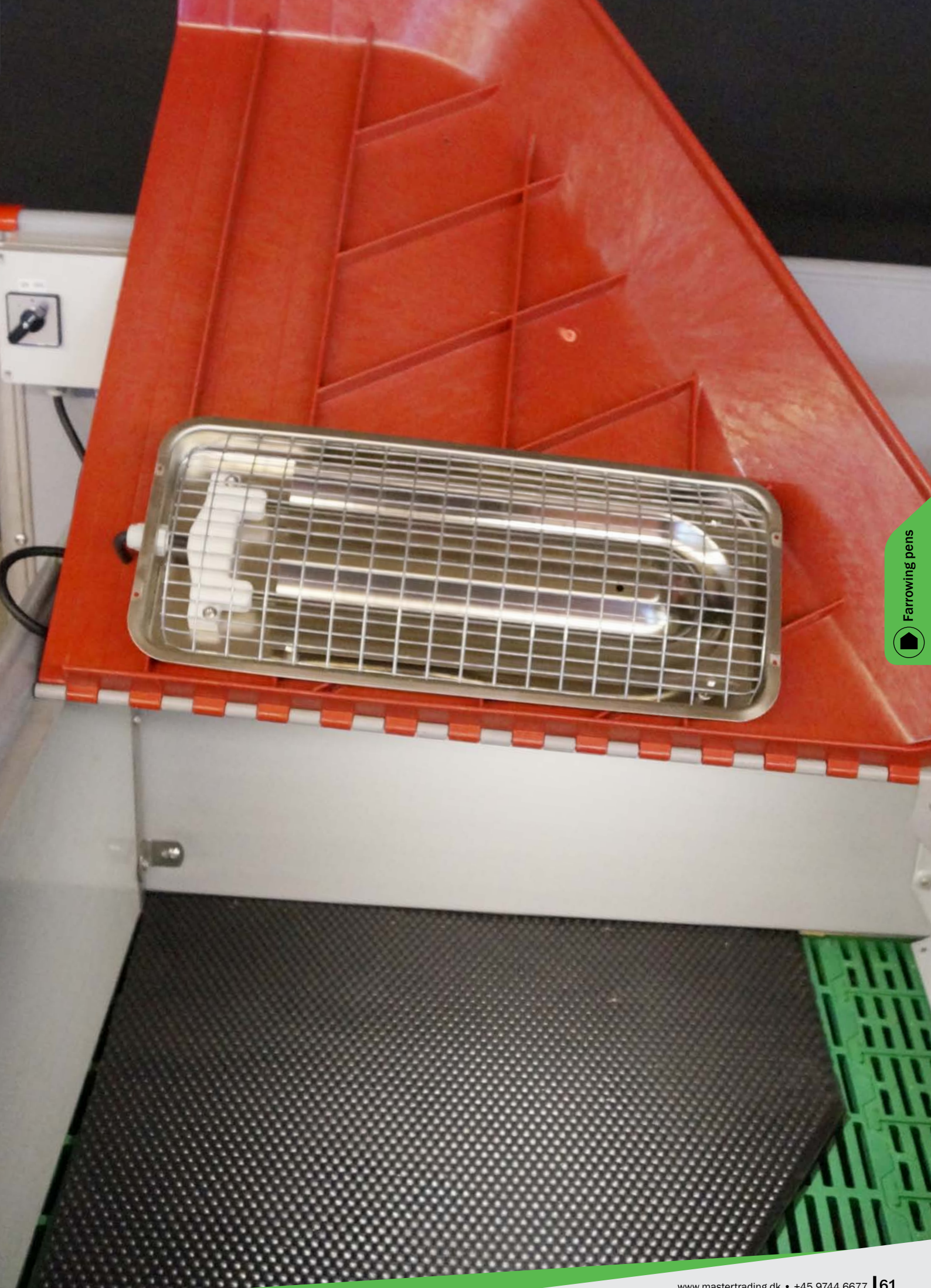



MANIPULATING MATERIALS

Manipulating materials to meet the pigs' need to investigate

MATERIALS

Fiber plate, plastic, stainless steel and galvanized steel

TYPES

For natural materials. i.e. straw or wood

- Different products that meet the requirements for providing manipulating materials for pigs
- Solutions for weaners, finishers and sows
- Manipulating materials minimize the risk of i.e. tail biting and other unintentional behaviour
- Manipulating materials support the pigs' natural behaviour

STRAW RACKS

- 2100641 STRAW HOLDER FOR FARROWING PEN, 360 X 350 X 200 MM, FIBER MATERIAL



- 4920526 STRAW HOLDER, FOR WEANERS AND FINISHERS, 88 X 514 X 205 MM, GALVANIZED
- 1920526 STRAW HOLDER, FOR SOWS, 1188 X 714 X 469 MM, GALVANIZED



- 4950541 STRAW HOLDER, FOR WEANERS AND FINISHERS, 480 X 603 X 295 MM, STAINLESS STEEL



HOLDER

- 4960518 HOLDER, FOR MANIPULATION MATERIALS, Ø125 MM, L=597 MM, PVC





FLOORING

Complete plastic and cast iron flooring program and related accessories. Well-proven through decades.

Our flooring product range is under constant development and optimization, and consists of multi-compatible plastic slats, cast iron slats, self-supporting slats and heating plates.

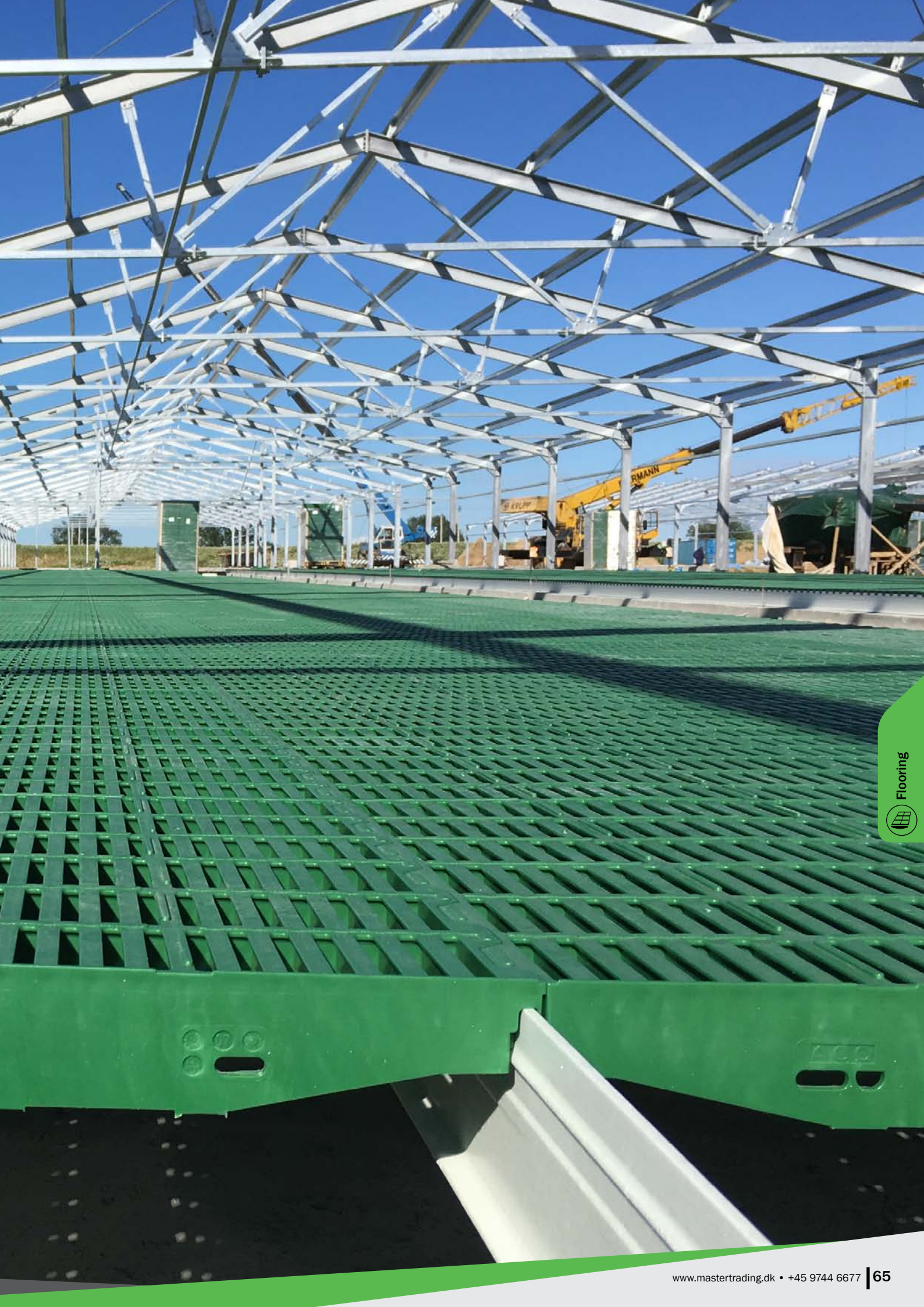

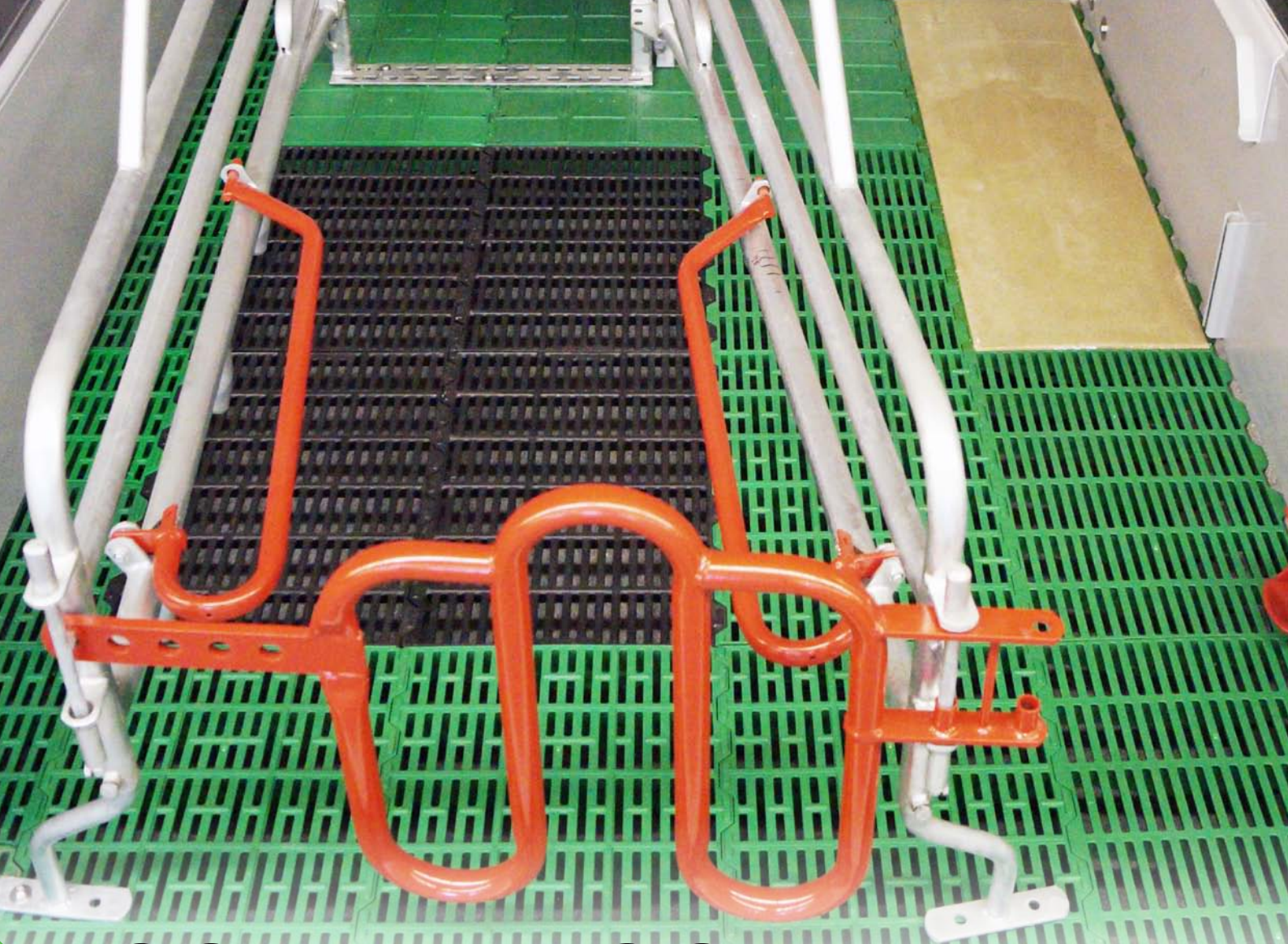

COMBI-FLOOR

Wide assortment of plastic slats, cast iron slats, supports and heating plates

- High quality plastic slats from our own production in Germany
- High level of flexibility - the components can be combined according to your needs
- No recycling materials used for our plastic slats - only pure PP
- Cast iron material: GGG40



Slats with 5% opening, designed to reduce the risk of pressure sores, and to ensure that the sows have a dry and cool area to stay in.



Special plastic slats for weaners with an innovative, textured surface, that helps to keep weaners warm and dry.



Special STEP system makes it possible to raise the sows' lying area and reduce the mortality of piglets.

STEP-SLAT, 50% OPENING

- 564061 STEP SLAT, FOR SOWS, 40X60 CM

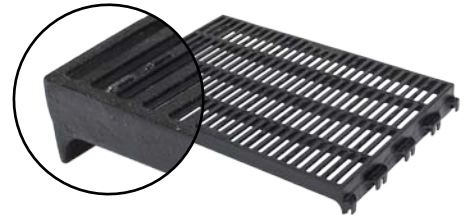

STEP-SLAT, CLOSED

- 564062 STEP SLAT, FOR SOWS, 40X60 CM

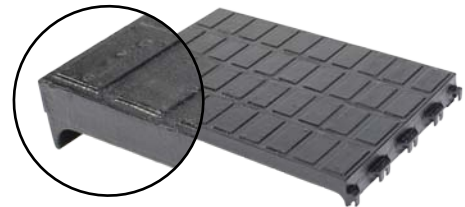

CAST IRON SLAT, 5% OPENING

- 566041 CAST IRON SLAT, FOR SOWS, 60X40 CM

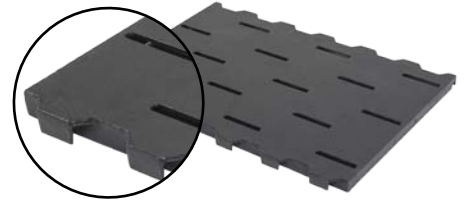

CAST IRON SLAT, CLOSED

- 564063 CAST IRON SLAT, FOR SOWS, 40X60 CM

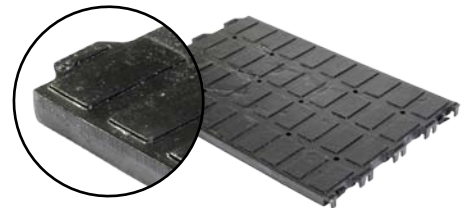

CAST IRON SLATS, 50% OPENING

- 561060 CAST IRON SLAT, FOR SOWS, 10X60 CM
- 564060 CAST IRON SLAT, FOR SOWS, 40X60 CM
- 566040 CAST IRON SLAT, FOR SOWS, 60X40 CM
- 566060 CAST IRON SLAT, FOR SOWS, 60X60 CM



CAST IRON SLATS, 50% OPENING, WITH PLUG

- 563060 CAST IRON SLAT WITH PLUG, FOR SOWS, 30X60 CM
- 563063 CAST IRON SLAT WITH PLUG, FOR SOWS, 60X60 CM

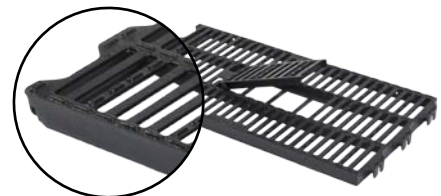

CLEANING PLUGS FOR CAST IRON SLATS

- 563061 PLUG FOR ITEM NO. 563060
- 563064 PLUG FOR ITEM NO. 566063

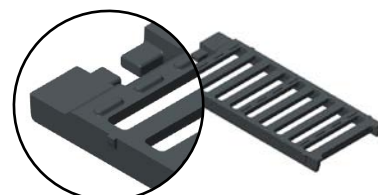

PLASTIC SLATS FOR COMBI-FLOOR

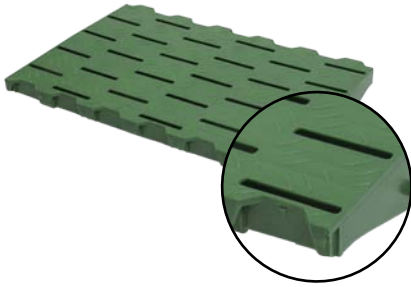

PLASTIC SLATS FOR WEANERS, 10% OPENING / CLOSED

- 18604 PLASTIC SLAT, FOR WEANERS, 60X40 CM, 10% OPENING
- 566260 PLASTIC SLAT, FOR WEANERS, 60X60 CM, 10% OPENING
- 566160 PLASTIC SLAT, FOR WEANERS, 60X60 CM, CLOSED

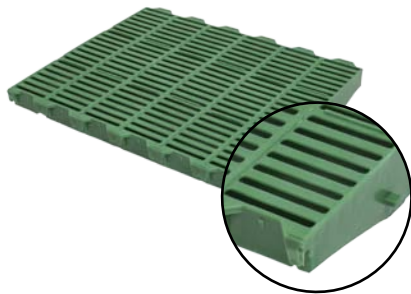

PLASTIC SLATS FOR WEANERS, 50% OPENING

- 09100 PLASTIC SLAT, FOR WEANERS, 60X40 CM
- 17384 PLASTIC SLAT, FOR WEANERS, 60X50 CM
- 566360 PLASTIC SLAT, FOR WEANERS, 60X60 CM



COMFORT PLATE

- 560310 POLYMER PLATE FOR FARROWING PEN, COMPLETE WITH 3 PCS. PLASTIC FRAMES
- 560300 PLASTIC GRATING FRAME 20X40 CM (3 PCS. PER 1 POLYMER PLATE)
- 560305 POLYMER PLATE FOR FARROWING PEN, 60X40 CM

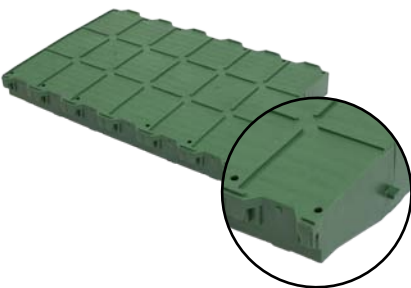

PLASTIC SLAT FOR SOWS, CLOSED

- 17383 PLASTIC SLAT, FOR SOWS, 60X40 CM

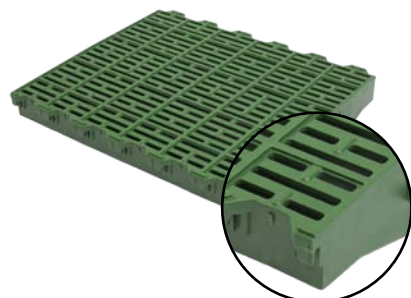

PLASTIC SLATS FOR SOWS, 50% OPENING

- 18054 PLASTIC SLAT, FOR SOWS, 10X40 CM
- 18094 PLASTIC SLAT, FOR SOWS, 30X20 CM
- 17328 PLASTIC SLAT, FOR SOWS, 30X30 CM
- 18721 PLASTIC SLAT, FOR SOWS, 30X60 CM
- 09102 PLASTIC SLAT, FOR SOWS, 60X40 CM
- 565060 PLASTIC SLAT, FOR SOWS, 60X50 CM

SUPPORTS

- 560193 FIBERGLASS SUPPORT, 120X32 MM, 5,9 M
- 560194 FIBERGLASS SUPPORT, 120X32 MM, SPECIAL LENGTH



- 560189 FIBERGLASS SUPPORT, 70X32 MM, 5,9 M
- 560190 FIBERGLASS SUPPORT, 70X32 MM, SPECIAL LENGTH



DELTA SUPPORTS

- 560285 FIBERGLASS SUPPORT, 120X30 MM, 2,85 M (DELTA)
- 560290 FIBERGLASS SUPPORT, 120X30 MM, 9 M (DELTA)
- 96676 FIBERGLASS SUPPORT, 120X30 MM, (DELTA), SPECIAL LENGTH



MOUNTING BRACKETS

- 96982 MOUNTING BRACKET, FOR DELTA FIBERGLASS SUPPORT
- 560192 MOUNTING BRACKET, FOR FIBERGLASS SUPPORT

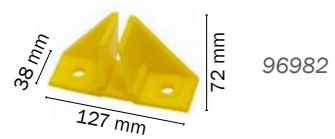

MAX. SPAN LENGTH, CM

Type	Weaners	Sows	With cast iron under the sow
70 x 32 mm	160	120	-
120 x 32 mm	280	240	260
Delta	310	270	280



WALL HOLDER

- 17234 WALL HOLDER, FOR FIBERGLASS- AND STEEL SUPPORTS



- 2900630 MOUNTING KIT, WALL BRACKET FOR FLOOR



- 2100619 Z-SUPPORT 135 MM, FOR FIBERGLASS SUPPORT 120 MM, COMPLETE



FOOT BRACKET

- 96980 FOOT BRACKET FOR SUPPORT LEG, FIBERGLASS SUPPORT



PVC PIPE

- 96981 PVC TUBE SUPPORT LEG, FIBERGLASS SUPPORTS, LENGTH 5 METER



- 562500 SLOTTED SHUTTER QUICK MODEL, SMOOTH SURFACE, LENGTH 250 CM
- 562502 SLOTTED SHUTTER QUICK MODEL, GROOVED SURFACE, LENGTH 250 CM

ACCESSORIES FOR COMBI-FLOOR

- 17667 FITTING FOR SOW SLATS, 40 CM, GREEN

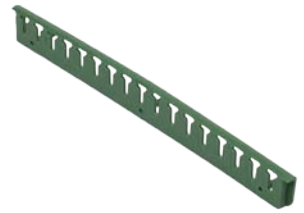

- 09105 FILLERS FOR PLASTIC SLATS



- 18083 CROSS-SECTION ADAPTER FOR PLASTIC SLATS, 20 CM



- 8500301 SPACER FOR PP FLOOR, 30 X 40 X 58,3 MM



- 18169 MUCK TRAP FOR FARROWING PENS, 38,5 X 18,5 CM, STAINLESS STEEL



- 01777 CLEANING PLUG, L13 X W10 X H15 CM

- 554164 CLEANING PLUG, L21 X W13 X H7 CM





WATER HEATING PLATES, POLYMER CONCRETE

- 12633 WATER HEATING PLATE, 120 X 50 CM, 120W, 1/2' PIPE, FEMALE THREAD
- 12630 WATER HEATING PLATE, 140 X 50 CM, 240W, 1/2' PIPE, FEMALE THREAD
- 12631 WATER HEATING PLATE, 120 X 40 CM, 240W, 1/2' PIPE, FEMALE THREAD



TEMPERATURE CONTROLLER

- 560312 TEMPERATURE CONTROLLER FOR WATER HEATING PLATE, FOR 2 CIRCUITS
- 560313 TEMPERATURE CONTROLLER FOR WATER HEATING PLATE, FOR 3 CIRCUITS
- 560314 TEMPERATURE CONTROLLER FOR WATER HEATING PLATE, FOR 4 CIRCUITS



ELECTRICAL HEATING PLATES, POLYMER CONCRETE

- 17582 ELECTRIC HEATING PLATE, 120 X 40 CM, 230V, 130W
- 18409 ELECTRIC HEATING PLATE, 120 X 50 CM, 230V, 180W
- 17792 ELECTRIC HEATING PLATE, 120 X 80 CM, 230V, 270W
- 18855 ELECTRIC HEATING PLATE, 140 X 50 CM, 230V, 180W



ELECTRIC HEATING PLATES, PLASTIC

- 18948 PLASTIC HEATING PLATE, 120 X 40E, 80W, RIGHT
- 18961 PLASTIC HEATING PLATE, 120 X 40E, 80W, LEFT



ACCESSORIES FOR HEATING PLATES

- 560515 TEMPERATURE CONTROLLER, FOR ELECTRIC POLYMER HEATING PLATE, 2200W, INCL. SENSOR
- 18962 TEMPERATURE CONTROLLER, FOR HEATING PLATE, 2200W



- 4960560 BRACKET KIT FOR HEATING PLATE
- 4960614 BRACKET KIT FOR HEATING PLATE, DELTA



Flooring





SELF-SUPPORTING CAST IRON SLATS

A sure-footed and comfortable solution for sows, weaners and finishers

Flooring

MATERIAL

Cast iron GGG40

DIMENSIONS

FARROWING PENS

Rib	10 mm
Opening	11 mm
Cleaning opening	40 mm

WEANERS & WEAN-TO-FINISH

Rib	13 mm
Opening	12 mm
Cleaning opening	40 mm

FINISHERS

Rib	30 mm
Opening	15 mm
Cleaning opening	40 mm

The healthy condition

- Slightly textured surface makes the slat non-slip
- T-shaped ribs ensure optimal manure passage

Minimum cleaning time

- Large cleaning opening, hard surface and minimum surface area

Better environment and economy

- Long durability, self-supporting = low mounting costs

SELF-SUPPORTING CAST IRON SLATS

CAST IRON SLATS FOR FARROWING PENS WITH CLEANING OPENING, 10/11 MM

- 560800 CAST IRON SLAT, FOR FARROWING PENS, 80 X 40 X 3 CM
- 560900 CAST IRON SLAT, FOR FARROWING PENS, 90 X 40 X 3 CM
- 561000 CAST IRON SLAT, FOR FARROWING PENS, 100 X 40 X 3 CM
- 561100 CAST IRON SLAT, FOR FARROWING PENS, 110 X 40 X 3 CM
- 549655 CAST IRON SLAT, FOR FARROWING PENS, 120 X 40 X 3 CM
- 561400 CAST IRON SLAT, FOR FARROWING PENS, 140 X 40 X 3 CM
- 561600 CAST IRON SLAT, FOR FARROWING PENS, 160 X 40 X 3 CM

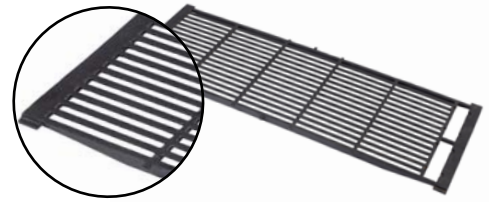

CAST IRON SLATS FOR WEANERS AND WEAN-TO-FINISH WITH CLEANING OPENING, 12/13 MM

- 561203 CAST IRON SLAT, FOR WEAN-TO-FINISH, 120 X 40 X 3 CM
- 549800 CAST IRON SLAT, FOR WEAN-TO-FINISH, 140 X 40 CM
- 549656 CAST IRON SLAT, FOR WEAN-TO-FINISH, 160 X 40 CM
- 561803 CAST IRON SLAT, FOR WEAN-TO-FINISH, 180 X 40 X 3 CM
- 549849 CAST IRON SLAT, FOR WEAN-TO-FINISH, 200 X 40 CM

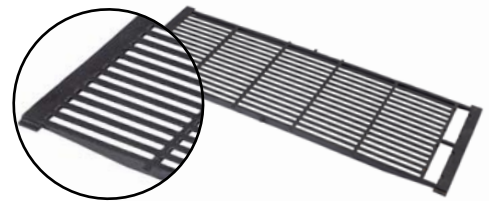

CAST IRON SLATS FOR FINISHERS WITH CLEANING OPENING, 30/15 MM

- 95816 CAST IRON SLAT, FOR FINISHERS, 160 X 40 CM

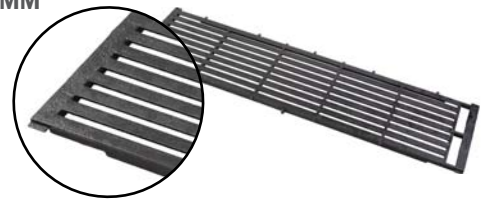

CAST IRON SLATS FOR SOWS WITH CLEANING OPENING, 10/11 MM

- 17339 CAST IRON SLAT, FOR SOWS, 80 X 50 CM
- 17341 CAST IRON SLAT, FOR SOWS, 100 X 50 CM, ANTI-SLIP
- 17342 CAST IRON SLAT, FOR SOWS, 120 X 50 CM, ANTI-SLIP

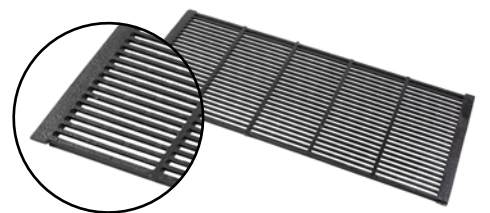

CAST IRON SLATS FOR SOWS WITH CLEANING OPENING, 26/16 MM

- 17253 CAST IRON SLAT, FOR SOWS, 100 X 50 CM, ANTI-SLIP
- 17197 CAST IRON SLAT, FOR SOWS, 80 X 75 CM, ANTI-SLIP

PLUGS

- 560111 PLUGS FOR CAST IRON SLATS 56XXXX



- 92630 PLUG FOR CAST IRON SLATS 92XXXX AND 54XXXX



BOARD PROFILES

The walls of our pens consist of boards made from PVC or fiber material. Applicable to both types of boards is that they are strong and stable and have completely smooth surfaces, which promotes a great hygiene.

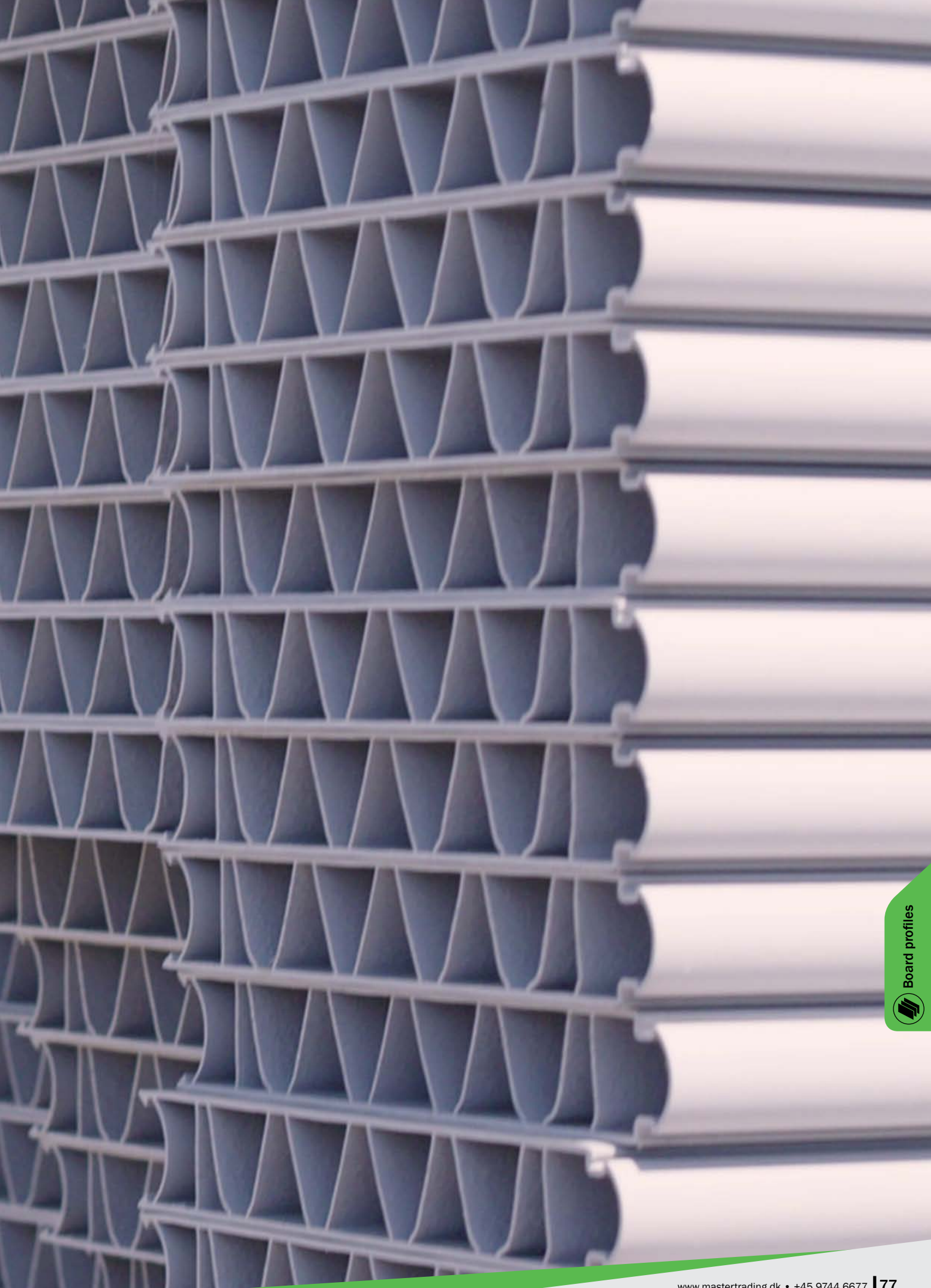



BOARD PROFILES

Durable and tight-fitting equipment

Board profiles

PVC BOARD PROFILES

MATERIAL PVC

HEIGHT

For 35 mm 250 mm
500 mm
750 mm

For 40 mm

200 mm
500 mm

U-PROFILES

MATERIAL Stainless steel

LENGTH Tailor-made dimensions

Hygiene and durability

- Tight, smooth and hard surface
- Rubber strips are adhered on outer side of board profiles for tighter joints
- Zig-zag lamellar structure provides torsional stiffness

CLEAN-O-FLEX® bottom profile

- Complements your CLEAN-O-FLEX® concept
- Sloped feet reduce the amount of manure on the equipment

“PROFF LINE STEEL” U-profile

- Inwards curved edges
- Variable distance between the holes in the side and back to provide great flexibility

PVC BOARD PROFILES 35 MM, HEIGHT: 250 MM

- 30099 35 X 250 MM, FEDER/NOT, PRICE PER M
- 30100 35 X 250 MM, FEDER/NOT, LENGTH 6 M

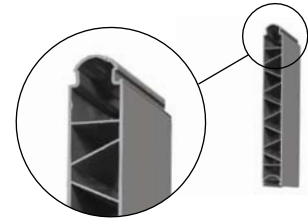

PVC BOARD PROFILES 35 MM, HEIGHT: 500 MM

- 30102 35 X 500 MM, FEDER/NOT, PRICE PER M
- 30103 35 X 500 MM, FEDER/NOT, LENGTH 6 M

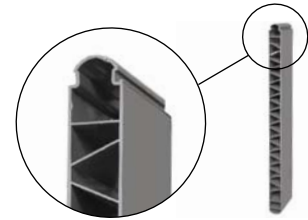

PVC BOARD PROFILES 35 MM, HEIGHT: 750 MM

- 30105 35 X 750 MM, FEDER/NOT, PRICE PER M
- 30106 35 X 750 MM, FEDER/NOT, LENGTH 6 M

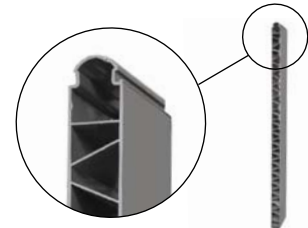

PVC BOARD PROFILES 35 MM

- 8535506 35 X 500 MM, FLAT/FLAT, LENGTH 6 M, PRICE PER M
- 8535756 35 X 750 MM, FLAT/FLAT, LENGTH 6 M, PRICE PER M
- 8535106 35 X 1000 MM, FLAT/FLAT, LENGTH 6 M, PRICE PER M

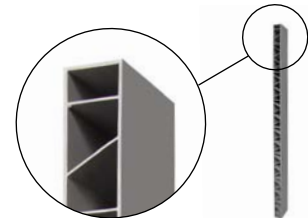

PVC BOARD PROFILES 40 MM, HEIGHT: 200 MM

- 8640206 40 X 200 MM, FEDER/NOT, LENGTH 6 M
- 9340461 40 X 200 MM, FEDER/NOT, PRICE PER M

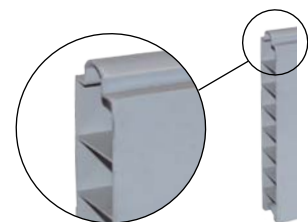

PVC BOARD PROFILES 40 MM, HEIGHT: 500 MM

- 8640506 40 X 500 MM, FEDER/NOT, LENGTH 6 M
- 9340471 40 X 500 MM, FEDER/NOT, PRICE PER M

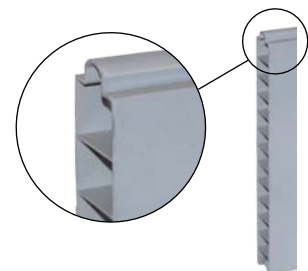



PROFILES FOR PVC BOARDS

- 2900358 U-PROFILE, LENGTH 6,5 M, PVC



- 2900359 HAT PROFILE, LENGTH 6,5 M, PVC



- 2900361 H-PROFILE, LENGTH 6,5 M, PVC



FIBER BOARD PROFILES

- 96997 COMPACT PLATE 10 MM, GREY, 4100 X 1300 MM

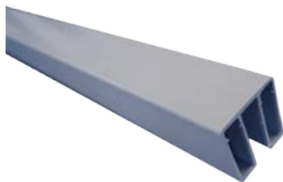

PROFILES FOR FIBER BOARDS

- 9340400 PROFILE FOR LAMINATE PLATE, PVC

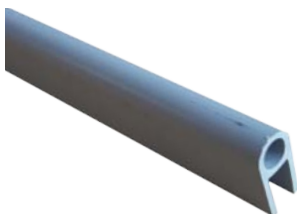

COVER FOR 8 MM PE HOSE

- 8500300 COVER FOR 8 MM PE-HOSE, FOR LAMINATE PLATE, 3 METER
- 30160 COVER FOR 8 MM PE-HOSE, 5900 MM

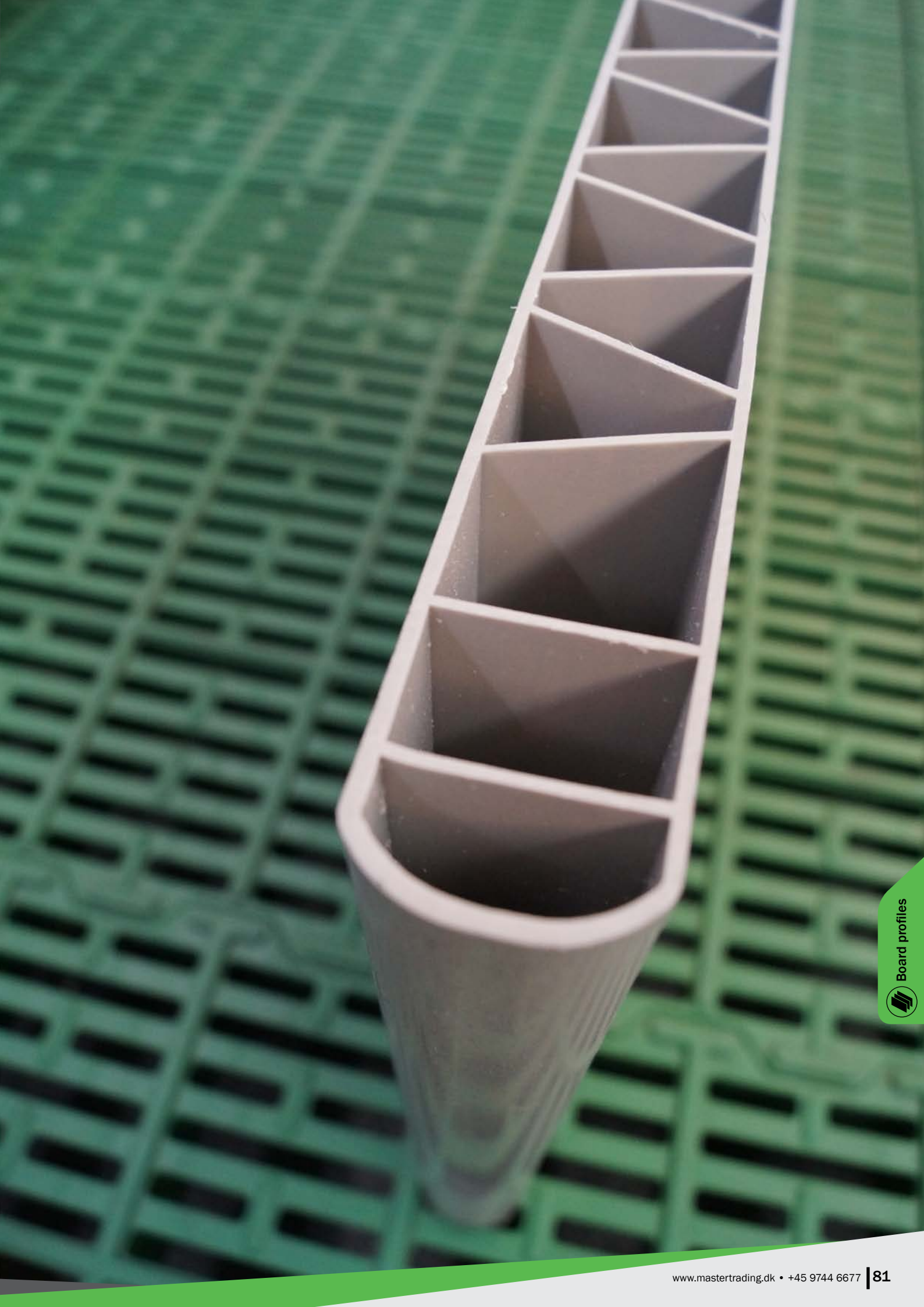



CLIMATE COVERS

Ensure a protective and draft-free area for weaners with the intelligent and waterproof climate covers made from lightweight, 15 mm PVC boards.

We offer flexible covers in several different variants.





FLEXCOVER®

CLIMATE COVER

Climate cover made of 15 mm PVC board profiles

DEPTH* (CM)	SECTIONS (CM)
85, straight	25 / 50
110, straight	50 / 50 25 / 75
116, straight	25 / 50 / 25
135, straight	50 / 75
160, straight	75 / 75
110, sloped	25 / 75
135, sloped	50 / 75

*Maximum width is 300 cm. If the width exceeds 300 cm, an extra support post is required (3100314)

Several design options for covers for piglets

- PVC with rounded profiles all over; no sharp edges
- Light, but at the same time durable construction with 15 mm plastic board profiles
- Tight fittings ensure top hygiene and easy cleaning
- Developed for modern pig production with many washings
- Hinge rails with flexible rubber hinges ensure a draft-free environment
- Many built-in options with 25, 50 and 75 cm board profiles in combination with flexible hinge rails

FLEXCOVER 85 CM, 25/50

- 31488-2 2-PARTS 25/50, DEPTH 85 CM, 0-2500 MM
- 31488 2-PARTS 25/50, DEPTH 85 CM, 2500-3000 MM
- 4900586 2-PARTS 25/50, DEPTH 85 CM, 3000 MM, SALES SET
- 4900585 2-PARTS 25/50, DEPTH 85 CM, 2500 MM, SALES SET

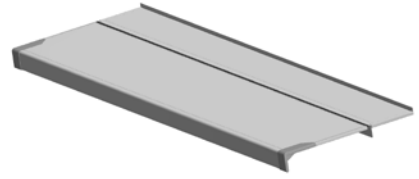

FLEXCOVER 110 CM, 50/50

- 31492-2 2-PARTS 50/50, DEPTH 110 CM, 0-2500 MM
- 31492 2-PARTS 50/50, DEPTH 110 CM, 2500-3000 MM
- 4900611 2-PARTS 50/50, DEPTH 110 CM, 3000 MM, SALES SET
- 4900610 2-PARTS 50/50, DEPTH 110 CM, 2500 MM, SALES SET

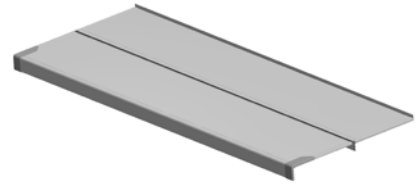

FLEXCOVER 110 CM, 25/75

- 31485-2 2-PARTS 25/75, DEPTH 110 CM, 0-2500 MM
- 31485 2-PARTS 25/75, DEPTH 110 CM, 2500-3000 MM
- 4900613 2-PARTS 25/75, DEPTH 110 CM, 3000 MM, SALES SET
- 4900612 2-PARTS 25/75, DEPTH 110 CM, 2500 MM, SALES SET

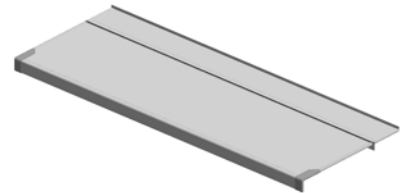

FLEXCOVER 135 CM, 50/75

- 31486-2 2-PARTS 50/75, DEPTH 135 CM, 0-2500 MM
- 31486 2-PARTS 50/75, DEPTH 135 CM, 2500-3000 MM
- 4900636 2-PARTS 50/75, DEPTH 135 CM, 3000 MM, SALES SET
- 4900635 2-PARTS 50/75, DEPTH 135 CM, 2500 MM, SALES SET

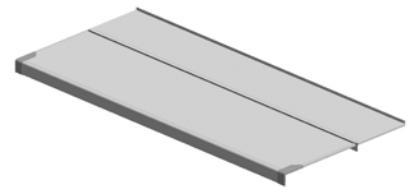

FLEXCOVER 160 CM, 75/75

- 31487-2 2-PARTS 75/75, DEPTH 160 CM, 0-2500 MM
- 31487 2-PARTS 75/75, DEPTH 160 CM, 2500-3000 MM
- 4900661 2-PARTS 75/75, DEPTH 160 CM, 3000 MM, SALES SET
- 4900660 2-PARTS 75/75, DEPTH 160 CM, 2500 MM, SALES SET

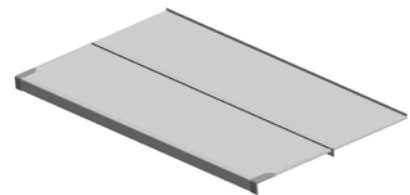

FLEXCOVER 116 CM, 25/50/25

- 31493-2 3-PARTS 25/50/25, DEPTH 116 CM, 0-2500 MM
- 31493 3-PARTS 25/50/25, DEPTH 116 CM, 2500-3000 MM
- 4900747 3-PARTS 25/50/25, DEPTH 116 CM, 3000 MM, SALES SET
- 4900716 3-PARTS 25/50/25, DEPTH 116 CM, 2500 MM, SALES SET

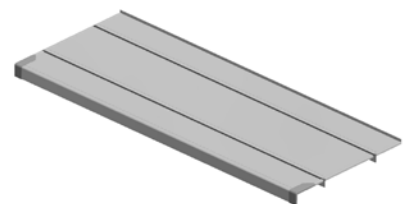

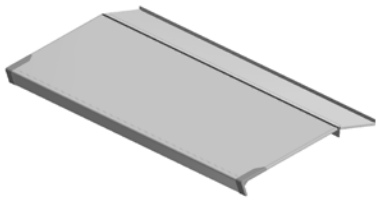

FLEXCOVER 110 CM, 25/75, SLOPED

- 31489-2 2-PARTS 25/75, DEPTH 110 CM, 0-2500 MM
- 31489 2-PARTS 25/75, DEPTH 110 CM, 2500-3000 MM
- 4900711 2-PARTS 25/75, DEPTH 110 CM, 3000 MM, SALES SET
- 4900710 2-PARTS 25/75, DEPTH 110 CM, 2500 MM, SALES SET

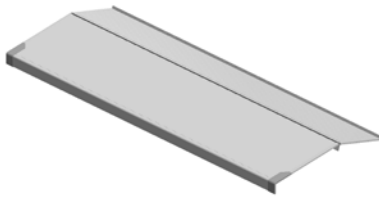

FLEXCOVER 135 CM, 50/75, SLOPED

- 31490-2 2-PARTS 50/75, DEPTH 135 CM, 0-2500 MM
- 31490 2-PARTS 50/75, DEPTH 135 CM, 2500-3000 MM
- 4900736 2-PARTS 50/75, DEPTH 135 CM, 3000 MM, SALES SET
- 4900735 2-PARTS 50/75, DEPTH 135 CM, 2500 MM, SALES SET

ACCESSORIES FOR FLEXCOVERS

- 31378 HAT PROFILE, FOR 85 CM FLEXCOVER
- 31391 V-RAIL, FOR 85 CM FLEXCOVER, ON WALL
- 31392 V-RAIL, FOR 85 CM FLEXCOVER, ON BOARD PROFILE

- 31375 HAT PROFILE, FOR 110 CM FLEXCOVER
- 31385 V-RAIL, FOR 110 CM FLEXCOVER, ON WALL
- 31386 V-RAIL, FOR 110 CM FLEXCOVER, ON BOARD PROFILE

- 31381 HAT PROFILE, FOR 116 CM FLEXCOVER
- 31383 V-RAIL, FOR 116 CM FLEXCOVER, ON WALL
- 31384 V-RAIL, FOR 116 CM FLEXCOVER, ON BOARD PROFILE

- 31376 HAT PROFILE, FOR 135 CM FLEXCOVER
- 31387 V-RAIL, FOR 135 CM FLEXCOVER, ON WALL
- 31388 V-RAIL, FOR 135 CM FLEXCOVER, ON BOARD PROFILE

- 31377 HAT PROFILE, FOR 160 CM FLEXCOVER
- 31389 V-RAIL, FOR 160 CM FLEXCOVER, ON WALL
- 31390 V-RAIL, FOR 160 CM FLEXCOVER, ON BOARD PROFILE

- 31393 V-RAIL, FOR 110 CM SLOPED FLEXCOVER, ON WALL
- 31394 V-RAIL, FOR 110 CM SLOPED FLEXCOVER, ON BOARD PROFILE, SINGLE
- 31395 V-RAIL, FOR 110 CM SLOPED FLEXCOVER, ON BOARD PROFILE, DOUBLE

- 31396 V-RAIL, FOR 135 CM SLOPED FLEXCOVER, ON WALL
- 31397 V-RAIL, FOR 135 CM SLOPED FLEXCOVER, ON BOARD PROFILE, SINGLE
- 31398 V-RAIL, FOR 135 CM SLOPED FLEXCOVER, ON BOARD PROFILE, DOUBLE



OPENING SET FOR FLEXCOVER

- 92509 OPENING SET FOR FLEXCOVER, PER PEN



BOLT KIT FOR FLEXCOVER

- 39800 BOLT KIT, FOR 1 FLEXCOVER, AGAINST WALL
- 39801 BOLT KIT, FOR 2 FLEXCOVERS, AGAINST BOARD PROFILE
- 39802 BOLT KIT, FOR 1 FLEXCOVER, AGAINST BOARD PROFILE



GLUE PEVICOL

- 23900112 GLUE PEVICOL, 0,5 KG, FOR APPROX. 25 CLIMATE COVERS



SUPPORT

- 3100314 SUPPORT, FOR DOUBLE FLEXCOVER

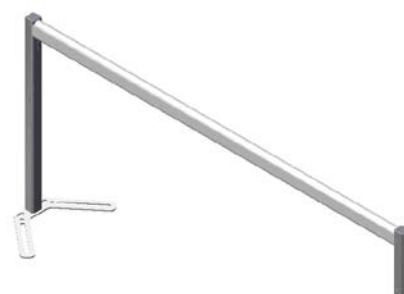



TROUGHS

Troughs for all sizes - weaners, finishers and sows. Optimized shaping adapted to the feed intake behavior of the pigs. High level of hygiene, thanks to closed edges and smooth surfaces.

Troughs and sow troughs in stainless steel, and more than 50 years of experience with producing polymer concrete troughs.

We are proud to present our trough program.





Troughs

TROUGHs

STAINLESS STEEL

Made of strong stainless steel. Can be used for liquid feeding walls

MATERIAL	1 mm stainless steel
LENGTH	60-590 cm
<i>WEAN-TO-FINISH, FINISHERS, YOUNG SOWS - DOUBLE TROUGH</i>	
Volume per meter	49 l
Height	14,5 cm
Width upper/lower	49,7 cm / 20 cm
<i>WEAN-TO-FINISH, FINISHERS, YOUNG SOWS - SINGLE TROUGH</i>	
Volume per meter	24,5 l
Height	14,5 cm
Width upper/lower	24 cm / 7 cm
<i>WEANERS - DOUBLE TROUGH</i>	
Volume per meter	38 l
Height	12 cm
Width upper/lower	43 cm / 20 cm
<i>WEANERS - SINGLE TROUGH</i>	
Volume per meter	16 l
Height	12 cm
Width upper/lower	20 cm / 6 cm

Well-designed and reliable

- **Animal welfare and hygiene**
Completely smooth surface on the inside = minimal risk of injuries to the animals and minimal accumulation of feed residue
- **Suited for both dry- and liquid feeding**
- **Minimum feed waste**
Inverted edges
- **Easy cleaning**
the troughs are mounted free of the floor allowing washing underneath them

STAINLESS STEEL TROUGHS

LOW STAINLESS STEEL TROUGHS FOR BOXES

- 96181 LOW STAINLESS STEEL TROUGH, FOR PLASTIC JOINT
- 96182 LOW STAINLESS STEEL TROUGH, WITH WELDED GABLE
- 96203 BRACKET PLASTIC END PIECE, FOR LOW TROUGHS
- 96202 BRACKET CONTINUOUS, FOR HIGH AND LOW TROUGHS

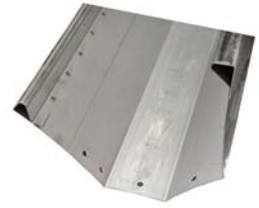
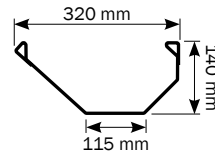

HIGH STAINLESS STEEL TROUGHS FOR BOXES

- 96180 HIGH STAINLESS STEEL TROUGH, FOR PLASTIC JOINT
- 96183 HIGH STAINLESS STEEL TROUGH, WITH WELDED GABLE
- 96201 BRACKET, PLASTIC END PIECE FOR HIGH TROUGHS
- 96202 BRACKET, CONTINUOUS FOR HIGH AND LOW TROUGHS

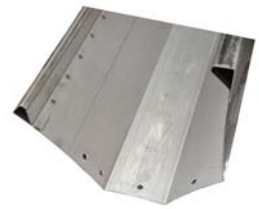
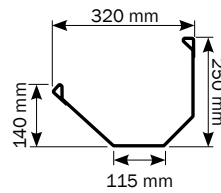

END PIECE FOR STAINLESS STEEL TROUGH

- 31025 END PIECE KIT FOR 1 STAINLESS STEEL TROUGH, PLASTIC



ASSEMBLY KIT FOR STAINLESS STEEL TROUGH

- 31030 ASSEMBLY KIT FOR 1 STAINLESS STEEL TROUGH, PLASTIC



STAINLESS STEEL TROUGHS FOR INN-O-WALL, LIQUID FEEDING WALL - SINGLE

- 39218 LIQUID FEEDING TROUGH, SINGLE, FOR WEANERS
- 39211 LIQUID FEEDING TROUGH, SINGLE, FOR FINISHERS

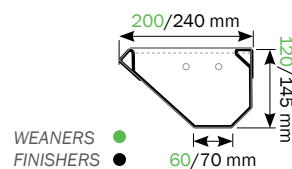

STAINLESS STEEL TROUGHS FOR INN-O-WALL, LIQUID FEEDING WALL - DOUBLE

- 39215 LIQUID FEEDING TROUGH, DOUBLE, FOR WEANERS
- 39234 LIQUID FEEDING TROUGH, DOUBLE, FOR FINISHERS

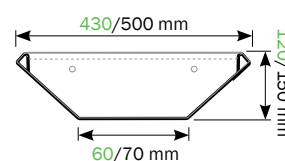



FOOT BRACKETS FOR TROUGHS

- 31000 BRACKET SET FOR DOUBLE TROUGH, FINISHERS
- 31002 SUPPORT LEG FOR DOUBLE TROUGH, WEANERS



- 31001 BRACKET SET FOR SINGLE TROUGH, FINISHERS
- 31003 SUPPORT LEG FOR SINGLE TROUGH, WEANERS



ADAPTER FOR SUPPORT LEG

- 30053 ADAPTER FOR SUPPORT LEG, 35 MM BOARD PROFILE
- 8530052 ADAPTER FOR SUPPORT LEG, 50 MM BOARD PROFILE



WALL BRACKETS FOR SINGLE STEEL TROUGH

- 31050 WALL BRACKET FOR SINGLE TROUGH, AGAINST WALL



- 31051 WALL BRACKET FOR SINGLE TROUGH, AGAINST BOARD PROFILE



- 31052 WALL BRACKET FOR SINGLE TROUGH, DOUBLE, AGAINST BOARD PROFILE



BIOLINE TROUGHS

- 39902 5 X 2 EATING PLACES, 750 X 1100 X 430 MM
- 39912 7 X 2 EATING PLACES, 750 X 1600 X 430 MM
- 39922 9 X 2 EATING PLACES, 750 X 2000 X 430 MM





Troughs

TROUGHs

POLYMER CONCRETE

Your guarantee for optimal profit, animal welfare and working environment in your pig production

MATERIAL
Polymer concrete

LENGTH
100 / 120 cm

- Smooth surface to prevent accumulation of bacteria and manure
- Easy to clean
- Easy to mount
- Flexible; can be adjusted at the mounting place
- The most used trough principle in Europe for the past 30+ years
- 4 times stronger than regular concrete



TS 25

- 02564 TS 25, 100 CM
- 02566 END TROUGH FOR TS 25
- 02850 PARTITION FOR TS 25

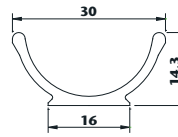

TS 28V

- 18444 TS 28V, 100 CM
- 18445 PARTITION FOR TS 28V

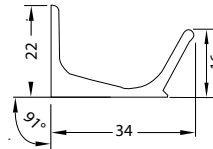

TS 30

- 01605 TS 30, 100 CM
- 17096 END TROUGH FOR TS 30, 100 CM
- 17097 END TROUGH FOR TS 30, 65 CM
- 01664 PARTITION FOR TS 30

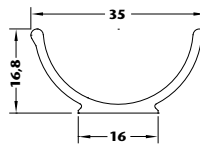

TS 35

- 01667 TS 35, 100 CM
- 17081 END TROUGH FOR TS 35, 50 CM, RIGHT
- 17080 END TROUGH FOR TS 35, 50 CM, LEFT
- 01670 PARTITION FOR TS 35

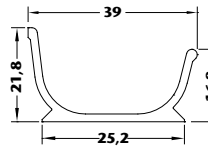

TS 36

- 02571 TS 36, 100 CM
- 17098 END TROUGH FOR TS 36, 50 CM, RIGHT
- 17099 END TROUGH FOR TS 36, 50 CM, LEFT
- 02605 PARTITION FOR TS 36

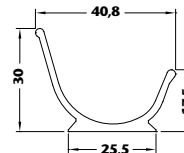

TS 41

- 03191 TS 41, 100 CM
- 01595 END TROUGH FOR TS 41, 100 CM
- 01596 END TROUGH FOR TS 41, 65 CM
- 03204 PARTITION FOR TS 41

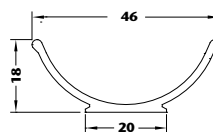

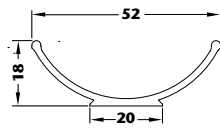

TS 47

- 01585 TS 47, 100 CM
- 03258 TS 47 WITH CLEANING OPENING, 100 CM
- 01586 END TROUGH FOR TS 47, 100 CM
- 01587 END TROUGH FOR TS 47, 65 CM

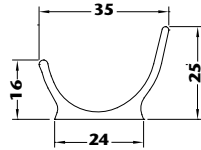

TROUGH 110

- 554157 TROUGH, 110, 120 CM
- 554170 PARTITION FOR TROUGH 110

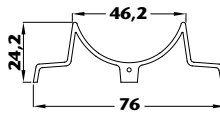

105-R

- 554201 TROUGH 105-R, 120 CM
- 554203 END TROUGH FOR 105-R, 120 CM



TS 35-50

- 09550 SINGLE TROUGH T35-50, CONCRETE ENCASING



TS 35-60

- 09552 SINGLE TROUGH T35-60, CONCRETE ENCASING



TS 36-49,5

- 18333 SINGLE TROUGH T39-49,5, WITH PLUG

POLYESTER GLUE

- 02163 0,5 KG, 150 G PER JOINT, 250 G PER PARTITION
- 18435 4 KG, 150 G PER JOINT, 250 G PER PARTITION
- 560308 ACO FUNKI COMPONENT FIX



Troughs

MANURE PLUGS

- | | | |
|---------|--|--------------------|
| ■ 17334 | MANURE PLUG DN 150, | A: 205 X B: 150 MM |
| ■ 17016 | MANURE PLUG DN 200 | A: 232 X B: 181 MM |
| ■ 17161 | MANURE PLUG DN 250 | A: 284 X B: 233 MM |
| ■ 17162 | MANURE PLUG DN 300 | A: 339 X B: 284 MM |
| ■ 18404 | MANURE PLUG DN 150
WITH FLAT HANGER 155X30 MM | A: 205 X B: 150 MM |
| ■ 18918 | MANURE PLUG DN 150,
WITH FLAT HANGER 50X30 MM | A: 205 X B: 150 MM |
| ■ 18496 | MANURE PLUG DN 150
WITH FLAT HANGER 100X25 MM | A: 205 X B: 150 MM |

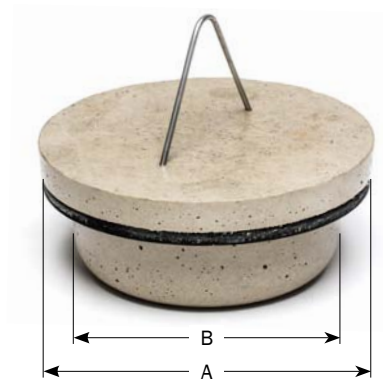

FEED TABLES FOR CATTLE

- | | | |
|---------|--------------------|---------------------------|
| ■ 09655 | FEED TABLE, KL 60 | L: 100 X H: 17 X B: 58 CM |
| ■ 17385 | FEED TABLE, KL 70S | L: 100 X H: 6 X B: 69 CM |
| ■ 02326 | FEED TABLE, KL 70 | L: 100 X H: 17 X B: 70 CM |
| ■ 09693 | FEED TABLE, KL 72 | L: 100 X H: 27 X B: 72 CM |
| ■ 09657 | FEED TABLE, KL 80 | L: 100 X H: 22 X B: 80 CM |
| ■ 18268 | FEED TABLE, KL 100 | L: 70 X H: 27 X B: 100 CM |



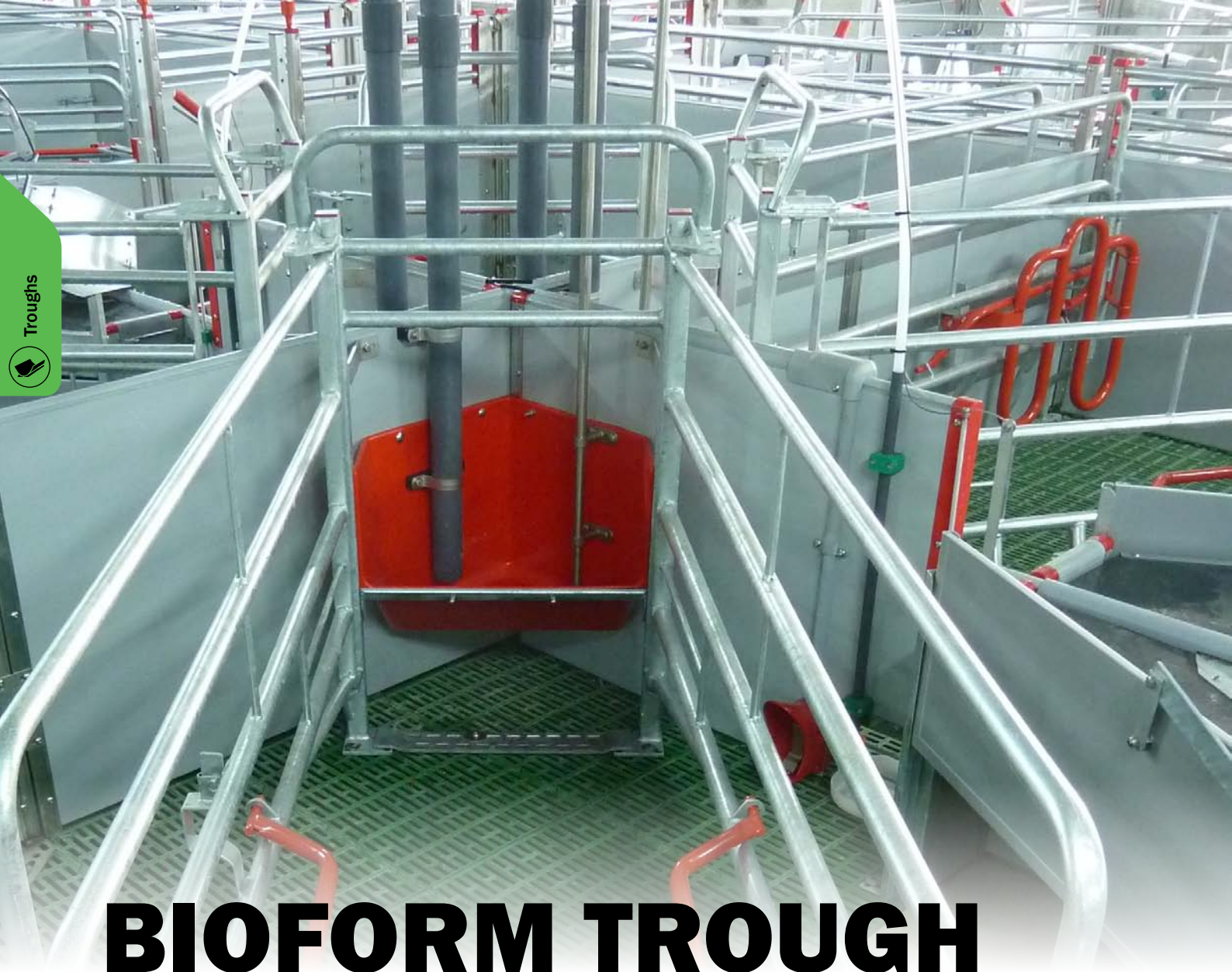

BIOFORM TROUGH

PVC trough in farrowing pens for loose sows

MATERIAL
PP

VOLUME
19,5 L / 21 L

- Strong trough for sows
- Made from acid-proof materials
- Minimum feed waste
- Fits to U-profile in the corner
- Tight fit against the wall / pen equipment

BIOFORM TROUGH

BIOFORM TROUGHS

- 2960565 BIOFORM III, PLASTIC CORNER TROUGH, 19,5 L



- 2960495 BIOFORM MULTI, SOW FEEDER, 21 L



BIOFORM CORNER - 2960565

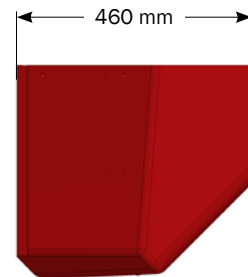
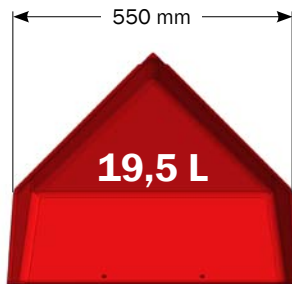
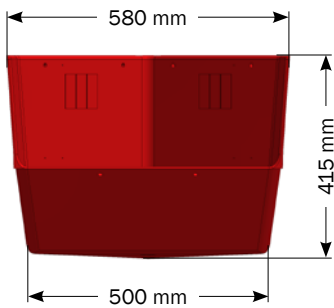

BIOFORM MULTI - 2960495

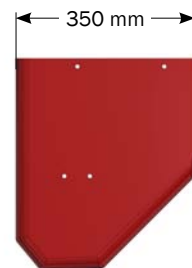
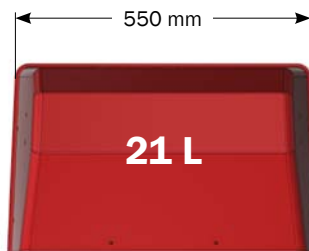
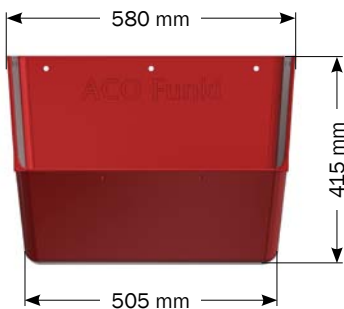



DRY FEEDING SYSTEM

ACO FUNKI was the first in the world to develop and start producing dry feeding systems.

The production dates all the way back to the mid 1960's, and ever since, the development has been ongoing, resulting in a strong and comprehensive dry feeding program.



DRY FEEDING SYSTEM

Easy inspection, uniform feed supply and strong reliability

MASTER CHAIN

SIZE (MM)	PULL	CAPACITY (KG/HR)
38	Chain	400
50	Chain	700
60	Chain	1000
76	Chain	2000

POWERLINE

SIZE (MM)	PULL	CAPACITY (KG/HR)
38	Chain	400
60	Chain	1000

WIRE

SIZE (MM)	PULL	CAPACITY (KG/HR)
38	Wire	400
50	Wire	700
60	Wire	1000

- **Easy maintenance**
The front part is made of transparent plastic. Standard motor with few wear parts
- **Long durability**
V-belt drive = elastic, even pull with minimum wear
- **High security**
Emergency stop
- **Low energy consumption**
Powerful transmission with high efficiency and low ration, which at the same time prevents overheating
- **Adjustable feed pull out**
Prevents bridging
- **Optimal utility**
Adjustable dispensing, for both meal and pellets

CORNERS

- 86205 CORNER, FOR Ø38 MM SYSTEM
- 86193 CORNER, FOR Ø50 MM SYSTEM
- 0213-123 CORNER, FOR Ø60 MM SYSTEM
- 0213-200 CORNER, FOR Ø60 MM SYSTEM, STAINLESS STEEL
- 86186 CORNER, FOR Ø76 MM SYSTEM



CORNER WHEELS

- 86238 CORNER WHEEL, Ø38 MM
- 86237 CORNER WHEEL, Ø50 MM
- 0213-202 CORNER WHEEL, Ø60 MM, WITH SHAFT AND BEARINGS
- 86239 CORNER WHEEL, Ø60 MM, COMPLETE
- 86241 CORNER WHEEL, Ø76 MM, COMPLETE



FEED TUBES

- 0116-100 FEED TUBE, Ø38 MM, LENGTH 5 M
- 86112 FEED TUBE, Ø50 MM, LENGTH 5 M
- 0214-107 FEED TUBE, Ø60 MM, LENGTH 6 M
- 86135 FEED TUBE, Ø76 MM, LENGTH 6 M
- 0214-109 FEED TUBE, Ø60 MM, LENGTH 6 M, STAINLESS STEEL



CONNECTION JOINTS

- 86125 CONNECTION JOINT, FOR Ø38 MM FEED TUBE, COMPLETE
- 86115 CONNECTION JOINT, FOR Ø50 MM FEED TUBE, COMPLETE
- 86100 CONNECTION JOINT, FOR Ø60 MM FEED TUBE, COMPLETE
- 86109 CONNECTION JOINT, FOR Ø60 MM FEED TUBE, COMPLETE, STAINLESS STEEL
- 86137 CONNECTION JOINT, FOR Ø76 MM FEED TUBE, COMPLETE



CONICAL DRILL

- 86148 CONICAL DRILL, FOR FEED TUBE Ø16 - 30,5 MM





MASTER CHAIN® “ANTI TWIST”

- 86086 MASTER CHAIN, FOR Ø38 MM FEED TUBE
- 86084 MASTER CHAIN, FOR Ø50 MM FEED TUBE
- 86085 MASTER CHAIN, FOR Ø60 MM FEED TUBE
- 86087 MASTER CHAIN, FOR Ø76 MM FEED TUBE



POWERLINE® CHAIN

- 0117-200 POWERLINE CHAIN, FOR Ø38 MM
- 0117-225 POWERLINE CHAIN, FOR Ø60 MM



WIRE

- 0117-004 WIRE, FOR Ø38 MM
- 85982 WIRE, FOR Ø50 MM
- 0214-104 WIRE, FOR Ø60 MM

SWIVELS

- 86033 SWIVEL, FOR MASTER CHAIN
- 39408080 SWIVEL, FOR POWERLINE CHAIN



JOINT LINKS

- 86029 JOINT LINK, FOR MASTER CHAIN



- 0117-205 JOINT LINK, FOR POWERLINE CHAIN



- 0117-113 JOINT LINK, FOR CONVEYOR CABLE Ø38 AND Ø50 MM
- 0215-117 JOINT LINK, FOR CONVEYOR CABLE Ø60 MM





FASTENERS

Bolts, screws, plugs, hinges, handles, holders, clamps, brackets, fittings...

- We carry all you need within fasteners for your pen equipment project.

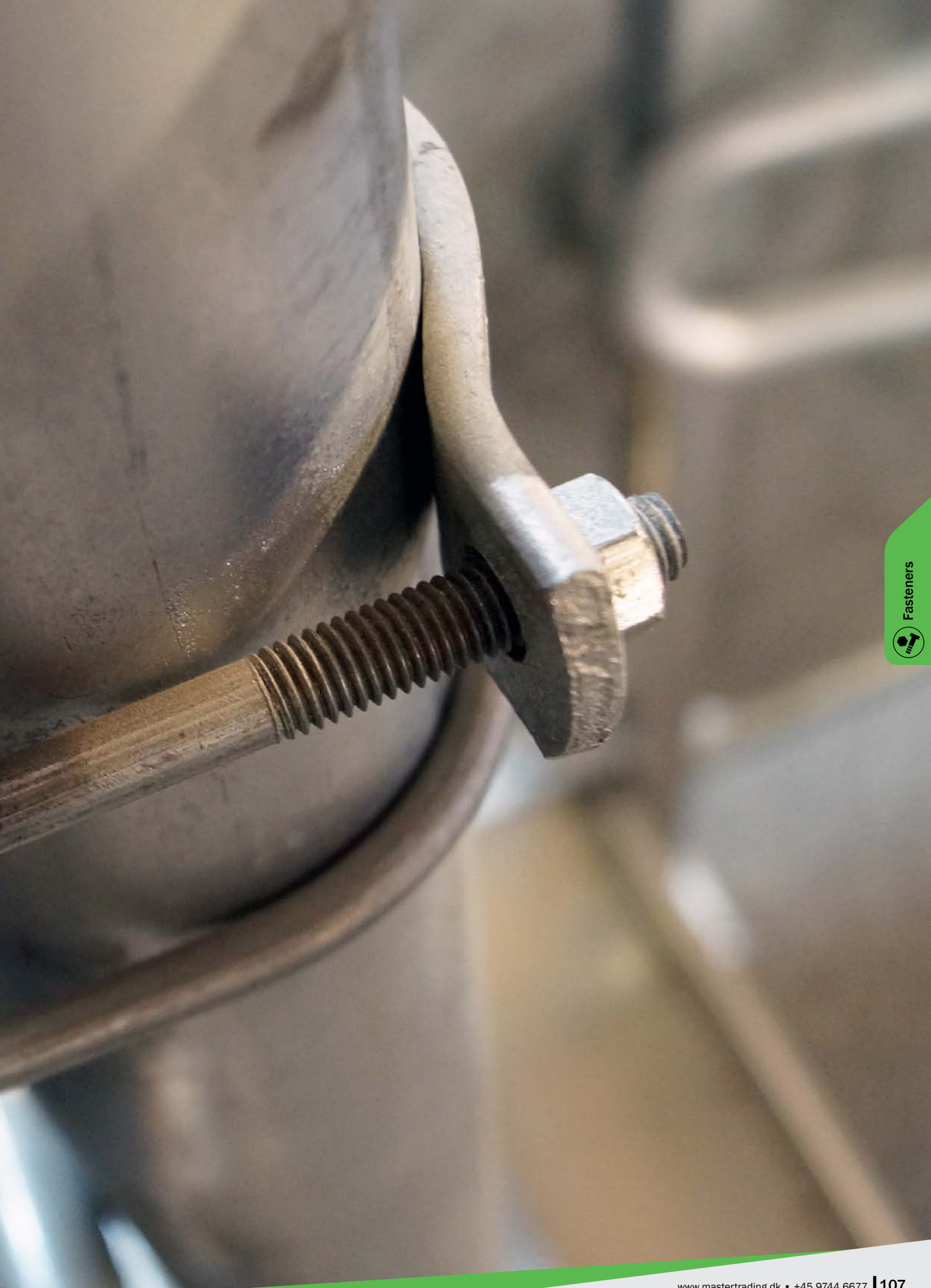



FASTENERS

A complete selection of fasteners to complement our equipment program

MATERIALS

Galvanized steel, stainless steel or strong plastic

- Bolts and anchors for flooring
- INN-O-PLUG for fastening of board profiles
- Retaining tools
- Clamps and brackets for water pipes - incl. MASTER CLAMP
- Hinges and handles
- Foot brackets and stabilisations posts

FIXINGS FOR CONCRETE SLATS

- 30871 T-ANCHOR FOR INN-O-PLUG, M10, 80-100 MM
- 30875 T-ANCHOR FOR INN-O-PLUG, M10, 100-120 MM

- 30872 BUTTON HEAD TORX 50, FOR T-ANCHOR, A2 BOLT, 10X90 MM
- 30310080 BUTTON HEAD TORX 50, M10X80 MM, STAINLESS STEEL

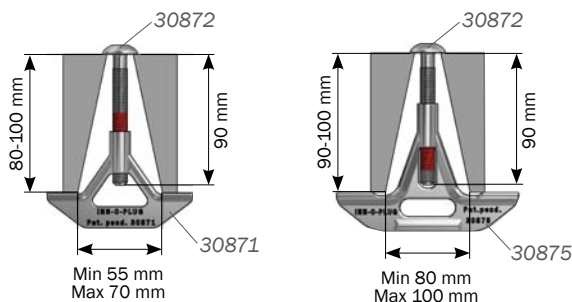

T-ANCHOR



TORX

- 90100079 DISPLACED T-BOLT, 50 MM



- 90100078 T-BOLT, M10, STAINLESS STEEL



- 30847 ANCHOR, FOR PLASTIC SLATS, M8
- 90130847 ANCHOR, FOR PLASTIC SLATS, M8

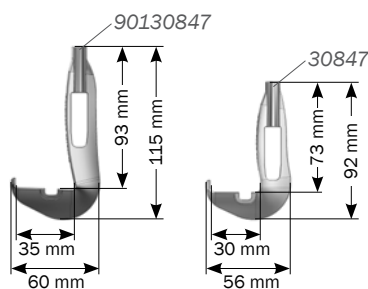

- 30887 INN-O-PLUG, M8 X 120, BH TX50 A2
- 30888 INN-O-PLUG, M8 X 90, BH TX50 A2 FT
- 30889 INN-O-PLUG, M8 X 65, BH TX50 A2 FT



FASTENERS



- 30308071 BUTTONHEAD SCREW TORX 50, M8X70 MM, WITHOUT WASHER, STAINLESS STEEL

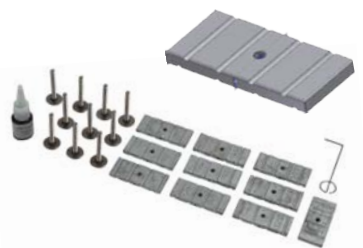

- 1900241 BOLT-ON FITTINGS, FOR CAST IRON SLATS, LARGE



FIXINGS FOR PLASTIC SLATS

- 17095 SLAT ANCHOR, 8 MM, GREEN, 10 PCS./PACK
- 17129 SLAT ANCHOR, 10 MM, GREEN 10 PCS./PACK



- 18958 RHOMB SCREW-ANCHOR, PIGLET SLATS, 10 PCS./PACK



FIXINGS AGAINST CONCRETE / WALL

- 39406050 CONCRETE SCREW 6,5X50 MM, STAINLESS STEEL
- 67451 CONCRETE SCREW TORX 50, 10X70 MM, STAINLESS STEEL



- 67442 COACH SCREW, TORX 50, 10X100 MM, STAINLESS STEEL
- 67444 BUTTON HEAD TORX 50, 10X70 MM, STAINLESS STEEL

- 39900000 WALL PLUG, 8X40 MM
- 39900001 WALL PLUG, 12X60 MM
- 39900120 WALL PLUG, 10X50 MM
- 9961004 WALL PLUG, 6X30 MM



INN-O-PLUG FOR PVC BOARD PROFILES

- 39106020 CONNECTION SCREW, TORX 30, M6X20, STAINLESS STEEL
- 39106030 CONNECTION SCREW, TORX 30, M6X30, STAINLESS STEEL
- 39106040 CONNECTION SCREW, TORX 30, M6X40, STAINLESS STEEL



- 39206037 SPLICING SLEEVE, TORX 30, M6X37, STAINLESS STEEL



- 4900466 CONNECTING SCREW SET, 39-48 MM, STAINLESS STEEL
- 4900467 CONNECTING SCREW SET, 44-58 MM, STAINLESS STEEL
- 4900468 CONNECTING SCREW SET, 49-68 MM, STAINLESS STEEL



RETAINING TOOLS

- 30878 RETAINING TOOL, FOR MOUNTING OF T-ANCHOR



- 17105 TOOL FOR BOLT-ON FITTINGS





U-BOWS

- 0211-705 U-BOLT, FOR DOWNPIPE, Ø38 X 83 X M6, A2
- 0211-707 U-BOLT, FOR DOWNPIPE, Ø43 X 88 X M6, A2
- 0211-709 U-BOLT, FOR DOWNPIPE, Ø63 X 108 X M6, A2
- 1900109 U-BOLT, 1', INCL. NUTS, GALVANIZED
- 1900199 U-BOLT, 1', INCL. NUTS, STAINLESS STEEL



FORK FITTING

- 0139-119 FORK FITTING FOR 5/4' DOWNPIPE, 1' AND 5/4' PIPE



WINDING CLAMP

- 9930019 WINDING CLAMP, 1' X 5/4'
- 9930014 WINDING CLAMP, 1' X 1'



CLAMPS

- 0221-315 CLAMP, 3/4' X Ø80 MM, COMPLETE
- 0221-196 CLAMP, 1' X Ø80 MM, COMPLETE
- 0221-214 CLAMP, 1' X Ø96 MM, COMPLETE, ELECTRO GALVANIZED
- 0221-172 CLAMP, 5/4' X Ø80 MM, COMPLETE



MASTER CLAMP

- 20035 MASTER CLAMP WATER PIPE BRACKET, 1'



- 20045 MASTER CLAMP SPACER UNIT, 1'



- 20037 MASTER CLAMP WASHER, A2, Ø10,5 MM / Ø45 MM, 1,5 MM



DRILL CLAMPS

- 93205 DRILL CLAMP, MALE THREAD, 1/2' - 1', COMPLETE



- 93164 DRILL CLAMP, 1/2' - 1', STAINLESS STEEL



- 23961195 DRILL CLAMP, 10 MM - 32/33,7 MM, PVC
- 61195 DRILL CLAMP, 8 MM - 32/33,7 MM, PVC



ACCESSORIES FOR WATER PIPES

- 20007 WATER PIPE BRACKET 2, FOR 3 MM PIPE



- 8500532 WATERPIPE HOLDER, FOR 32 MM PVC PIPES





PIPE HOLDERS

- 0234-100 PIPE HOLDER, FOR Ø75 MM PIPE
- 0221-193 PIPE HOLDER, FOR Ø80 MM PIPE
- 0221-221 PIPE HOLDER, FOR Ø96 MM PIPE
- 0146-061 PIPE HOLDER, FOR Ø90 MM PIPE
- 0146-115 PIPE HOLDER, FOR 5/4' PIPE



- 16375 PIPE RETAINER, 1', WITHOUT BOLT



HINGES - STAINLESS STEEL

- 4950463 HINGE FOR FOR Y- OR U-PROFILE, STAINLESS STEEL



- 4950465 HINGE FOR HAT PROFILE, STAINLESS STEEL



- 4950884 LOWER HINGE FOR GATE, RIGHT, STAINLESS STEEL
- 4950887 LOWER HINGE FOR GATE, LEFT, STAINLESS STEEL



HANDLES - STAINLESS STEEL

- 4910900 HANDLE, RIGHT, STAINLESS STEEL
- 4910889 HANDLE, LEFT, STAINLESS STEEL

HINGES - PLASTIC

- 8500153 LOWER HINGE FOR GATE, VERSION II



- 8500271 HINGE FOR HAT PROFILE, PVC



- 8500275 HINGE FOR FRONT PARTITION, PVC



HANDLES - PLASTIC

- 4110164 HANDLE FOR GATE, VERSION II, LEFT
- 4110163 HANDLE FOR GATE, VERSION II, RIGHT



STABILISATIONS POSTS

- 38910 STABILISATIONS POST, H58 CM
- 38909 STABILISATIONS POST, H77,4 CM
- 38916 STABILISATIONS POST, H100



- 30802 SINGLE FOOT BRACKET, FOR SLATS
- 30806 SINGLE FOOT BRACKET, FOR CONCRETE



GENERAL TERMS OF SALES AND DELIVERY

This catalogue is valid from August 2019. The catalogue is subject to the following general sales and delivery terms.

MASTER TRADING is not liable for misprints or product changes.

The sales and delivery terms stated below are valid unless a written agreement of derogation is signed between MASTER TRADING and Buyer.

DRAWINGS AND PRODUCT INFORMATION

Drawings, wording in quotes, illustrations, technical specifications and other product information etc. are guiding and subject to misprints. MASTER TRADING is not liable for any errors, misinterpretations, notices or law changes etc.

Project material (drawings, illustrations, quotes etc.) is the property of MASTER TRADING and can not be handed over to other parties without the written consent of MASTER TRADING. If these requirements are not met, MASTER TRADING reserves the right to invoice its internal costs.

QUOTATIONS

Quotations are made subject to prior sale and validity of quotes. Quotations specifically state validity. MASTER TRADING reserves the right to withdraw any quotation without prior notice.

PRICES

All prices are excluding VAT and based on all known taxes and material costs at the time of quote submission. MASTER TRADING reserves the right to price regulations due to changes in taxes or material costs.

HANDLING FEE

Orders amounting to less than 536 Euros are subject to a handling fee of 20 Euros.

DELIVERY TERMS

EXW Herning - according to Incoterms 2010. (MASTER TRADING has taken out transport insurance on all deliveries, notwithstanding delivery condition.)

TIME OF DELIVERY

Our time of delivery is according to agreement between Buyer and MASTER TRADING.

PACKING MATERIALS

Pallets and transport frames are invoiced at 11 Euros each. Pallets and frames are not returnable due to risk of infection.

RETURN OF GOODS

Return goods are only accepted according to prior and specific agreement between Buyer and MASTER TRADING. MASTER TRADING only accepts return of unused, non-damaged standard goods, which have never been installed. Return goods must be in original packing. Return goods will be credited at 80% of the item's net price.

If MASTER TRADING is project liable, all excess items after project completion are the property of MASTER TRADING.

Other terms

SELF-SUPPORTING CAST IRON

Due to production method, fluctuations in dimensions and sizes may occur. As a result, the product may be uneven. None of these fluctuations are of any significant importance to the product functionality. Cast iron slats are only intended for pigs and should not be exposed to any other strain.

GENERAL INFORMATION

Colour difference may generally occur in the products, especially products produced of miscellaneous types of PVC/plastic/fiber material.

When extra deliveries of goods or services are requested due to alleged lacks, MASTER TRADING reserves the right to invoice the goods' value as well as any other additional costs, in case a previous delivery has been made or the alleged lacks are groundless.

MASTER TRADING disclaims complaint liability if any form of acid has been added to the water or feed without prior accept from MASTER TRADING. MASTER TRADING also disclaims liability if the indoor climate does not meet the general standards of good indoor climate.

The description of goods should only be considered as guiding and is subject to errors. Therefore the component list is valid for the quotation. If the component list is not attached to the quotation, it is imposed on the Buyer to obtain it.

FIND US ONLINE

Stay connected with Master Trading via our social media pages. It's a great way to interact with us, get your questions answered and make suggestions.



<https://www.linkedin.com/company/master-trading/>

Follow Master Trading and check out the latest events

Watch videos



<https://www.youtube.com/channel/UC9oM2Y-qdDZ5vwIRic2x7Bw>



Sign up for our newsletter!
Scan the QR code or go to:
<https://www.mastertrading.dk/home/>

Visit our website, and sign up for exciting news



MASTER : TRADING



Components for modern pig production

www.mastertrading.dk



+45 9744 6677



Kirkevænget 5, 7400 Herning, Denmark