

MASTER : TRADING



COMPONENTS FOR MODERN PIG PRODUCTION



CONTACT US



Bjørn Dalsgaard Johannesen
Tel.: +45 30 66 34 37
bd@mastertrading.dk



Jan Therkildsen
Tel.: +45 2153 5668
jt@mastertrading.dk



Tino Holger Ulshöfer
Tel.: +49 4331 664 66 90
tino.ulshoefer@aco.com

MASTER TRADING
www.mastertrading.dk



▲ Scan the QR code
and see our contacts



▲ Scan the QR code and watch the
presentation of Master Trading
by Jan Therkildsen, Area Sales Manager

MASTER TRADING



COMPONENTS FOR MODERN PIG PRODUCTION

MASTER TRADING is a specialist in various components for pig production. Our product program covers all products necessary for a well functioning and efficient pig barn - from bolts and screws to the intelligent feeding systems.

We aim to deliver the best solutions with focus on animal welfare, usability in the barn, optimal logistics and competitive prices. Our products' design is tested throughout the years and approved by many farmers worldwide.

YOU ARE WELCOME TO VISIT US

MASTER TRADING's office is located in Herning, Denmark. Here, you can visit our SHOWROOM and see our wide range of products.

Without any commitment you can see, feel and try out the differences and functions and thereby choose the solution that matches exactly your needs. You can, of course, also get professional guidance from our experienced sales consultants.



INDEX

2	CONTACT US	38	DRINKERS
3	MASTER TRADING	40	Drinkers
6	FEEDERS	42	MASTER FLOW
8	TUBE-O-MAT®	43	Tilttable trough
9	TUBE-O-MAT® VI+	44	Drinking valves
10	TUBE-O-MAT® CLASSIC	48	FARROWING
13	Accessories for TUBE-O-MAT®	50	Farrowing pens
15	TURBOMAX feeder	51	INN-O-CRATE & Funki farrowing pens
16	FUNKIMAT® feeder	52	Accessories for farrowing pens
19	Accessories for FUNKIMAT®	53	Sow troughs for farrowing pens
20	Feed outlets & Downpipes	54	INN-O-CORNER® Piglet nest
22	Downpipes and Feed bowls	56	Heating lamps
24	BABY FEEDER®	58	Master Heater
26	BOX Feeder	59	UniComfort
29	AD-LIB Feeder	60	BABY CARE Milk system
30	Feed dispensers	62	MATING ACCESORIES
33	Compact Feeder	64	Boar door
34	MASTER VALVE SOW	65	Stimulus
35	MASTER VALVE DRY	66	LED-light
36	OPTISCALE	67	INN-O-LED & accessories



68	FLOORING	100	DRY FEEDING SYSTEM
70	COMBI-FLOOR		
71	Plastic and cast iron slats for COMBI-FLOOR	106	SILO AND SUPPORT
72	Cast iron slats and supports for COMBI-FLOOR	108	Overview of steel silo
73	Accessories for COMBI-FLOOR	110	Support system
76	Heating plates & accessories		
77	First care	111	WASHING ROBOT
78	Self-supporting cast iron slats		
80	BOARD PROFILES	112	HERDING BOARDS
82	PVC Board profiles		
84	Accessories & fiber board profiles	113	ROOTING MATERIALS
86	Climate covers		
88	FLEXCOVER Climate cover	114	FASTENERS
91	Accessories for FLEXCOVER®		
92	TROUGHS	123	FIND US ONLINE
94	Stainless steel troughs		
98	Polymer concrete products		

FEEDERS

Optimal feed solutions for weaners and finishers based on MASTER TRADING many years of experience with feeders.

We offer feeders for all age groups - easy to mount and easy to use. The feeders are designed for easy filling and to ensure optimal utilization of the volume.





TUBE-O-MAT®

VI+ & CLASSIC

The optimum user-friendly feeder

VOLUME

Hopper 83 L / approx. 58 kg
Hopper Jumbo 160 L / approx. 112 kg

CAPACITY PER TROUGH

Wean-to-Finish 7-120 kg: 30-50 pigs
Finishers 18-120 kg: 30-50 pigs
Jumbo: 50-70 pigs

TROUGH

1 mm stainless steel

FRAME

3 mm stainless steel

WATER SUPPLY

3/8" stainless steel pipe, external thread
Adjustable press nipple, stainless steel, item no. 93245

The optimum feeder

- Complete program for weaners, WEAN-TO-FINISH and finishers
- Lid with three feed inlets ensures a correct filling
- The arched, dust-repellent shape of the lid ensures a maximum space utilization
- Transparent shielding and lid ensure better overview and easy hygiene control
- The opening part of the lid is placed in a low height in order to make manual filling and inspection easy
- Vertical sides to prevent bridging
- Water supply via flexible PE-hoses ensures a constant supply of water and easy mounting

TUBE-O-MAT VI+

- 89550* TUBE-O-MAT VI+, WEAN-TO-FINISH



TUBE-O-MAT JUMBO

- 89650* TUBE-O-MAT VI+JUMBO, WEAN-TO-FINISH



* Can be delivered assembled (item no.+M) or unassembled (item no.+U).



TUBE-O-MAT CLASSIC

- 89585* TUBE-O-MAT CLASSIC, WEAN-TO-FINISH
- 89587* TUBE-O-MAT CLASSIC, FINISHER



TUBE-O-MAT CLASSIC JUMBO

- 89685* TUBE-O-MAT CLASSIC JUMBO, WEAN-TO-FINISH

* Can be delivered assembled (item no.+M) or unassembled (item no.+U).

TUBE-O-MAT VI+ (WITH WEAN-TO-FINISH TROUGH) - 89550

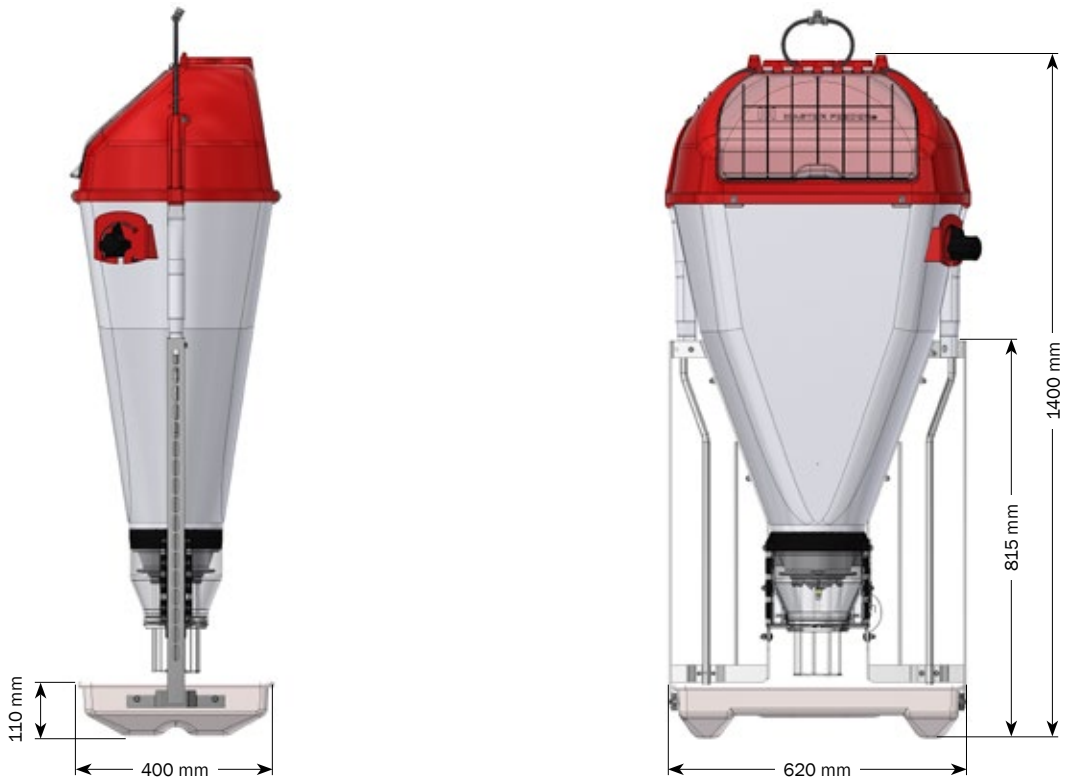

TUBE-O-MAT VI+ JUMBO (WITH FINISHER TROUGH) - 89660

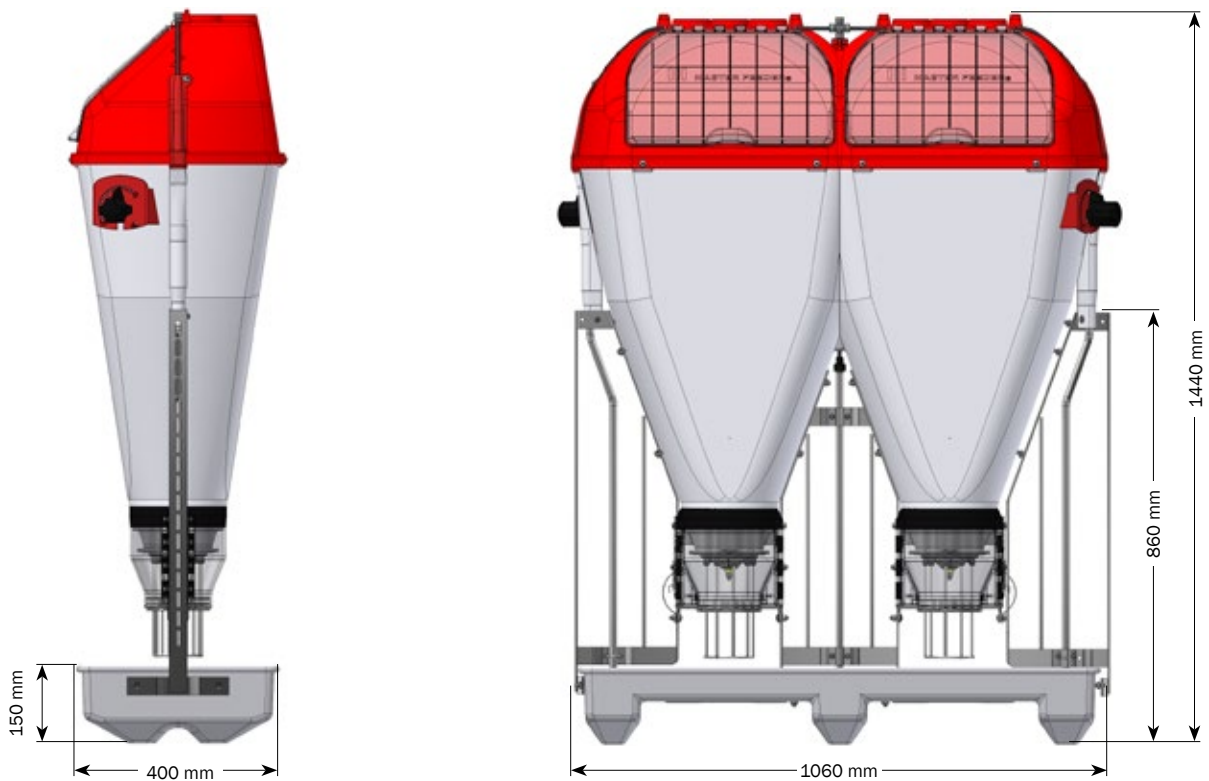

TUBE-O-MAT CLASSIC (WITH FINISHER TROUGH) - 89587

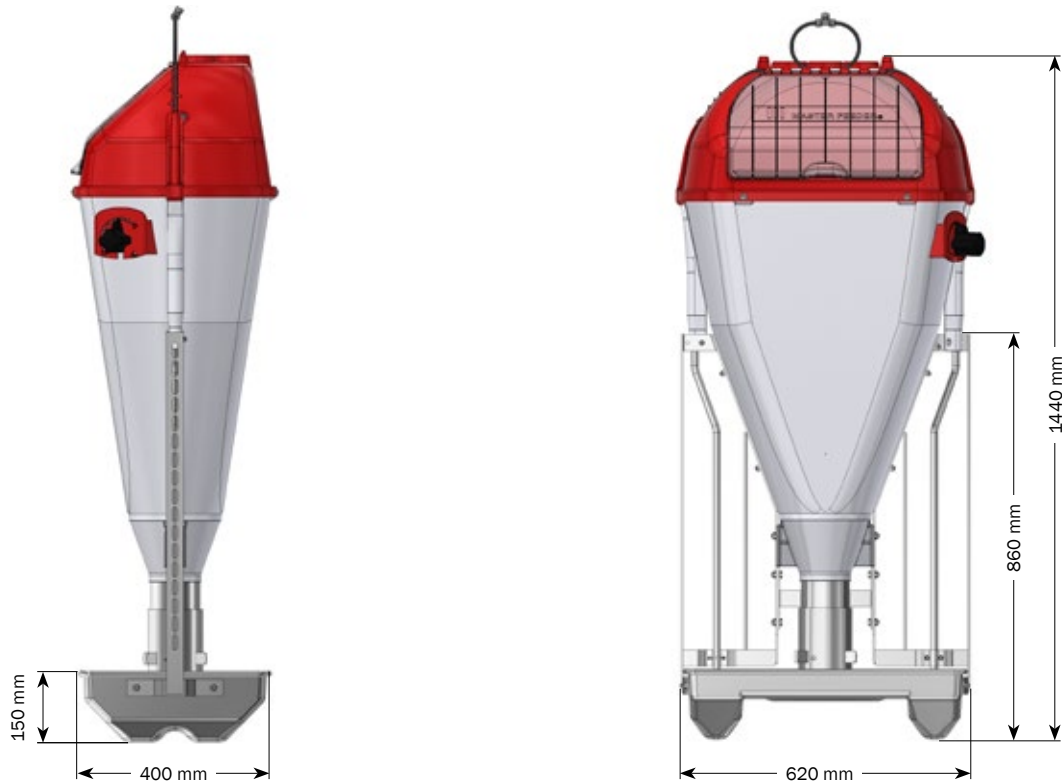

TUBE-O-MAT CLASSIC JUMBO (WITH WEAN-TO-FINISH TROUGH) - 89685

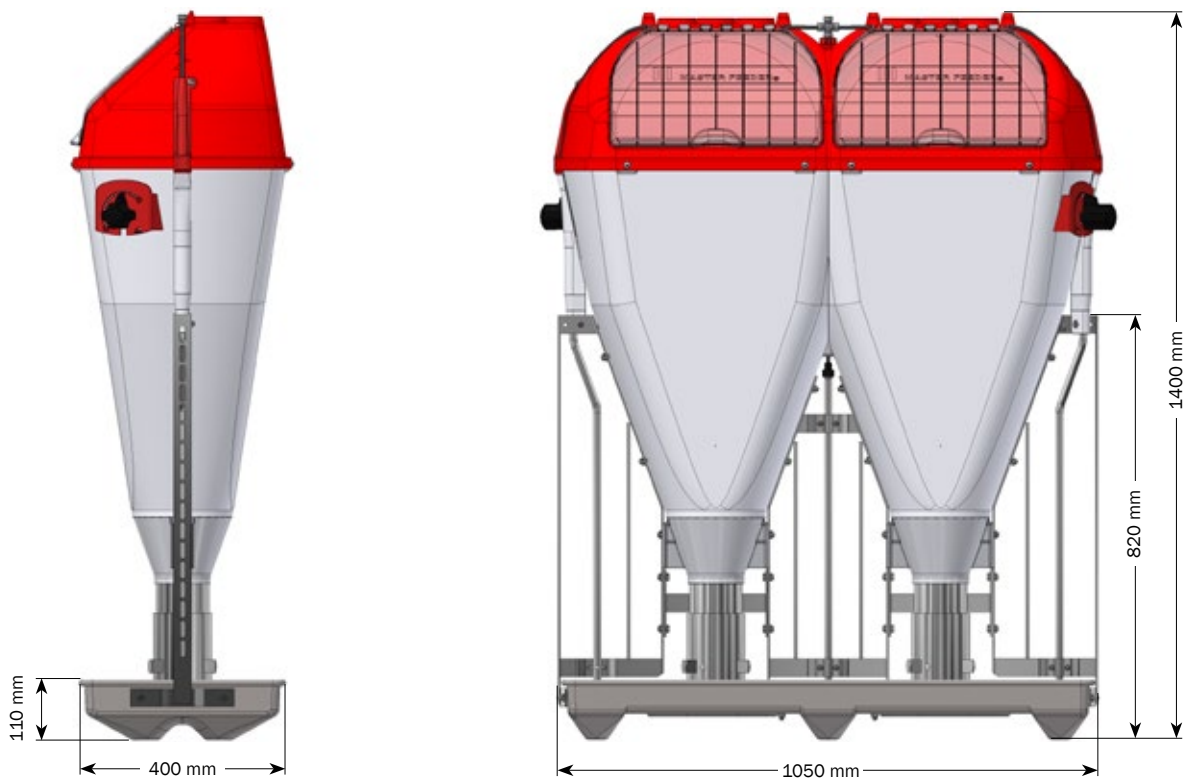

ACCESSORIES FOR TUBE-O-MAT VI+ & CLASSIC

- 38524 MOUNTING KIT FOR U-POST, AGAINST FEEDERS



ACCESSORIES FOR TUBE-O-MAT VI+

- 76262 FEED OUTLET SET, FOR TUBE-O-MAT VI+



- 72391 SPIRAL, FOR TUBE-O-MAT VI+



- 72235 ADJUSTMENT BAR, FOR TUBE-O-MAT VI+, LENGTH 680 MM



For reconstruction of TUBE-O-MAT VI+ use 76262 + 72235

ACCESSORIES FOR TUBE-O-MAT CLASSIC

- 76275 FEED OUTLET SET, FOR TUBE-O-MAT CLASSIC



ACCESSORIES FOR TUBE-O-MAT CLASSIC

- 72395 SPIRAL, FOR TUBE-O-MAT CLASSIC



- 72209 ADJUSTMENT BAR, FOR TUBE-O-MAT LTD CLASSIC, LENGTH 775 MM



For reconstruction of TUBE-O-MAT CLASSIC use 76275 + 72209

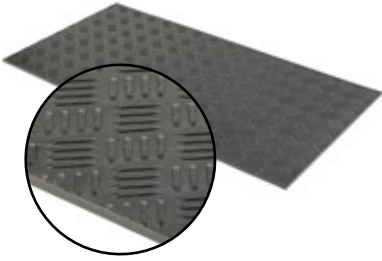

FLOOR PLATES FOR TUBE-O-MAT

- 89014 FLOOR PLATE FOR SINGLE TUBE-O-MAT 10X608X1200 MM
- 89016 FLOOR PLATE FOR DOUBLE TUBE-O-MAT 10X1040X1200 MM



ACCESSORIES FOR TUBE-O-MAT

- 74501 FOOT BRACKET H: 16 CM, W: 18 CM, FINISHER
- 74502 FOOT BRACKET H: 12 CM, W: 18 CM, WEAN-TO-FINISH
- 74503 FOOT BRACKET H: 16 CM, W: 25 CM, FINISHER
- 74504 FOOT BRACKET H: 12 CM, W: 25 CM, WEAN-TO-FINISH



- 0170-201 SINGLE TROUGH TUBE-O-MAT V+ AND CLASSIC WEAN-TO-FINISH, 11X40X60 CM



- 0170-202 DOUBLE TROUGH TUBE-O-MAT V+ AND CLASSIC, 11X40X103 CM



TURBOMAX

Fresh water and dry feed for pigs 7-120 kg

VOLUME

Hopper	100 L / approx. 70 kg
Hopper Jumbo	190 L / approx. 130 kg

TROUGH

1 mm stainless steel

FRAME

Plastic

CAPACITY PER TROUGH

Weaners up to 30 kg:	30-50 pigs
Wean-to-Finish 7-120 kg:	30-50 pigs
Finishers 18-120 kg:	30-50 pigs
Jumbo:	50-70 pigs

WATER SUPPLY

3/8" stainless steel pipe with external thread
Stainless steel press valve item no. 93245

The original feeder

- The design prevents bridging
- The hopper has a large filling hole and a low filling height
- The lid can be closed tight, and the adjustable feed supply ensures fresh feed
- The design ensures top hygiene and easy cleaning

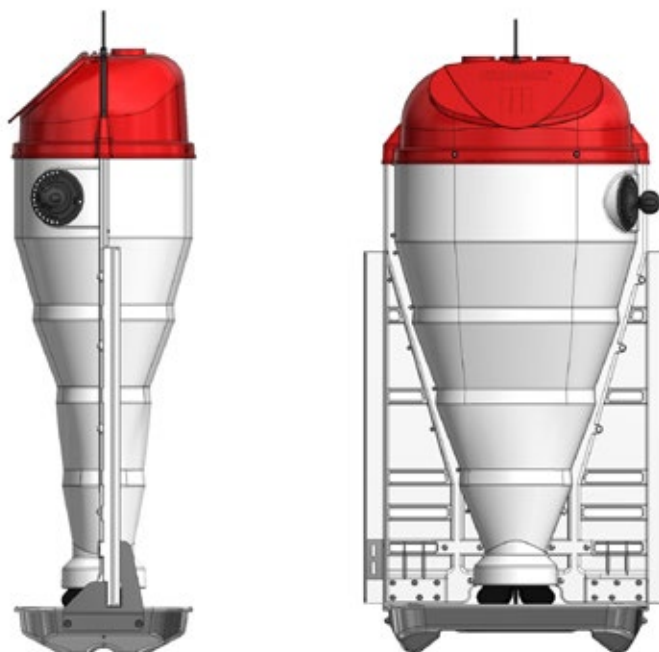

- 560180* TURBOMAX FEEDER 7-30 KG
- 560185* TURBOMAX FEEDER 30-120 KG
- 0228-276 STAINLESS STEEL POST FOR FEEDER

* Can be delivered assembled (item no. +M) or unassembled (item no. +U).



FUNKIMAT®

FEEDERS



Easy adjustable feeder for weaners and finishers, 6 - 120 kg

VOLUME

FUNKIMAT	100 L
DOUBLE	200 L

TROUGH

1 mm stainless steel

FRAME

3 mm stainless steel

CAPACITY PER FEEDER

FUNKIMAT	50 pigs (6-120 kg)
DOUBLE	80 weaners / 70 finishers

- Available for weaners and finishers
- Optimum well-being for pigs
- High daily weight gain
- Is ideal for both ground feed and pellets
- Water and feed separated
- No bridging
- Large adjustment handle allows easy and fast regulation of feeding
- Exact feed dosage ensures continuously fresh feed

FUNKIMAT SINGLE - WITH STAINLESS STEEL TROUGH

- 560710* FUNKIMAT, FOR WEANER, WITH STAINLESS STEEL TROUGH (FLAT-FLAT)
- 560711* FUNKIMAT, FOR FINISHER, WITH STAINLESS STEEL TROUGH (FLAT-FLAT)



* Can be delivered assembled (item no.+M) or unassembled (item no.+U).

FUNKIMAT DOUBLE

- 0227-670 DOUBLE FUNKIMAT, (FLAT-FLAT) - UNASSEMBLED
- 0227-714 STAINLESS STEEL TROUGH FOR DOUBLE FUNKIMAT, WEANER
- 0227-715 STAINLESS STEEL TROUGH FOR DOUBLE FUNKIMAT, FINISHER



FUNKIMAT SINGLE (FOR WEANERS) - 560710

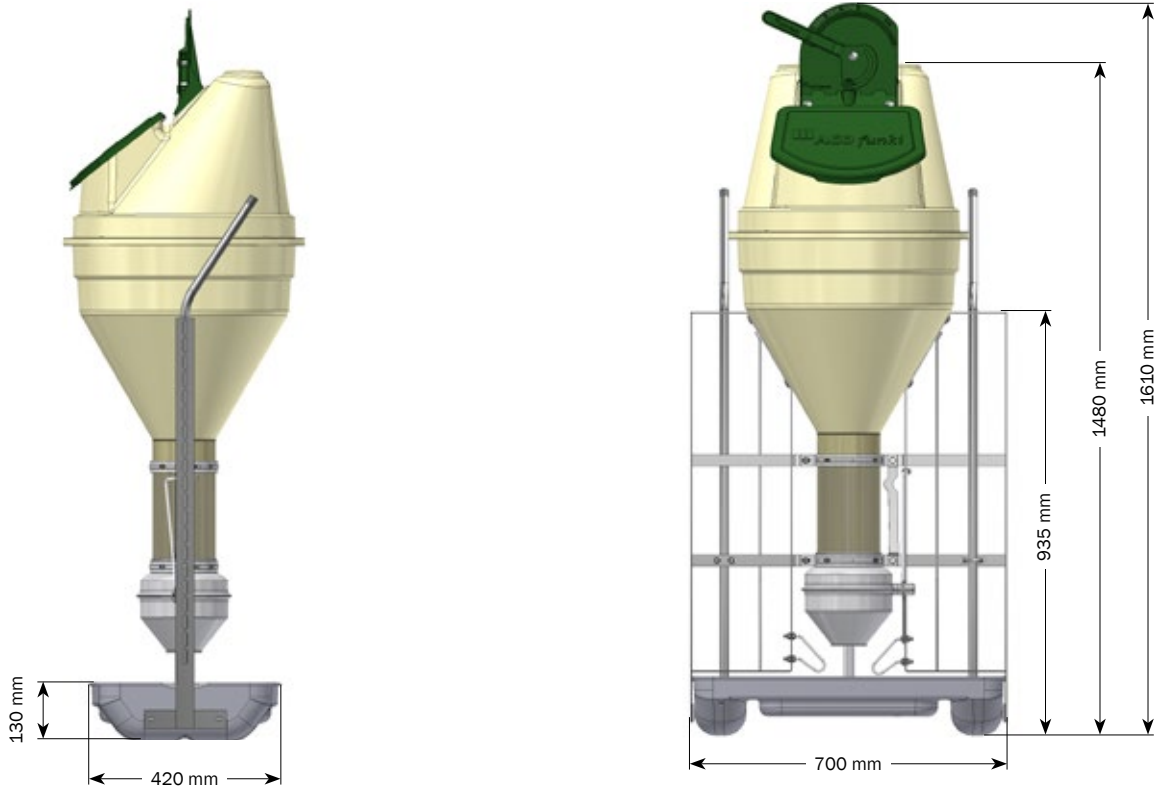

FUNKIMAT DOUBLE (FOR FINISHERS) - 0227-970

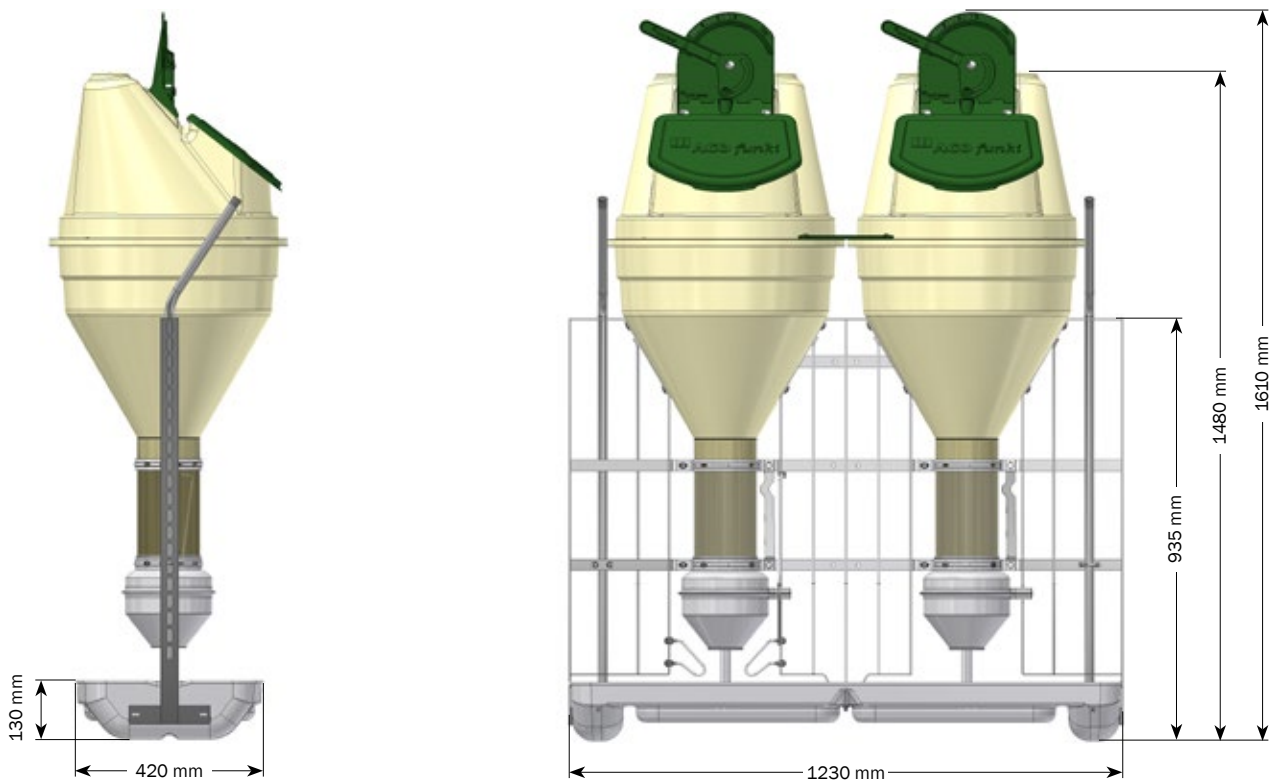

- 0227-088 DOSAGE DISC VER. 3, Ø174 MM
- 0227-309 DOSAGE DISC VER. 4, SMALL Ø 164 MM



- 38524 MOUNTING KIT FOR U-POST AGAINST FEEDERS



- 0227-150 TROUGH FOOT FOR FEEDER, ADJUSTABLE, STAINLESS STEEL



- 0227-700 PRESSED TROUGH FOR SINGLE FUNKIMAT, WEANER, STAINLESS STEEL
- 0227-701 PRESSED TROUGH FOR SINGLE FUNKIMAT, FINISHER, STAINLESS STEEL



- 0227-704 PRESSED TROUGH FOR DOUBLE FUNKIMAT, WEANER, STAINLESS STEEL
- 0227-705 PRESSED TROUGH FOR DOUBLE FUNKIMAT, FINISHER, STAINLESS STEEL
- 0227-558 FLOOR PLATE FOR DOUBLE FUNKIMAT AND 3N1 ROTO 10X1200X1200 MM
- 0227-559 FLOOR PLATE FOR SINGLE FUNKIMAT AND 3IN1 ROTO 10X670X1200 MM



FEED OUTLETS & DOWNPIPES

Efficient and hygienic feed outlets for feeders

OUTLET SIZES

38 / 60 mm and
38 / 50 / 60 / 76 mm

- Feed outlet with a number of unique functional advantages
- Quick and efficient draining of feed
- Great hygiene
- Large capacity
- Always dry feed. Designed to keep water and moisture out
- Reliable slide that fits tightly to the feed pipe and prevents feed from accumulating

T-PIECES

- 90486 FIXED T-PIECE, FOR 60 MM
- 0228-488 FIXED T-PIECE, FOR 76 MM
- 0232-010 T-PIECE WITH SLIDE, Ø60



TELESCOPE PIPES

- 0228-595 TELESCOPE PIPE, Ø67,5 MM
- 0228-480 TELESCOPE PIPE, Ø80 MM



DOWNPIPES

- 0228-588 DOWNPIPE, Ø63X2X1000 MM, WITH HOLE
- 90249 DOWNPIPE, Ø75X1000 MM



- 0228-510 Y-PIECE 75 MM 60°



- 90208 BEND 45° 75 MM MALE/NIPPEL



- 90210 Y-BRANCH, Ø75 MM, 90°



DOWNPIPES AND FEED BOWLS



- 90211 Y-BRANCH, Ø63 MM, 60°



- 90212 Y-BRANCH, Ø63 MM, 30°



- 0228-500 Y-BRANCH, Ø75-63-63 MM, WITH LOCK, 60°

FEED BOWLS - PLASTIC



- 90012 MINI FEED BOWL PLASTIC WITH BRACKET



- 96061 PAN FOR PIGLETS, Ø26 CM
- 96063 PAN FOR PIGLETS, Ø39 CM

FEED BOWL - STEEL



- 560395 BOWL WITH FIXING HOOK, Ø24 CM, 2,5 L, STAINLESS STEEL

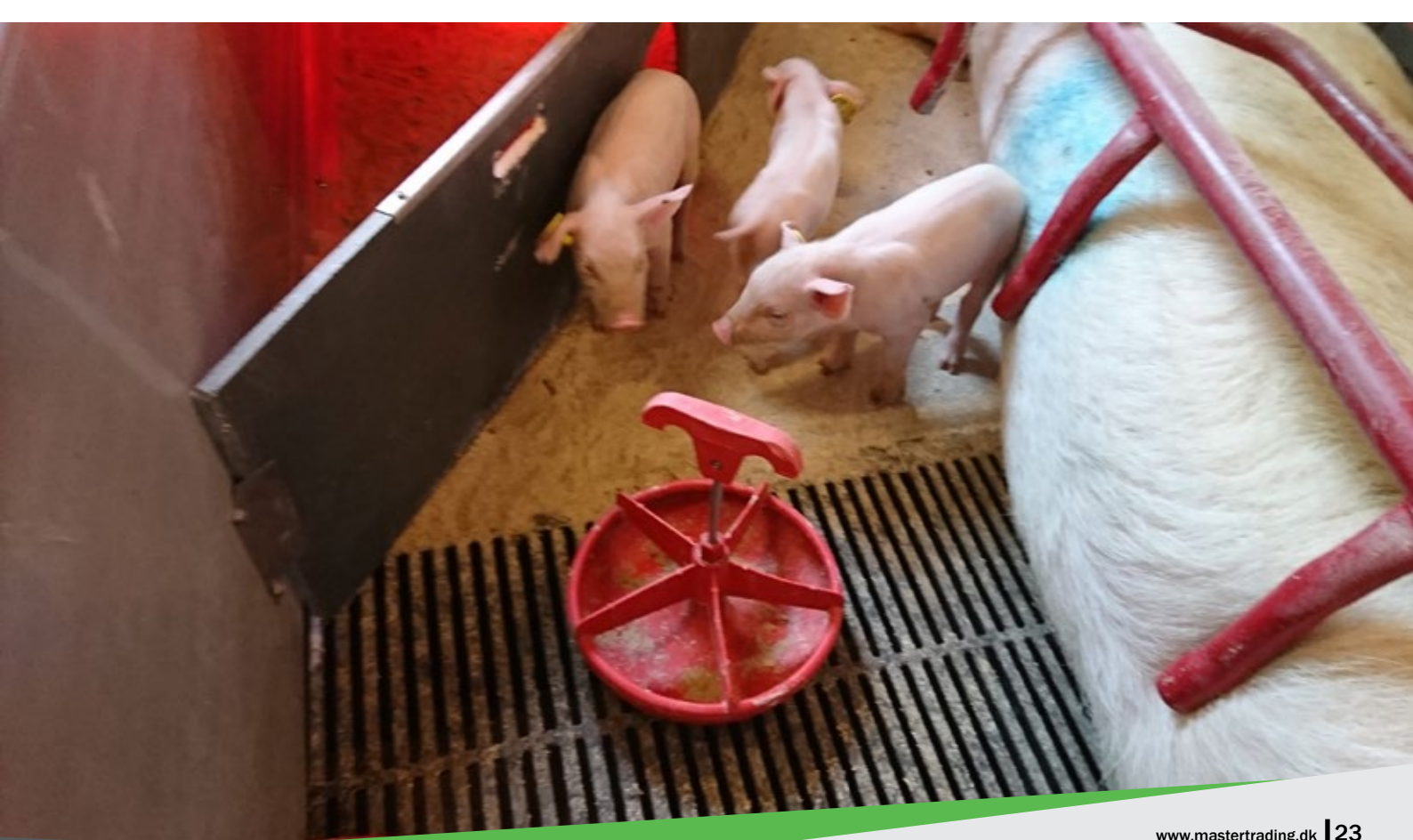



BABY FEEDER®



Mix of feed and water - for pigs from 4 kg

WATER

Connection Provided with 3 m hose of 8 mm
Pressure 2,5 bar (recommended)

ENERGY

Energy plug SCHUKO plug as standard
Cable 4,5 m
Connection No electrician needed

FEED

Feed types Pellets and ground feed

TROUGH

1 mm stainless steel

FRAME

3 mm stainless steel

- The best start for pigs after weaning
- Increases feed and water intake
- Ensures optimal growth
- Fills the trough when the sensor indicates it is empty
- Always fresh feed and water
- Easy to clean
- Reliable and easy to operate
- Adjustable pause time from emptying to feed assignment
- Possible to adjust water volume
- Up to 60 pigs per feeder

BABY FEEDER

■ 0229-000 BABY FEEDER



BABY FEEDER (WITH WEAN-TO-FINISH TROUGH) - 0229-000

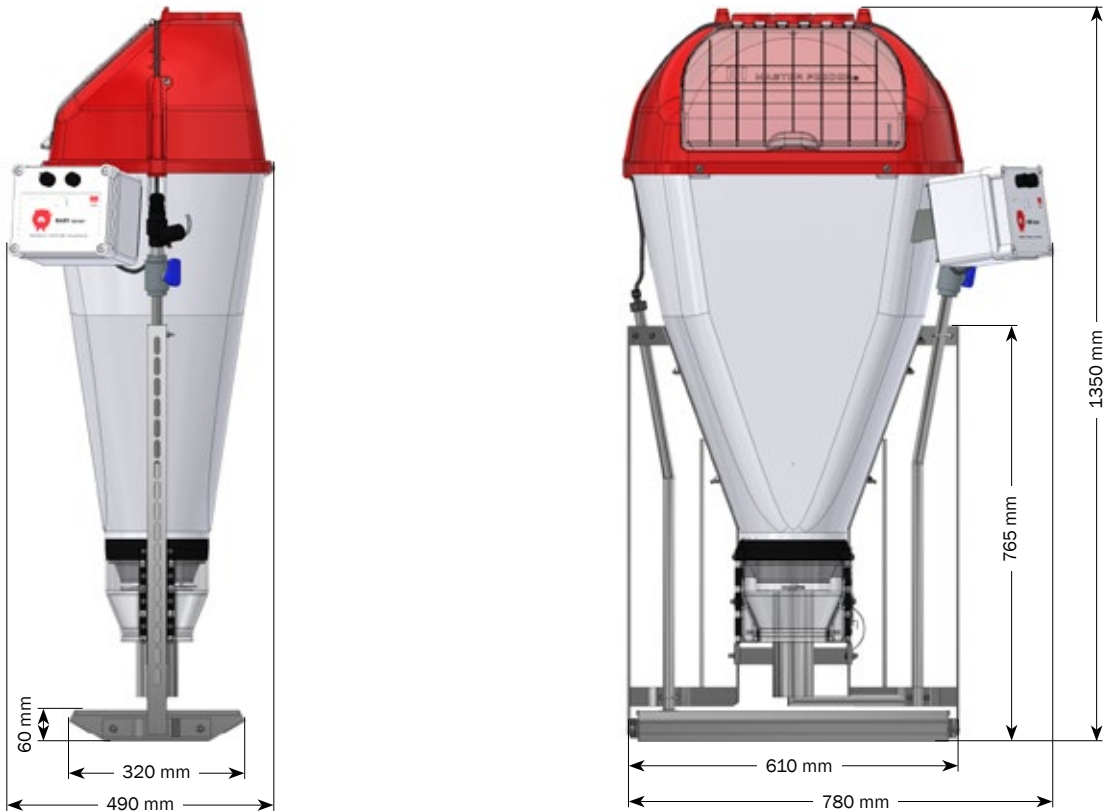



BOX FEEDER

MATERIALS

304 stainless steel

THICKNESS

1,2mm

TYPES

For weaners and finishers

- Easy access to feed
- No sharp edges
- Easy to clean
- Minimum feed waste
- All made in stainless steel
- Accurate multi-level adjustment
- Highly resistant against wear and tear = long lifespan
- Excellent value for money

Can be delivered assembled (item no.+M) or unassembled (item no.+U).

BOX FEEDER WEANERS - STAINLESS STEEL, WxHxD

SINGLE

- 560355 BOX FEEDERS WEANERS 1X4 80X29X70 CM
- 560356 BOX FEEDERS WEANERS 1X6 120X29X70 CM
- 560357 BOX FEEDERS WEANERS 1X8 160X29X70 CM
- 560358 DOWNPIPE SUPPORT SINGLE WEANER FEEDER
- 560359 1" SS PIPE INCL. U-CLAMP AND NUTS, SINGLE WEANER FEEDER

DOUBLE

- 560360 BOX FEEDERS WEANERS 2X4 80X47X70 CM
- 560361 BOX FEEDERS WEANERS 2X6 120X47X70 CM
- 560362 BOX FEEDERS WEANERS 2X8 160X47X70 CM
- 560363 DOWNPIPE SUPPORT DOUBLE WEANER FEEDER
- 560364 1" SS PIPE INCL. U-CLAMP AND NUTS, DOUBLE WEANER FEEDER

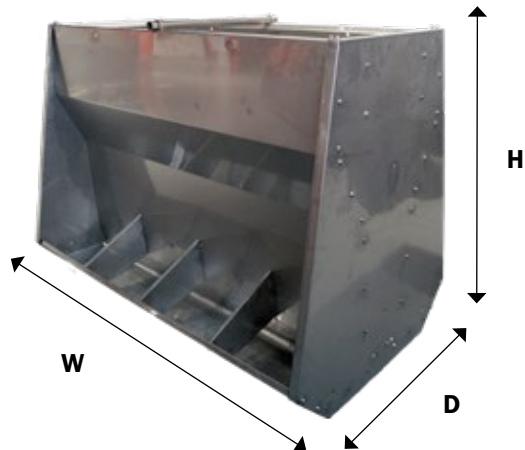

BOX FEEDER WEAN-TO-FINISH - STAINLESS STEEL, WxHxD

SINGLE

- 560365 BOX FEEDERS WEAN-TO-FINISH 1X3 90X40,8X90 CM
- 560366 BOX FEEDERS WEAN-TO-FINISH 1X4 120X40,8X90 CM
- 560367 BOX FEEDERS WEAN-TO-FINISH 1X5 150X40,8X90 CM
- 560368 DOWNPIPE SUPPORT SINGLE WEAN-TO-FINISH FEEDER
- 560369 1" SS PIPE INCL. U-CLAMP AND NUTS SINGLE WEAN-TO-FINISH FEEDER

DOUBLE

- 560370 BOX FEEDERS WEAN-TO-FINISH 2X3 90X73,5X90 CM
- 560371 BOX FEEDERS WEAN-TO-FINISH 2X4 120X73,5X90 CM
- 560372 BOX FEEDERS WEAN-TO-FINISH 2X5 150X73,5X90 CM
- 560373 DOWNPIPE SUPPORT DOUBLE WEAN-TO-FINISH FEEDER
- 560374 1" SS PIPE INCL. U-CLAMP AND NUTS DOUBLE WEAN-TO-FINISH FEEDER

INSERTS

- 560381 WEAN-TO-FINISH INSERT 2X2
- 560383 WEAN-TO-FINISH INSERT 2X3
- 560385 WEAN-TO-FINISH INSERT 2X4
- 560387 WEAN-TO-FINISH INSERT 2X5

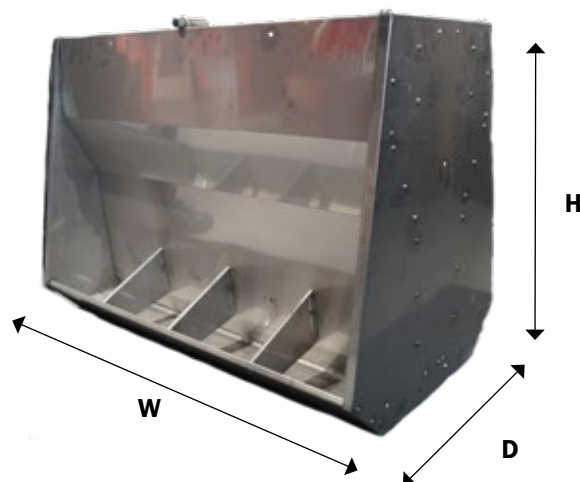

BOX FEEDER

WET/DRY BOX FEEDER - STAINLESS STEEL, WxHxD

SINGLE

- 560375 WET/DRY BOX FEEDERS WEANERS 2X4 98X39,5X70 CM
- 560376 WET/DRY BOX FEEDERS WEANERS 2X5 122,5X39,5X70 CM
- 560377 WET/DRY BOX FEEDERS WEANERS 2X6 147X39,5X70 CM
- 560378 DOWNPIPE SUPPORT WET/DRY WEANER FEEDER
- 560379 1" SS PIPE INCL. U-CLAMP AND NUTS WET/DRY WEANER FEEDER

DOUBLE

- 560380 WET/DRY BOX FEEDERS FINISHER 2X2 76X51,5X90 CM
- 560382 WET/DRY BOX FEEDERS FINISHER 2X3 114X51,5X90 CM
- 560384 WET/DRY BOX FEEDERS FINISHER 2X4 152X51,5X90 CM
- 560386 WET/DRY BOX FEEDERS FINISHER 2X5 190X51,5X90 CM
- 560388 DOWNPIPE SUPPORT WET/DRY FINISHER, WEAN-TO-FINISH FEEDER
- 560389 1" SS PIPE INCL. U-CLAMP AND NUTS WET/DRY WEAN-TO-FINISH FEEDER

WATER

- 560390 WATER PIPE FOR BOX FEEDER WITH WATER
- 8450239 BRACKET FOR BOX FEEDER WITH WATER

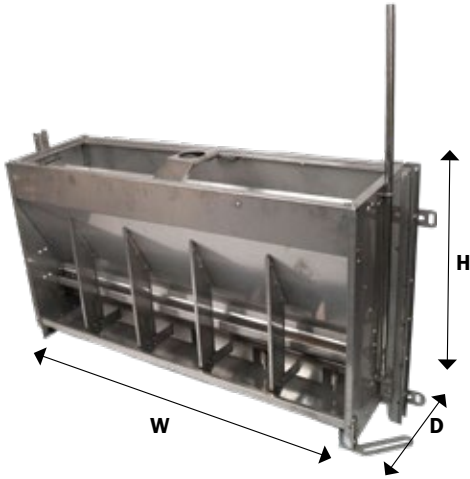

AD-LIB FEEDER

More piglets per litter



- **Ad libitum feeding for lactating sows**
The feeder helps to get higher milk yield, to improve feed and water intake, to increase litter weaning weight and to improve sow reproduction in general.
 - **Less weight loss for sows**
With the AD-LIB Feeder, the sow can mix feed and water with no clogging. It is just one of many benefits of ad libitum feeding of sows in farrowing crates.
 - Lower piglets mortality
 - The feeder can be regulated in three different positions
- 560037 AD-LIB FEEDER, volume 7L

FEED DISPENSERS

Reliable feed distribution and accurate dosage

VOLUME

6 L / 8 L / 10 L

FITS FEED TUBES

VD2 Ø38 / Ø50 / Ø60 / Ø70 MM
 VD5 Ø38 / Ø50 / Ø60 / Ø70 MM / Ø76 MM
 VD6 Ø38 / Ø50 / Ø60 / Ø70 MM
 VD22 Ø38 / Ø50 / Ø60 / Ø70 MM

DISPENSER TYPES

Ball / Flap

- **Reliable feed distribution even by small amounts**
Strong bottom, the feed does not shift out inadvertently. At the same time, the dispenser is emptied at every feeding - no feed remains in the hopper
- **Accurate dosage**
No feed dosing pipe in the feed dispenser. The scale shows the exact amount being distributed
- **Easy adjustment**
The amount of feed is easily adjusted by using the handle on the side of the feed dispenser. The handle can be operated from the feed corridor
- **Extra durable**
Minimum wear because of the simple construction

VD100 FEED DISPENSER

- 0223-240* VD100 FLOOR FEEDER



* Can be delivered assembled (item no.+M) or unassembled (item no.+U).

VD2 FEED DISPENSERS

- 0221-252 VD2 - Ø60, 6 L, WITH FLAP, Ø75 MM OUTLET
- 0221-253 VD2 - Ø60, 8 L, WITH FLAP, Ø75 MM OUTLET
- 0221-254 VD2 - Ø60, 10 L, WITH FLAP, Ø75 MM OUTLET



- 0221-138 BOTTOM, WITH CLOSING FLAP AND ARM, FOR VD1+VD2



- 0221-127 SLIDE, WITHOUT HOLE



VD6 FEED DISPENSERS

- 0222-660 VD6 - Ø60, 6 L, WITH FLAP, Ø75 MM OUTLET
- 0222-668 VD6 - Ø60, 8 L, WITH FLAP, Ø75 MM OUTLET



ACCESSORIES FOR VD2 AND VD6

- 0131-191 CONNECTION FOR VD2 Ø60 / Ø38
- 0221-400 CONNECTION FOR VD2 Ø60 / Ø50
- 0221-401 CONNECTION FOR VD2 Ø60 / Ø55





VD5 FEED DISPENSERS

- 0221-985 VD5 - Ø38 MM, 7 L, WITH BALL, Ø75 MM OUTLET
- 0221-984 VD5 - Ø50 MM, 7 L, WITH BALL, Ø75 MM OUTLET
- 0221-983 VD5 - Ø55 MM, 7 L, WITH BALL, Ø75 MM OUTLET
- 0221-982 VD5 - Ø60 MM, 7 L, WITH BALL, Ø75 MM OUTLET
- 0221-981 VD5 - Ø75 MM, 7 L, WITH BALL, Ø75 MM OUTLET



ACCESSORIES FOR VD5

- 0221-980 BOTTOM FOR VD5 VOLUME DISPENSER, DECENTRALIZED OUTLET



- 0221-939 BOTTOM FOR VOLUME DISPENSER VD5, CENTRALIZED OUTLET



VD22 FEED DISPENSERS

- 0221-506 VD22 - Ø60, 6 L, WITHOUT OUTLET
- 0221-508 VD22 - Ø60, 8 L, WITHOUT OUTLET
- 0221-510 VD22 - Ø60, 10 L, WITHOUT OUTLET



ACCESSORIES FOR VD22

- 0221-512 VD2 BOTTOM HOPPER, FOR Ø75 MM OUTLET
- 0221-515 VD5 BOTTOM HOPPER, FOR DECENTRALIZED Ø75 MM OUTLET
- 0221-516 VD5 BOTTOM HOPPER, FOR Ø75 MM OUTLET
- 91810 HOPPER WITH INSERT 75 MM FEED PIPE



COMPACT FEEDER

Precision feeding



- Better conditions for sow**
 The feeder makes sure there is minimal loss of the sow's body condition, while always feeding fresh and palatable feed.
- Easy mounting and better work environment**
 The feeder can easily be added to any conventional dry-feed system and saves worktime do to no need for cleaning troughs. it also make individual feeding strategy throughout day and night (real-time).
- Hopper for vitamins and medicine**
 The extra wide hopper makes it easy to add medication and vitamins to the feed, if necessary.

MASTER VALVE SOW

Feed dispenser with integrated pneumatic valve - perfect for phase feeding of sows

VOLUME

6 L

PIPE SIZE

60 mm valve / Ø75 mm outlet

- Perfect for phase feeding of sows in the farrowing and gestation units
- Save feed costs
- Optimal use of feeding system
- User-friendly control unit
- Simple and reliable
- Lock for feed release, if the sow has not eaten up
- Easy to adjust the feed amount
- Can be adjusted while the feed dispenser is full

MASTER VALVE SOW

- 0222-655 MASTER VALVE SOW - COMPLETE





MASTER VALVE DRY

Pneumatic valve for dry feed with Y-outlet

- Special Y-outlet for simultaneous use with several dry feeding units
- Operates with a pneumatic cylinder with air pressure
- Individually controlled feeding
- Easy lock
- Easy cleaning of pipes

PIPE SIZE

Ø60 mm valve / Ø75 mm outlet



MASTER VALVE DRY

- 0228-550 DRY FEED VALVE - COMPLETE

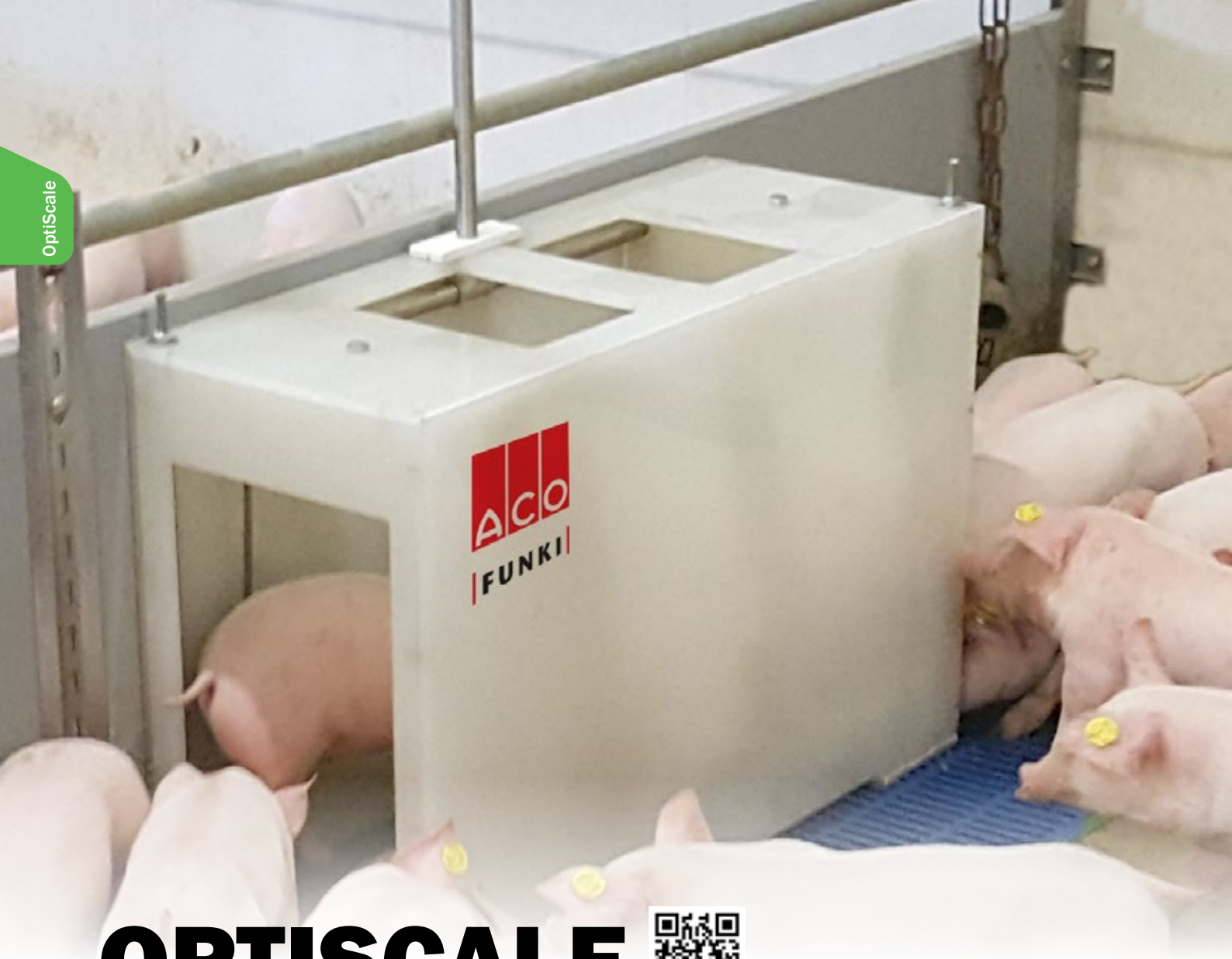

OPTISCALE



Accurate monitoring of pigs growth

- Weighs 24/7
- Helps to optimize the genetic potential
- Pigs growth curves day by day
- Easy installation
- Connects directly to MultiController
- Can be placed in one pen or between two pens
- OptiScale is available in two models - one for weaners and a larger model for finishers.



OPTISCALE FOR WEANERS

- 0228-512 MULTICONTROLLER OPTISCALE WEANER

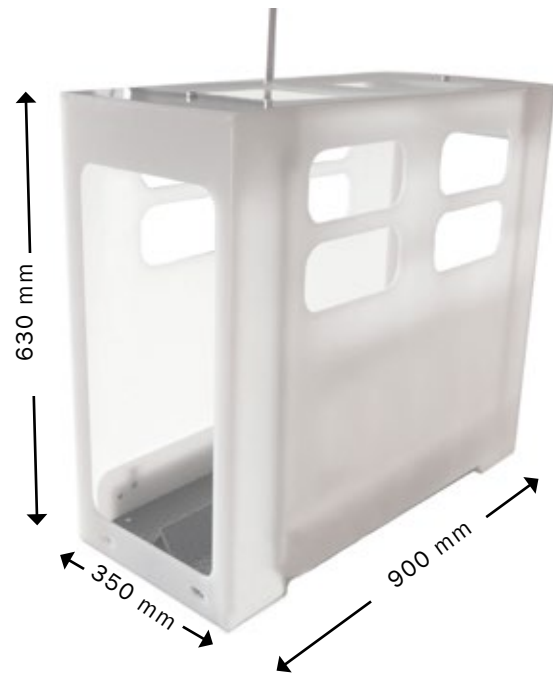

OPTISCALE FOR FINISHERS

- 0228-513 MULTICONTROLLER OPTISCALE FINISHER

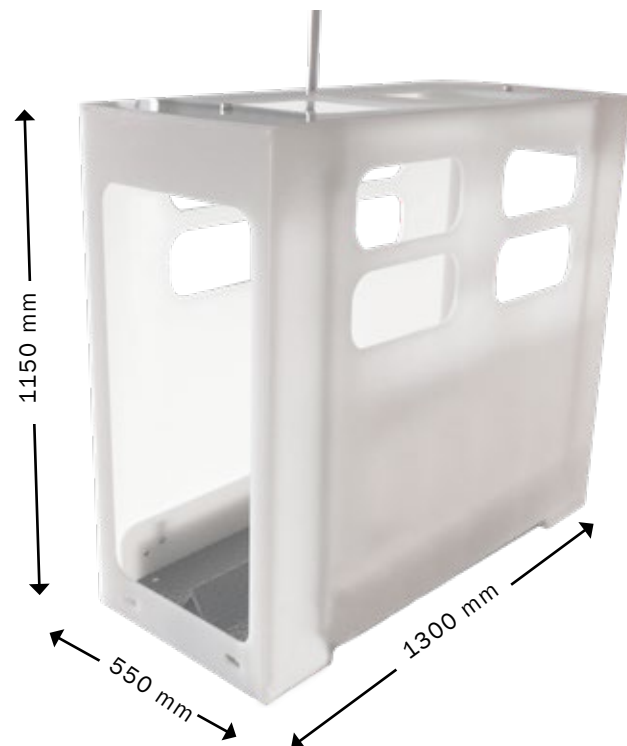

DRINKERS

*MASTER TRADING provides you with the best drinkers.
Our range consists of top-hygienic drinkers for weaners, sows and finishers - as well as drinkers specially developed for piglets.*





DRINKERS

Hygienic drinkers for all types of pigs

DRIK-O-MAT and NN DRINKING CUPS

- Rounded, hygienic design
- For all pig types
- Stainless steel

VIP-O-MAT - for piglets

- Top hygiene and tiltable bottom plate
- Connects to sow water or separate water supply
- Stainless steel and plastic

STAINLESS STEEL DRINKING CUP - for piglets

- Top hygiene
- Connects to sow water
- Height adjustable drinking valve

PIGLET DRINKER

- Top hygiene and tiltable bottom plate
- Connects to sow water or separate water supply
- Stainless steel and plastic

Recommended water pressure: 2,5 Bar

VIP-O-MAT®

- 93520 VIP-O-MAT, INCL. HOSE PROTECTOR



NN DRINKING CUPS

- 560120 NN DRINKING CUP MINI, ASSEMBLED
- 560130 NN DRINKING CUP STANDARD, ASSEMBLED
- 560140 NN DRINKING CUP MULTI, ASSEMBLED
- 560160 NN DRINKING CUP MAXI, ASSEMBLED



MINI

STANDARD

MULTI

MAXI

DRIK-O-MAT®

- 93570 DRIK-O-MAT MINI
- 93575 DRIK-O-MAT STANDARD
- 93600 DRIK-O-MAT MULTI
- 93500 DRIK-O-MAT MAXI



MINI

STANDARD

MULTI

MAXI

NIPPLE PIPES FOR DRINKING CUPS

- 94039 NIPPLE PIPE, 1/2", 830 MM, WITH THREAD, STAINLESS STEEL
- 06902111 NIPPLE PIPE, 1/2", 990 MM, WITH THREAD, STAINLESS STEEL
- 06902112 NIPPLE PIPE, 1/2", 1190 MM, WITH THREAD, STAINLESS STEEL
- 06902113 NIPPLE PIPE, 1/2", 1700 MM, WITH THREAD, STAINLESS STEEL

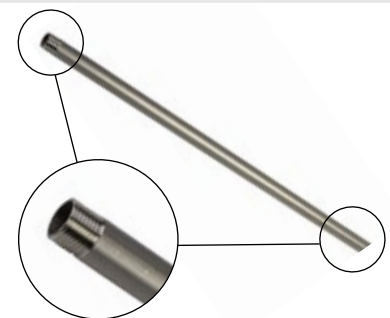

Thread in both ends

STAINLESS STEEL DRINKING CUP

- 2100622 PIGLET DRINKER, PIPE LENGTH 130 MM, STAINLESS STEEL
- 2100625 PIGLET DRINKER, PIPE LENGTH 352 MM, STAINLESS STEEL

PIGLET DRINKER

- 43730 PIGLET DRINKER



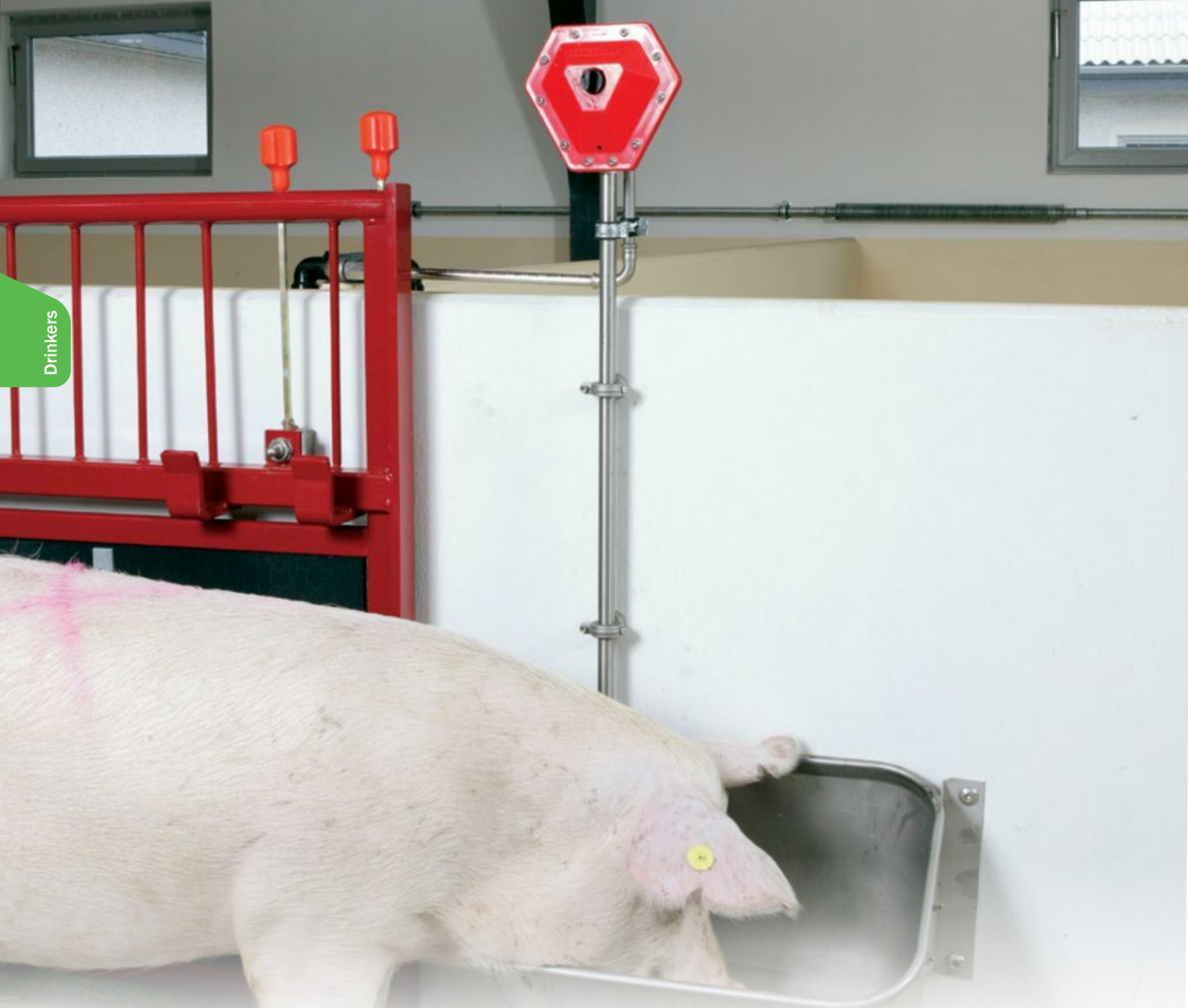

MASTER FLOW

Water supply to ensure a constant water level in the trough

MASTER FLOW water level valve has two entrances with 1/2" internal threads for horizontal and vertical water pipes. Recommended water pressure: 2,5 Bar

- 93469 MASTER FLOW INCL. 1/2" PLUG

MOUNTING KITS

- 4900485 MOUNTING KIT MASTER FLOW, 1" FRONT BARS
- 4900486 MOUNTING KIT MASTER FLOW, VERTICAL BARS
- 4900487 MOUNTING KIT MASTER, BOARD PROFILE
- 4900488 MOUNTING KIT, PANEL
- 4900489 MOUNTING KIT, WALL

NIPPLE PIPES FOR MASTER FLOW

- 06902114 NIPPLE PIPE 1/2', 1195 MM, WITH THREAD, STAINLESS STEEL
- 06902115 NIPPLE PIPE 1/2', 1495 MM, WITH THREAD, STAINLESS STEEL

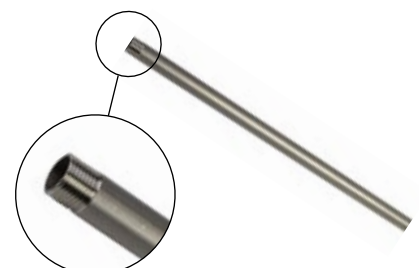

Thread in one end



Drinkers

TILTABLE TROUGH



Trough for sows and weaners, easy to empty



■ 1205902



■ 1205901



■ 1205903

Item no.	1205902	1205901	1205903
For	Sows	Piglets	Piglets
No. of animals per trough	15-20	25-40	25-40
Material	Plastic / Stainless steel	Plastic / Stainless steel	Stainless steel
Trough capacity, l	10	1	1

DRINKING VALVES

A great selection of valves to fit all of our drinkers and feeders

TYPES

Pressure valves
Tilt valves
Bite valves

WATER PRESSURE

Recommended: 2,5 Bar

- Threads to fit pipes of several sizes
- Capacities to meet the requirements for water volumes
- Most of our drinking valve types are adjustable in water amount

PRESSURE VALVES

- 281490 PRESS NIPPLE 3IN1, 1/2' EXTERNAL THREAD, STAINLESS STEEL



- 12100342 PRESS NIPPLE TYPE 11, 1/2' INTERNAL THREAD, STAINLESS STEEL



- 93305 PRESS NIPPLE 1/2' INTERNAL THREAD, STAINLESS STEEL



- 12309005 WATER VALVE TYPE 5, 1/4' EXTERNAL THREAD, STAINLESS STEEL



TILT VALVES

- 93250 PRESS NIPPLE DRIK-O-MAT, 1/2' EXTERNAL THREAD, STAINLESS STEEL



- 560153 VALVE FOR DRINKING BOWL, 1/2' EXTERNAL THREAD, STAINLESS STEEL



TILT VALVES

- 281496 PRESS NIPPLE FOR TUBE-O-MAT FEEDER, 1/2' EXTERNAL THREAD, STAINLESS STEEL



- 93245 PRESS NIPPLE TUBE-O-MAT, 3/8' INTERNAL THREAD, STAINLESS STEEL



- 9900047 PRESS NIPPLE TYPE 17, 1/2' INTERNAL THREAD, STAINLESS STEEL



- 93280 PRESS NIPPLE SOWS 1/2' EXTERNAL THREAD, STAINLESS STEEL



- 12100107 DRINKING VALVE TYPE 13, 1/2', STAINLESS STEEL



BITE VALVES

- 9900053 BITE NIPPLE, 1/2' EXTERNAL THREAD, FOR WEANERS, STAINLESS STEEL
- 9900054 BITE NIPPLE, 1/2' EXTERNAL THREAD, FOR FINISHERS, STAINLESS STEEL



- 93345 BITE NIPPLE FOR PIGLETS, 3/8' EXTERNAL THREAD, STAINLESS STEEL
- 93343 BITE NIPPLE FOR SOWS, MALE THREAD 1/2', STAINLESS STEEL



- 9900058 BITE NIPPLE FOR SOWS, MALE EXTERNAL THREAD 1/2', BRASS



PRESSURE VALVES*

Article no.	Description	Adjustable	L/min (at 2,5 bar)	Thread
281490	Pressure valve 3in1	yes	4	1/2' int.
12100342	Pressure valve 3in1, type 11	yes	4	1/2' int.
93305	Pressure valve	yes	4,5	1/2' int.
12309005	Pressure valve 1/4', type 5	no	-	1/4' ext.

TILT VALVES*

Article no.	Description	Adjustable	L/min (at 2,5 bar)	Thread
93250	Tilt valve for DRIK-O-MAT	yes	4	1/2' ext.
560153	304 valve for drinking cup	yes	7	1/2' ext.
281496	Tilt valve for Tube-O-Mat pipe	yes	4	1/2' ext.
93245	Tilt valve for Tube-O-Mat	no	4	3/8' int.
9900047	Tilt valve, type 17	no	7	1/2' int.
93280	Tilt valve sows 13	no	4	1/2' ext.
12100107	Drinking valve 1/2', type 13	yes	5	1/2' int.

BITE VALVES*

Article no.	Description	Adjustable	L/min (at 2,5 bar)	Thread
9900053	Bite valve, weaners	yes	2,5	1/2' ext.
9900054	Bite valve, finishers	yes	4	1/2' ext.
93345	Bite valve, piglets	yes	1,5	3/8' ext.
93343	Bite valve sows, brass	yes	6,5	1/2' ext.
9900058	Bite valve sows	no	3	1/2' ext.

*Recommended water pressure: 2,5 Bar.

FARROWING

With 50 years of experience of producing farrowing pens, MASTER TRADING brings you to the top with high quality equipment. You can find traditional farrowing pens, extra large crates and multi-adjustable crates.

Furthermore, the piglets can be sheltered by a covered piglets nest with insulating rubber mats and heating lamps.



Farrowing



FARROWING PENS

Traditional farrowing pen with multi-adjustable crate

FACTS

Pen length	260/270 cm
Pen width	160/170/180 cm
Pen height	50 cm
U-profiles	1,5 mm stainless steel
Board profiles	35 x 500 mm
Lying length	200-210 cm
Width farrowing crate, front	52-61 cm
Width farrowing crate, rear gate	57-85 cm
Height crate side	90 cm
Farrowing crate trough rail	40 x 40 x 4 mm / 50 x 50 x 4 mm
Crate side	33,7/42,4 x 2,65 pipe
Volume trough	21 liters
Piglets nest width	80/90 cm
Piglets nest area	0,7/0,8 m ²

Maximum production

- More weaned piglets and higher weight at weaning
- Ergonomic design of the crate ensures a safe movement behaviour
- The piglets have free access to the udder
- Maximum feed and water intake
- Large hygienic trough and crate design, that makes it easy for the sow to get up

FUNKI FARROWING PENS

We offer several solutions when it comes to the construction of farrowing pens. The farrowing pens can be constructed with different types of board profiles, each with its special characteristics and designed for different specific needs. Below, you can get an overview of our standard solutions, so you can choose the solution that best fits your stable. Of course, our sales managers are always ready to guide you.

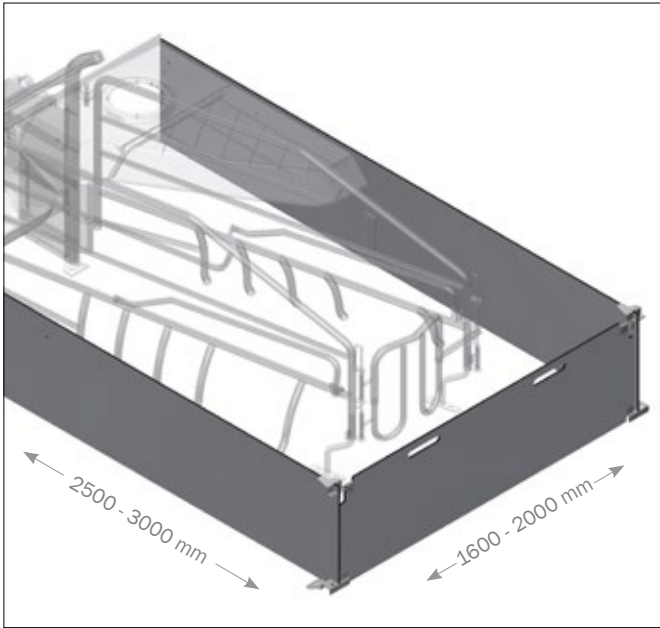

▲ FIBER FARROWING PEN

The pen built of solid panels with good resistance to diseases and bacterial infections. Fittings in steel. Easy to clean. No sharp edges and corners where hoses can get caught during washing. Considerably thinner board profiles, which gives more optimum space utilization as well as more pen space per m2.

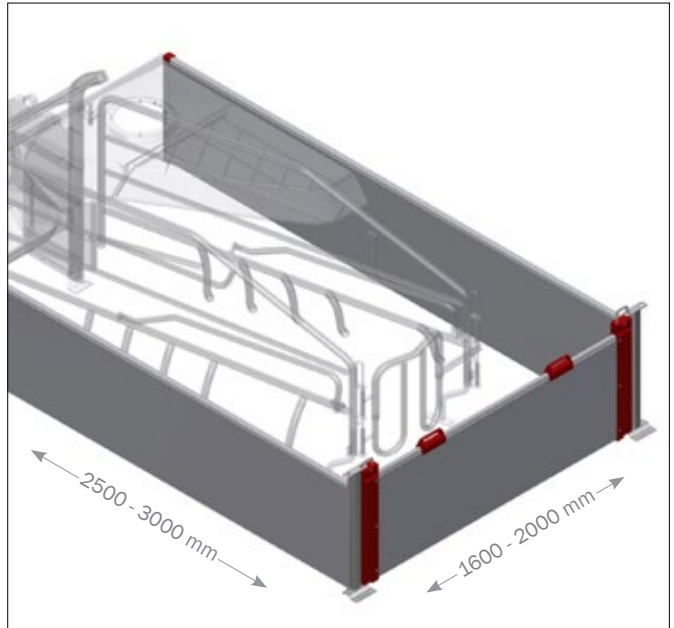

▲ STAINLESS FARROWING PEN

The pen with stainless steel bars and fittings. Easy to open. Easy to clean. Tiltable rear part operated with one hand.

Farrowing

INN-O-CRATE FARROWING PENS

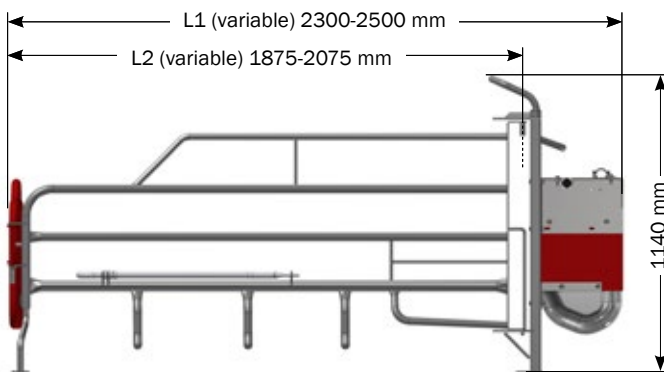

XL short, with tiltable wings (2700325)

and

XL short, with tiltable wings and upper structure (2700300)

L1 (incl.rear gate): 2300 mm

L2 (incl.rear gate): 1875 mm

XL standard, with tiltable wings (2700320)

and

XL standard, with tiltable wings and upper structure (2700302)

L1 (incl.rear gate): 2400 mm

L2 (incl.rear gate): 1975 mm } + 50 or 100 mm

FUNKI FARROWING PENS

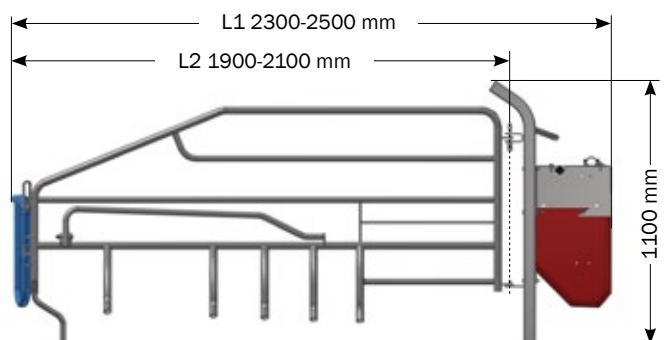

Farrowing partition F207 with tiltable wing (2100563)

L1 (incl. rear gate): 2500 mm

L2 (incl. rear gate): 2100 mm

Farrowing partition F200S with tiltable wing, short model (2100144)

L1 (incl. rear gate): 2300 mm

L2 (incl. rear gate): 1900 mm

Farrowing partition F200S without tiltable wing, with upper structure (2100612)

L1 (incl. rear gate): 2300 mm

L2 (incl. rear gate): 1900 mm

ACCESSORIES FOR FARROWING PENS



FARROWING RAILS

- 2700040 FARROWING RAIL INN-O-CRATE WITHOUT FRONT PART
- 2700562 FARROWING RAIL E208C WITHOUT FRONT PART
- 2100562 FARROWING RAIL F208C WITHOUT FRONT PART
- 2100850 FARROWING RAIL F208 WITHOUT FRONT PART



FARROWING PARTITIONS

- 2700320 FARROWING PARTITION XL STANDARD, WITH TILT FENDER
- 2700325 FARROWING PARTITION XL SHORT, WITH TILT FENDER
- 2100563 FARROWING PARTITION F207, WITH TILT FENDER
- 2100144 FARROWING PARTITION F200S, WITH TILTING BOW
- 2100612 FARROWING PARTITION F200S, EXPORT

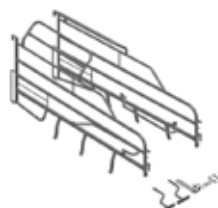

- 2700302 FARROWING PARTITION XL STANDARD, WITH TILT FENDER AND TOP BAR
- 2700300 FARROWING PARTITION XL SHORT, WITH TILT FENDER AND TOP BAR



REAR GATES

- 42335RD REAR GATE FOR FARROWING BOX XL, REVERSIBLE, RED
- 2720144 REAR GATE FARROWINGBOX XL GALVANIZED, REVERSIBLE
- 2116509 REAR GATE MODEL SOFT 3/4", LEFT-OPENED
- 2120509 LEFT REAR GATE GALVANIZED, SOFT 3/4"
- 2116510 REAR GATE MODEL SOFT 3/4", RIGHT-OPENED
- 2120510 RIGHT REAR GATE GALVANIZED, SOFT 3/4"
- 2115051 REAR GATE F200, 45-65 CM, GALVANIZED

ACCESSORIES FOR FARROWING PENS



- 2100776 WATER PIPE KIT FOR SOWS WITH PVC, WATER SUPPLY
- 2100652 WATER PIPE KIT FOR SOWS WITH STAINLESS STEEL, WATER SUPPLY
- 2700135 WATER PIPE KIT FOR TILT TROUGH, STAINLESS STEEL
- 2700155 WATER PIPE KIT FOR TILT TROUGH



DRY FEEDING SETS

- 0221-210 DRY FEEDING SET FOR PVC WATER
- 0221-211 DRY FEEDING SET FOR STAINLESS STEEL WATER

SOW TROUGHS FOR FARROWING PENS

TROUGH - PLASTIC

- 2100630 TROUGH KIT, FOR PLASTIC TROUGH



- 2900535 INTEGRATED DOWNPIPE, FOR PLASTIC TROUGH



TROUGHS - STAINLESS STEEL

- 2950666 SOW TROUGH, DEEP DRAWN, STAINLESS STEEL

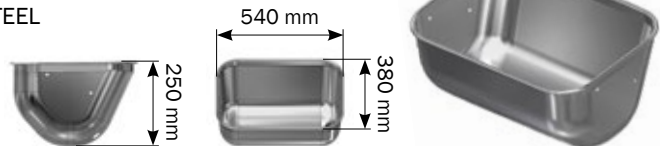

- 2700626 TILT TROUGH KIT GALVANIZED



- 2100790 TROUGH KIT, FOR STAINLESS STEEL TROUGH



- 2900711 SOW TROUGH, WITH HOLE AND INTEGRATED DOWN PIPE, LEFT
- 2900712 SOW TROUGH, WITH HOLE AND INTEGRATED DOWN PIPE, RIGHT



INN-O-CORNER®

PIGLET NEST

Ensures the optimum climate for piglets

FACTS

Material:	PP
Sizes:	80 cm (0,68 m ²) 90 cm (0,80 m ²)

- Optimum climate
- Closed side construction and tight joints between the cover area and the fixed part
- Up to 0,8 m² covered area
- Individual adjustment possible
- Easy access - light construction
- Slope on all cover parts; makes them easy to clean

Blocking plate for INN-O-CORNER®

- Matches INN-O-CORNER in design and function
- Easy inspection - free view of the piglets
- Lightweight - easy to handle

INN-O-CORNER

- 44080 INN-O-CORNER 80 CM, LEFT
- 44090 INN-O-CORNER 80 CM, RIGHT
- 44060 INN-O-CORNER 90 CM, LEFT
- 44070 INN-O-CORNER 90 CM, RIGHT

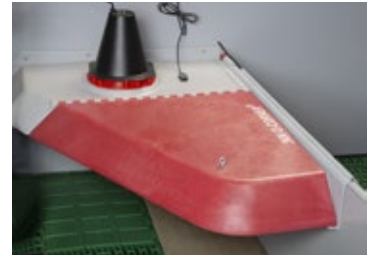

BLOCKING PLATES

- 8460390 BLOCKING PLATE FOR INN-O-CORNER, 1220X290 MM
- 44215 BLOCKING PLATE, 80 CM
- 44210 BLOCKING PLATE FOR INN-O-CORNER, 90 CM



- 2900855 MOBILE NEST

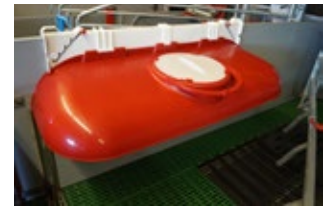

MOUNTING PROFILES

- 43516* INN-O-CORNER PROFILE, LEFT, AGAINST BOARD PROFILE
- 43511* INN-O-CORNER PROFILE, RIGHT, AGAINST BOARD PROFILE
- 43517* INN-O-CORNER PROFILE, LEFT, AGAINST WALL
- 43512* INN-O-CORNER PROFILE, RIGHT, AGAINST WALL
- 44008 INN-O-CORNER TOP PROFILE, DOUBLE

* Incl. bolts



RUBBER MATS

- 44112 RUBBER MAT FOR PIGLETS NEST, 80 CM, REVERSIBLE
- 44118 RUBBER FLOOR PIGLETS NEST 90 CM REVERSIBLE
- 27000024 RUBBER MAT FOR PIGLETS NEST, ONE ROLL, W=1,2 M, L=30 M
- 7910116 RUBBER MAT ONE ROLL WIDE 1,2 METER, SPECIAL LENGTH



HEATING LAMPS

Master Lamp and Master Heater

MASTER LAMP and FUNKI LAMP

Effect Up to 150 W
Cable 250 cm

MASTER HEATER

Variants 150W / 150W, 10V
Cable 240 cm

Master Lamp

- Splash proof (IPX4)
- Bayonet socket - easy to mount on the cover of the piglet nest
- Available with regular plug (SCHUKO plug)

Master Heater

- Reduced energy consumption
- Even distribution of heat
- Waterproof IPX9K approved
- Long life expectancy
- Extra low fire risk
- No plug

HEATING LAMPS

MASTER LAMP

- 9976342 MASTER LAMP, CE PLUG, COMPLETE
- 9971028 HEAT BULB 150W RED BOX WITH 2 PCS.
- 9971020 HEAT BULB 150W WHITE BOX WITH 2 PCS.



ACCESSORIES FOR MASTER LAMP

- 2960510 LID FOR HEATING LAMP



- 2900588 ADAPTER FOR HEATING LAMP



MASTER HEATER

Heating lamps for farrowing pens and finisher pens

- Providing more even distribution of heat than traditional heat lamps. This ensures better feed intake and higher survival rates among piglets and reduces the medicine use.
- Reduces energy consumption in the unit by up to 50% when combined with dual control
- Waterproof IPX9K approved
- Master Heater does not use incandescent light bulbs, like traditional heat lamps, but heating elements



- 560500 MASTER HEATER 100W, WITHOUT PLUG
- 560550 MASTER HEATER 150W, WITHOUT PLUG
- 560510 MASTER HEATER 150W, 110V WITHOUT PLUG
- 8440156 DRILLING TEMPLATE FOR MASTER HEATER



- 560502 DOUBLE CONTROLLER, FOR 2 MASTER HEATERS
- 560516 MULTI CONTROLLER A16, FOR 18 MASTER HEATERS



UNICOMFORT

Optimal heat control for your piglets

MASTER LAMP and FUNKI LAMP

Max power Up to 150 W
Cable 250 cm

MASTER HEATER

Variants 100W / 220W, 10V
Cable 240 cm

- Management of microclimate in piglets nest area. The UniComfort regulates the installed heaters in 2 pens separately with 2 sensors
- Keep the temperature stable for piglets in their critical life phase regardless of day/night or summer/winter influence.
- Solutions for weaners, finishers and sows
- Turns off heaters automatically after ending curve program

- 560594 UNICOMFORT FOR 2 FARROWING PENS WITHOUT PLUG





BABY CARE



Automatic milk feeding system



Ensures that all piglets have enough milk. When the piglets have constant access to milk, it results in a higher weight at weaning.

When the piglets are 1 kilo heavier at weaning, they have a faster growth after weaning and this gives a higher survival rate.

- Automatical distribution of milk to the farrowing pens
- 1-2 more piglets per sow in the litter
- Up to 1 kg higher weight at weaning
- Less need for extra nursing sows
- Less need to move the piglets
- Lower infection risk
- Automatic cleaning program

■ 2900900 BABY CARE MILK MIXER

■ 2900910 BABY CARE MILK MIXER INCL. ACID AND SOAP PUMP

Cleaning of tank at each mixture

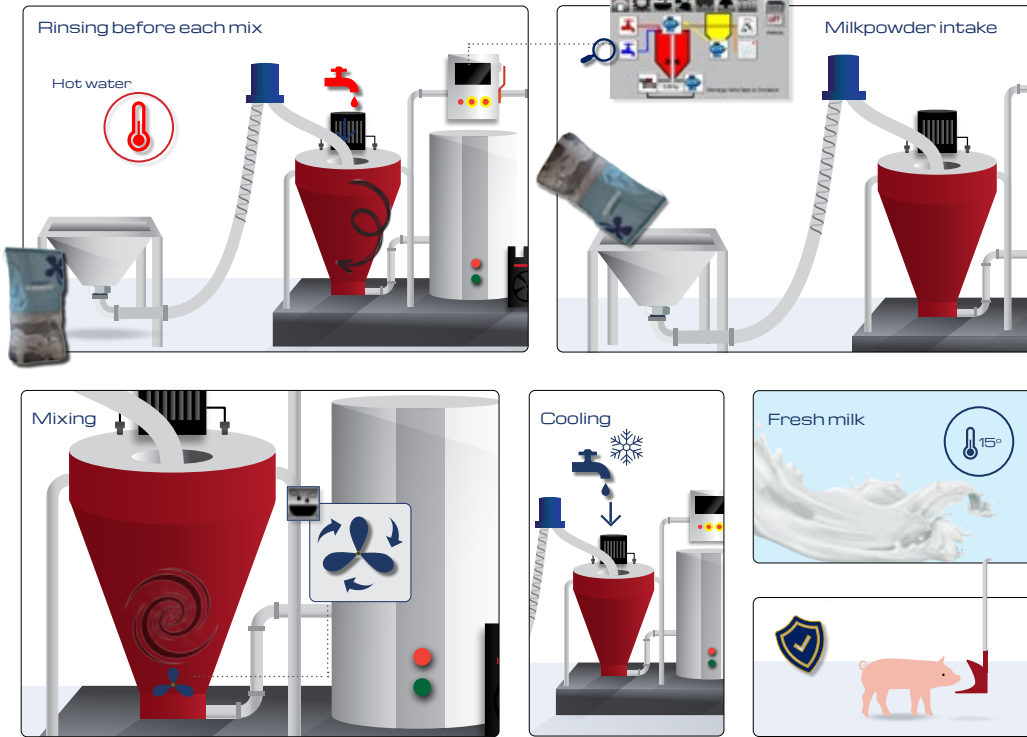

Farrowing

Automatic cleaning procedure

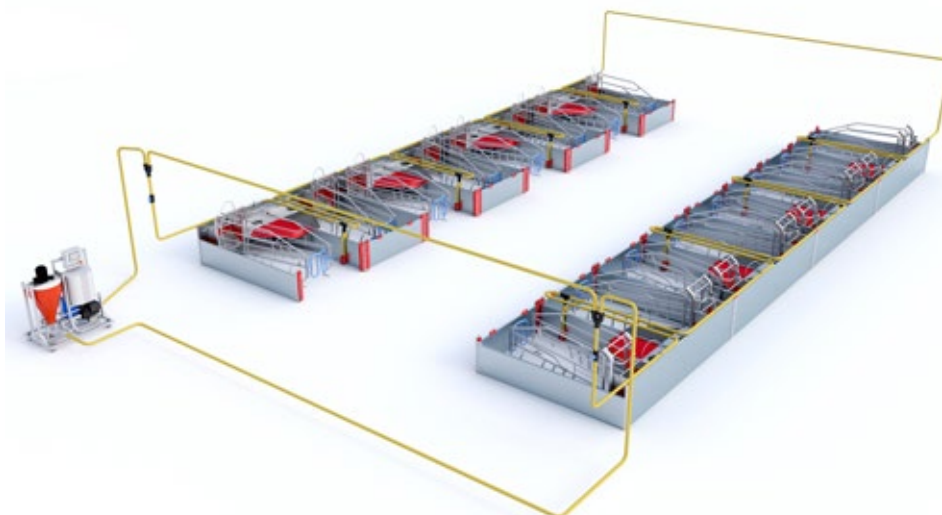
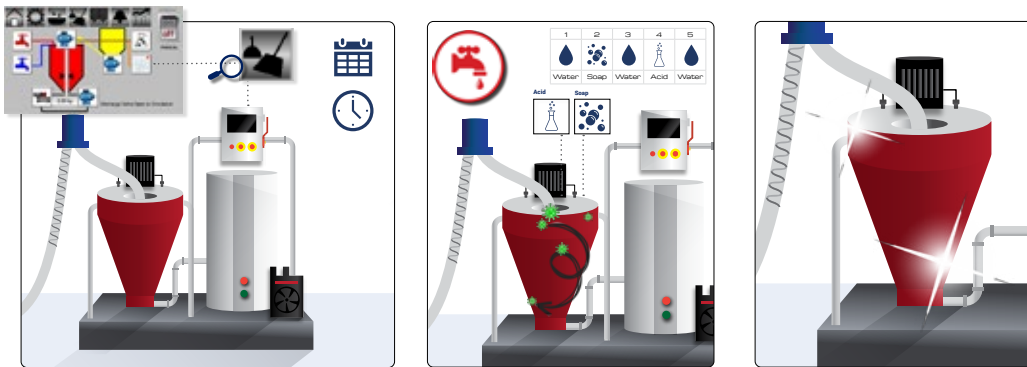

OPERATION PRINCIPLE

In the corridor between farrowing departments, there is one forward line and one return line. There are manual valves to select either water or milk for the piglets. Besides, there are valves for circuit cleaning.

MATING ACCESSORIES

Mating and gestation are a very important part in pig production. The sows spend a lot of their reproductive life in mating and gestation units.

Therefore, it is necessary that the unit and other components are well thought out, to ensure good and sustainable conditions for the sow and a productive and safe environment for the staff.



Mating
accs.

BOAR DOOR

Smart boar door with a special handle

This special boar door is designed in order to make the insemination process easier. Thanks to the long handle, the door can be open from the distance, without entering the mating box. To ensure long durability, the door can only be opened in one direction, as the lock stop is mounted (optional right or left). It makes it easier to close the door, when the boar has passed.

- Operated without entering the box
- Can be adjusted on site
- Reversible
- Easy to close

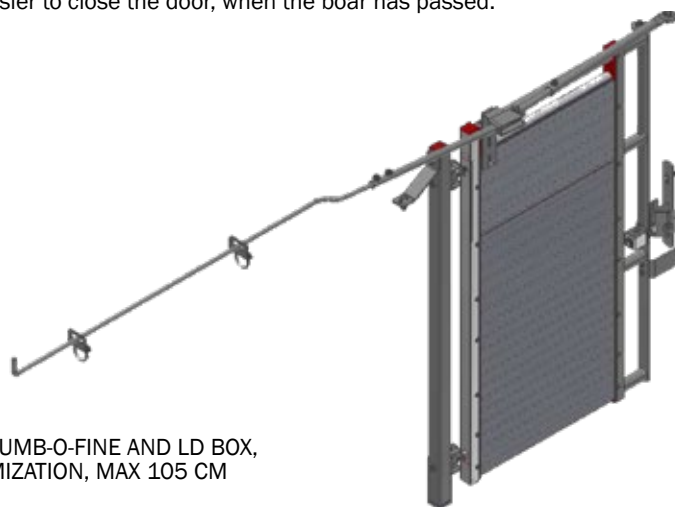

- 1900295 UNASSEMBLED MATING GATE H110, JUMB-O-FINE AND LD BOX, BOARDPROFILE/BAR ON-SITE CUSTOMIZATION, MAX 105 CM
- 1900274 KIT FOR MATING GATE JUMB-O-FINE AND LD BOX, W/PEN FRONT BARS AISLE WIDTH 70-105 CM



Mating
accs.

STIMULUS



Automatic stimulation of sows

- Efficient way to stimulate the sows
 - Get more total born piglets
 - The insemination can be carried out by just one employee
 - Easy to control the process
 - Built-in electronic controls the air pressure in the pump
 - The electronic is powered by a built-in rechargeable battery
-
- 560520 STIMULUS
 - 560521 SUPPORT MULTI FOR STIMULUS
 - 560522 INSEMINATION WAGON FOR STIMULUS 6 PLACE



**ENERGY SAVING
UP TO 60-80%**

Mating
accs.

LED-LIGHT

INN-O-LED "Plug and play" - Better heat for the sows, increased reproduction rate

INN-O-LED "Plug and play"

- Reduces energy consumption by min. 60-80% compared to other light sources (neon tubes or similar)
- Electricity savings up to 90% compared to light bulbs; lower CO2 emission
- Designed for pig housing environment - transformers and LEDs are "molded" together, thus making the setup incredibly durable
- Can tolerate moisture, dust and ammonia due to its unique construction
- Modular *Plug'n Play* system solution, where you can easily mount luminaires, incl. cables, - all by yourself
- Replacable LEDs and transformer ensure long durability and low operating costs. Possibility for continuous upgrade to new technology without changing the entire luminaire



- 560783 INN-O-LED CABLE MOUNTING LINER 4 METER



- 560590 INN-O-LED PLASTIC HOLDER SET



- 560771 INN-O-LED PIPE P/P 150CM/25W 4000K DIMMABLE



- 560772 INN-O-LED PIPE P/P 150CM/25W 6000K DIMMABLE



- 560766 INN-O-LED P/P 150CM/25W 4000K DIMMABLE



- 560767 INN-O-LED P/P 150CM/25W 6000K DIMMABLE



CONTROLLERS

- 0170-790 FUNKI MULTICONTROLLER EMPTY MOUNTING BOX
- 0170-797 FUNKI MULTICONTROLLER LIGHT "MASTER"
- 0170-798 FUNKI MULTICONTROLLER LIGHT "SLAVE"



FLOORING

Complete plastic and cast iron flooring program and related accessories. Well-proven through decades.

Our flooring product range is under constant development and optimization, and consists of multi-compatible plastic slats, cast iron slats, self-supporting slats and heating plates.

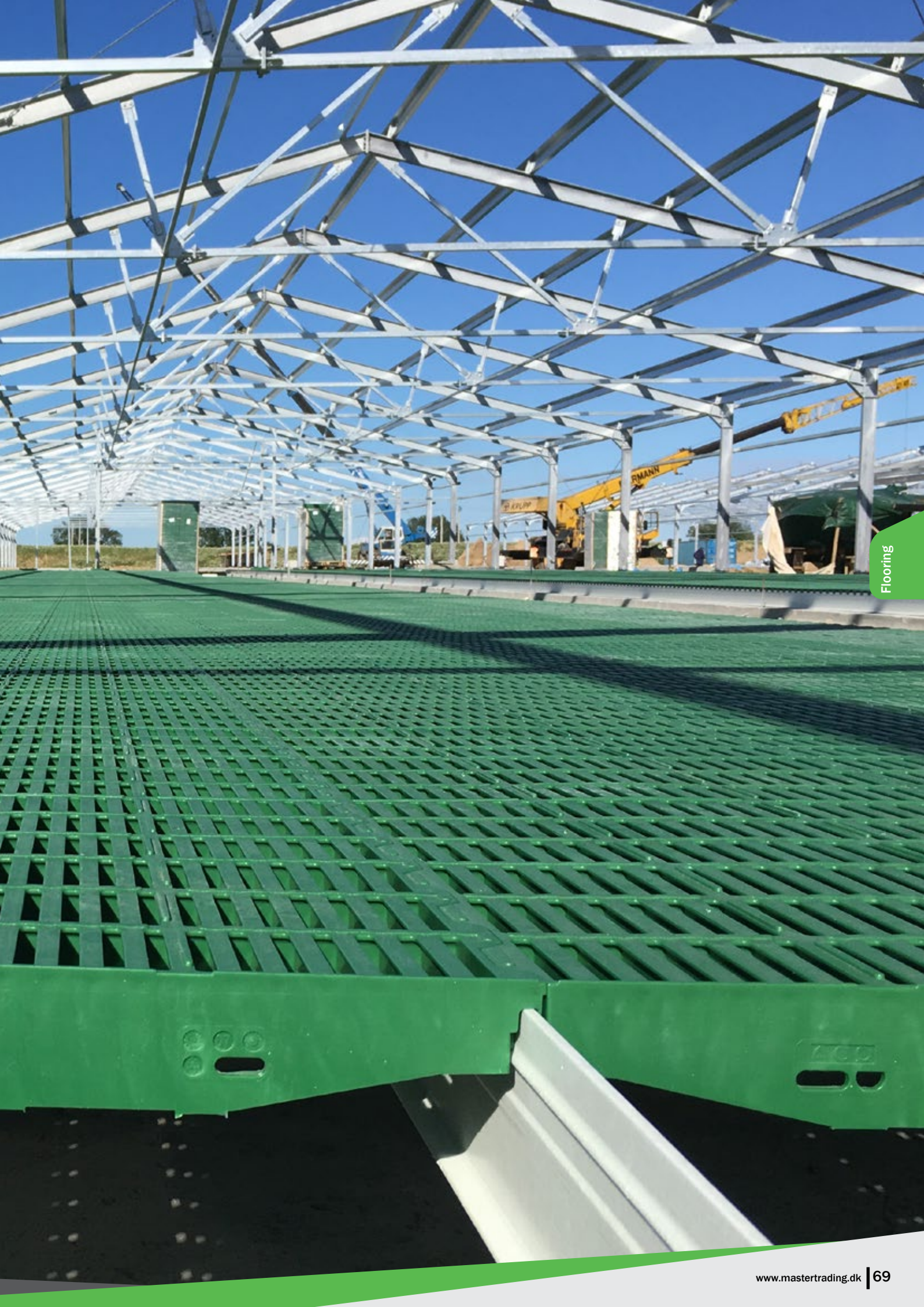

Flooring

COMBI-FLOOR

Wide assortment of plastic slats, cast iron slats, supports and heating plates

- High level of flexibility - the components can be combined according to your needs
- No recycling materials used for our plastic slats - only pure PP
- Cast iron material: GGG40



Slats with 5% opening, designed to reduce the risk of pressure sores, and to ensure that the sows have a dry and cool area to stay in.



Special plastic slats for weaners with an innovative, textured surface, that helps to keep weaners warm and dry.



Huge range of standard slats for weaners and sows

PLASTIC SLATS FOR WEANERS, 10% OPENING / CLOSED

- 18604 PLASTIC SLAT, FOR WEANERS, 60X40 CM, 10% OPENING
- 566260 PLASTIC SLAT, FOR WEANERS, 60X60 CM, 10% OPENING
- 566160 PLASTIC SLAT, FOR WEANERS, 60X60 CM, CLOSED

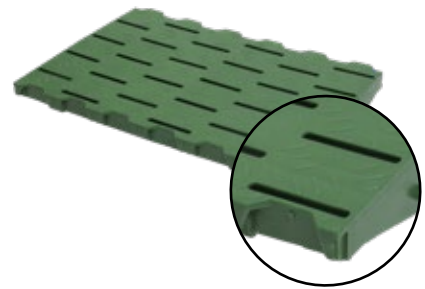

PLASTIC SLATS FOR WEANERS, 50% OPENING

- 09100 PLASTIC SLAT, FOR WEANERS, 60X40 CM
- 17384 PLASTIC SLAT, FOR WEANERS, 60X50 CM
- 566360 PLASTIC SLAT, FOR WEANERS, 60X60 CM

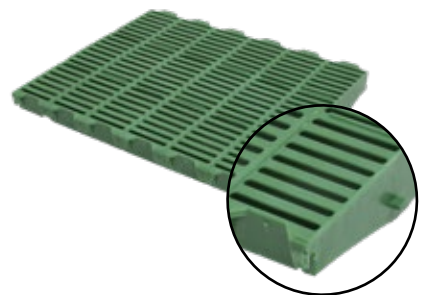

COMFORT PLATES

- 560310 POLYMER PLATE FOR FARROWING PEN, COMPLETE WITH 3 PCS. PLASTIC FRAMES
- 560300 PLASTIC GRATING FRAME 20X40 CM (3 PCS. PER 1 POLYMER PLATE)
- 560305 POLYMER PLATE FOR FARROWING PEN, 60X40 CM

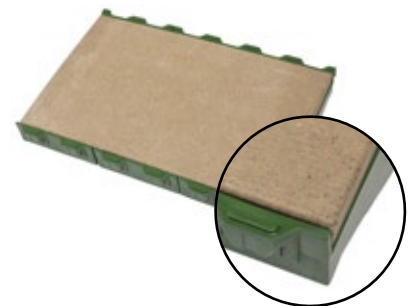

PLASTIC SLAT FOR SOWS, CLOSED

- 17383 PLASTIC SLAT, FOR SOWS, 60X40 CM



PLASTIC SLATS FOR SOWS, 50% OPENING

- 18054 PLASTIC SLAT, FOR SOWS, 10X40 CM
- 18094 PLASTIC SLAT, FOR SOWS, 30X20 CM
- 17328 PLASTIC SLAT, FOR SOWS, 30X30 CM
- 18721 PLASTIC SLAT, FOR SOWS, 30X60 CM
- 09102 PLASTIC SLAT, FOR SOWS, 60X40 CM
- 565060 PLASTIC SLAT, FOR SOWS, 60X50 CM

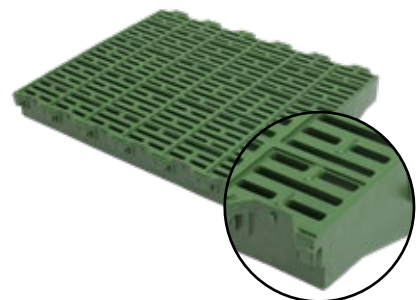



CAST IRON SLAT, 5% OPENING

- 566041 CAST IRON SLAT, FOR SOWS, 60X40 CM



CAST IRON SLATS, 50% OPENING

- 561060 CAST IRON SLAT, FOR SOWS, 10X60 CM
- 564060 CAST IRON SLAT, FOR SOWS, 40X60 CM
- 566040 CAST IRON SLAT, FOR SOWS, 60X40 CM
- 566060 CAST IRON SLAT, FOR SOWS, 60X60 CM



CAST IRON SLATS, 50% OPENING, WITH PLUG

- 563060 CAST IRON SLAT WITH PLUG, FOR SOWS, 30X60 CM
- 563063 CAST IRON SLAT WITH PLUG, FOR SOWS, 60X60 CM



CLEANING PLUGS FOR CAST IRON SLATS

- 563061 PLUG FOR ITEM NO. 563060
- 563064 PLUG FOR ITEM NO. 566063



SUPPORTS

- 560193 FIBERGLASS SUPPORT, 120X32 MM, 5,9 M
- 7910193 FIBREGLASS SUPPORT 120 X 32 MM SPECIAL LENGTH



- 560189 FIBERGLASS SUPPORT, 70X32 MM, 5,9 M
- 7910189 FIBREGLASS SUPPORT 70 X 32 MM SPECIAL LENGTH



DELTA SUPPORTS

- 560285 FIBERGLASS SUPPORT, 120X30 MM, 2,85 M (DELTA)
- 560290 FIBERGLASS SUPPORT, 120X30 MM, 9 M (DELTA)
- 7910290 FIBERGLASS SUPPORT 120 X 30 MM (DELTA) SPECIAL LENGTH

SUPPORT BRACKET FOR WALL

- 17234 WALL HOLDER, FOR FIBERGLASS AND STEEL SUPPORTS



- 2900630 MOUNTING KIT, WALL BRACKET FOR FLOOR



- 2100619 Z-SUPPORT 135 MM, FOR FIBERGLASS SUPPORT 120 MM, COMPLETE



MOUNTING BRACKETS

- 96982 MOUNTING BRACKET, FOR DELTA FIBERGLASS SUPPORT
- 560192 MOUNTING BRACKET, FOR FIBERGLASS SUPPORT

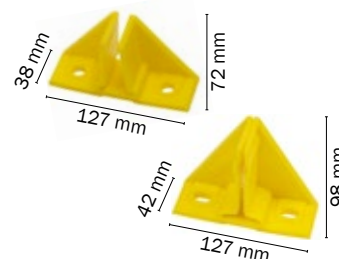

PVC PIPE

- 96981 PVC TUBE SUPPORT LEG, FIBERGLASS SUPPORT, LENGTH 5 METER



FOOT BRACKET

- 96980 FOOT BRACKET FOR SUPPORT LEG, FIBERGLASS SUPPORT



MAX. SPAN LENGTH, CM

	Weaner		Farrowing sows
Bearings	60x60 cm	60x40 & 60x50 cm	60x40 & 60x50 cm
70 x 32 mm	1500 mm	1600 mm	-
120 x 32 mm	2600 mm	2800 mm	2500 mm*
120 x 30 (Delta)	2800 mm	3000 mm	2500 mm*

* For regular farrowing pen: 3 supports under the sow.

* For Welsafe farrowing pen: supports under all bearings.

ACCESSORIES FOR COMBI-FLOOR

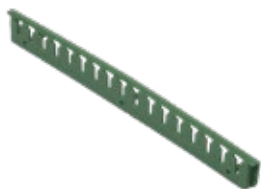

- 17667 FITTING FOR SOW SLATS, 40 CM, GREEN



- 560195 FILLERS FOR PLASTIC FLOOR



- 18083 CROSS-SECTION ADAPTER FOR PLASTIC SLATS, 20 CM



- 34900012 PAN HEAD ST 4.2X25 MM A2 DIN 7981C



- 8500301 SPACER FOR PP FLOOR, 30 X 40 X 58,3 MM



- 18169 MUCK TRAP FOR FARROWING PENS, 38,5 X 18,5 CM, STAINLESS STEEL



- 01777 CLEANING PLUG, L13 X W10 X H15 CM
- 554164 CLEANING PLUG, L21 X W13 X H7 CM



- 562500 SLOTTED SHUTTER QUICK MODEL, SMOOTH SURFACE, LENGTH 250 CM
- 562502 SLOTTED SHUTTER QUICK MODEL, GROOVED SURFACE, LENGTH 250 CM



Flooring





WATER HEATING PLATES, POLYMER CONCRETE

- 12631 WATER HEATING PLATE 120X40 CM, 120W WITH PVC PIPE INSERT, 1/2" FEMALE THRED
- 12633 WATER HEATING PLATE 120X50 CM, 120W WITH PVC PIPE INSERT, 1/2" FEMALE THRED
- 12630 WATER HEATING PLATE 140X50 CM, 140W WITH PVC PIPE INSERT 1/2" FEMALE THRED



- 17169 CONNECTING ANGLE, 2 PCS. PER SET FOR 17X2 MM



- 17317 HEATING PIPE 17X2 MM



TEMPERATURE CONTROLLER

- 560312 TEMPERATURE CONTROLLER FOR WATER HEATING PLATE, FOR 2 CIRCUITS
- 560313 TEMPERATURE CONTROLLER FOR WATER HEATING PLATE, FOR 3 CIRCUITS
- 560314 TEMPERATURE CONTROLLER FOR WATER HEATING PLATE, FOR 4 CIRCUITS



ACCESSORIES FOR HEATING PLATES

- 4960560 BRACKET KIT FOR HEATING PLATE
- 4960614 BRACKET KIT FOR HEATING PLATE, DELTA
- 17274 STEEL BRACKET FOR AXIAL DIMENSION 40 CM HEATING PLATES
- 17367 STEEL BRACKET FOR AXIAL DIMENSION 50 CM HEATING PLATES





FIRST CARE

Rubber heat mat for newborn piglets

FIRST-CARE RUBBER MAT:

Dimensions	350 x 860 x 10 mm
Connection	200-240 V
Energy consumption	320 W
Temperature	Default 39°C. Adjustable 30-45°C
Features	Ergonomic handles for easy placement
Cable	L=4,5 m, bite-resistant coating near the mat

TIMER:

Features	Built-in holder for placing on the partition
Start / stop	Possible to set delayed start
Running time	Can run continuously or for a time-limited period

FIRST-CARE RUBBER HEAT MAT

- Prevents undercooling
- Greater chance of survival - 0,2 more live pigs per litter
- Healthier pigs that recover faster after farrowing
- Mobile and easy - can be placed and removed again
- Non-slip surface
- Easy to clean and disinfect

- 560599 FIRST-CARE 220V RUBBER HEAT MAT, 350X850X10 MM

SELF-SUPPORTING CAST IRON SLATS

A sure-footed and comfortable solution for sows, weaners and finishers

MATERIAL

Cast iron GGG40

DIMENSIONS

FARROWING PENS

Rib	10 mm
Opening	11 mm
Cleaning opening	40 mm

WEANERS & WEAN-TO-FINISH

Rib	13 mm
Opening	12 mm
Cleaning opening	40 mm

FINISHERS

Rib	30 mm
Opening	15 mm
Cleaning opening	40 mm

The healthy condition

- Slightly textured surface makes the slat non-slip
- T-shaped ribs ensure optimal manure passage

Minimum cleaning time

- Large cleaning opening, hard surface and minimum surface area

Better environment and economy

- Long durability, self-supporting = low mounting costs

SELF-SUPPORTING CAST IRON SLATS

CAST IRON SLATS FOR FARROWING PENS

WITH CLEANING OPENING, 10/11 MM

- 560800 CAST IRON SLAT, FOR FARROWING PENS, 80 X 40 X 3 CM
- 560900 CAST IRON SLAT, FOR FARROWING PENS, 90 X 40 X 3 CM
- 561000 CAST IRON SLAT, FOR FARROWING PENS, 100 X 40 X 3 CM
- 561100 CAST IRON SLAT, FOR FARROWING PENS, 110 X 40 X 3 CM
- 549655 CAST IRON SLAT, FOR FARROWING PENS, 120 X 40 X 3 CM
- 561400 CAST IRON SLAT, FOR FARROWING PENS, 140 X 40 X 3 CM
- 561600 CAST IRON SLAT, FOR FARROWING PENS, 160 X 40 X 3 CM

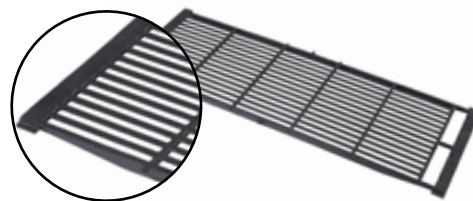

CAST IRON SLATS FOR WEANERS AND WEAN-TO-FINISH

WITH CLEANING OPENING, 12/13 MM

- 561203 CAST IRON SLAT, FOR WEAN-TO-FINISH, 120 X 40 X 3 CM
- 549800 CAST IRON SLAT, FOR WEAN-TO-FINISH, 140 X 40 CM
- 549656 CAST IRON SLAT, FOR WEAN-TO-FINISH, 160 X 40 CM
- 561803 CAST IRON SLAT, FOR WEAN-TO-FINISH, 180 X 40 X 3 CM
- 549849 CAST IRON SLAT, FOR WEAN-TO-FINISH, 200 X 40 CM

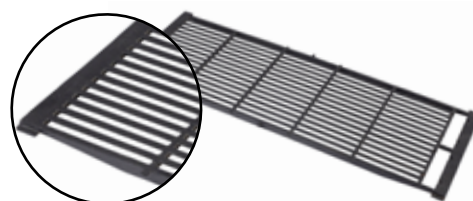

CAST IRON SLATS FOR FINISHERS

WITH CLEANING OPENING, 30/15 MM

- 95816 CAST IRON SLAT, FOR FINISHERS, 160 X 40 CM

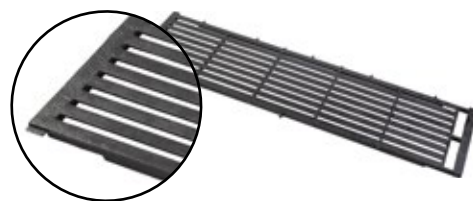

CAST IRON SLATS FOR SOWS WITH CLEANING OPENING, 10/11 MM

- 17339 CAST IRON SLAT, FOR SOWS, 80 X 50 CM
- 17341 CAST IRON SLAT, FOR SOWS, 100 X 50 CM, ANTI-SLIP
- 17342 CAST IRON SLAT, FOR SOWS, 120 X 50 CM, ANTI-SLIP

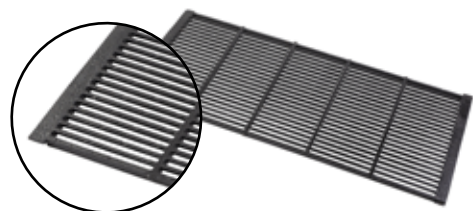

CAST IRON SLATS FOR SOWS WITH CLEANING OPENING, 26/16 MM

- 17253 CAST IRON SLAT, FOR SOWS, 100 X 50 CM, ANTI-SLIP
- 17197 CAST IRON SLAT, FOR SOWS, 80 X 75 CM, ANTI-SLIP

PLUGS

- 560111 PLUGS FOR CAST IRON SLATS 56XXXX



- 92630 PLUG FOR CAST IRON SLATS 92XXXX AND 54XXXX





BOARD PROFILES

Our equipment partitions consist of boards made from PVC or fiber material. Applicable to both types of boards is that they are strong and stable and have completely smooth surfaces, which ensures a great hygiene.

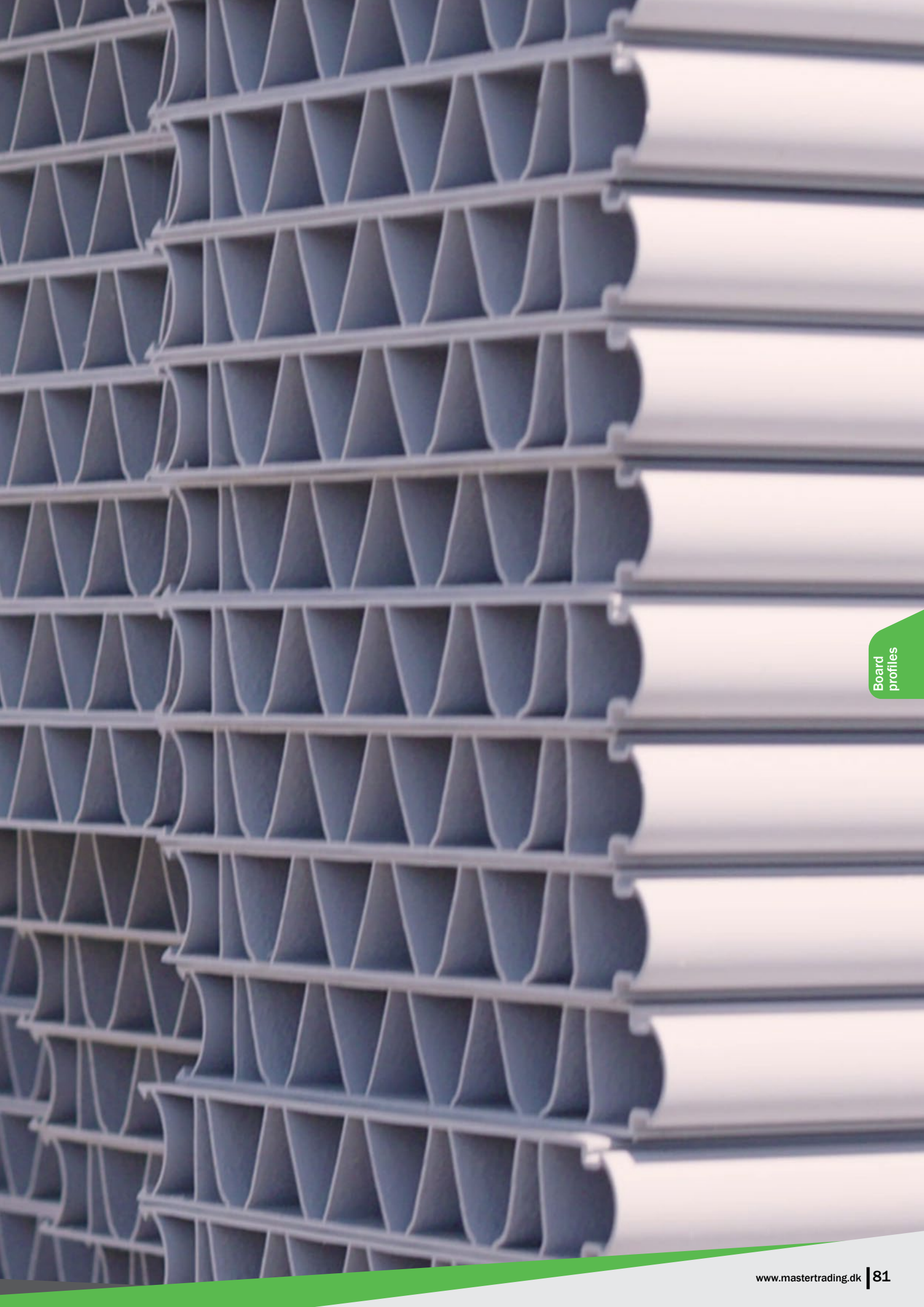

Board profiles



BOARD PROFILES

Durable and tight-fitting equipment

PVC BOARD PROFILES

MATERIAL	PVC
HEIGHT	
For 35 mm	250 mm 500 mm 750 mm

Hygiene and durability

- Tight, smooth and hard surface
- Rubber strips are adhered on outer side of board profiles for tighter joints
- Zig-zag lamellar structure provides torsional stiffness

CLEAN-O-FLEX® bottom profile

- Complements your CLEAN-O-FLEX® concept
- Sloped foot profile reduce the amount of manure on the equipment

- 8535076 BOARD PROFILE 35X70 OVAL 6 METER

PVC BOARD PROFILES

- 8535076 BOARD PROFILE 35X70 OVAL 6 METER



PVC BOARD PROFILES 35 MM, HEIGHT: 250 MM

- 7910099 35 X 250 MM, FEDER/NOT, PRICE PER M
- 30100 35 X 250 MM, FEDER/NOT, LENGTH 6 M

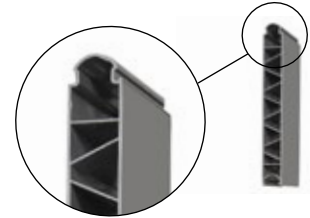

PVC BOARD PROFILES 35 MM, HEIGHT: 500 MM

- 7910102 35 X 500 MM, FEDER/NOT, PRICE PER M
- 30103 35 X 500 MM, FEDER/NOT, LENGTH 6 M

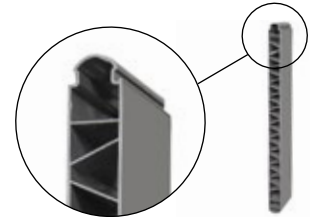

PVC BOARD PROFILES 35 MM, HEIGHT: 750 MM

- 7910105 35 X 750 MM, FEDER/NOT, PRICE PER M
- 30106 35 X 750 MM, FEDER/NOT, LENGTH 6 M

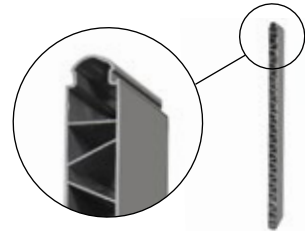

PVC BOARD PROFILES 35 MM

- 8535506 BOARD PROFILE 35X500 FLAT/FLAT 6 METER
- 8535756 BOARD PROFILE 35X750 FLAT/FLAT 6 METER
- 8535106 BOARD PROFILE 35X1000 FLAT/FLAT 6 METER

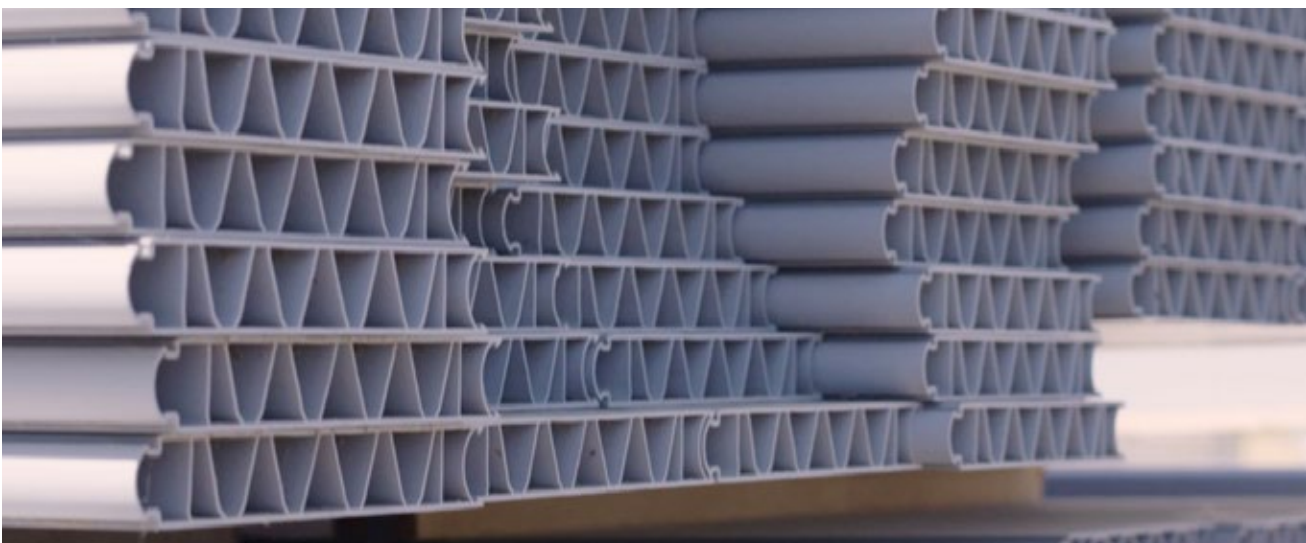
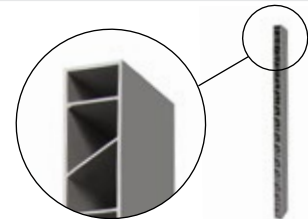



PROFILES FOR PVC BOARDS

- 2900358 U-PROFILE, LENGTH 6,5 M, PVC
- 7910358 U-PROFILE PVC SPEC LENGTH



- 2900359 HAT PROFILE, LENGTH 6,5 M, PVC
- 7910359 HATPROFILE PVC SPEC LENGTH



- 2900361 H-PROFILE, LENGTH 6,5 M, PVC
- 7910361 H-PROFILE PVC SPEC LENGTH



FIBER BOARD PROFILES

- 96997 COMPACT PLATE 10 X 4200 X1300 MM, GREY



PROFILES FOR FIBER BOARDS

- 9340400 PROFILE FOR LAMINATE PLATE, PVC

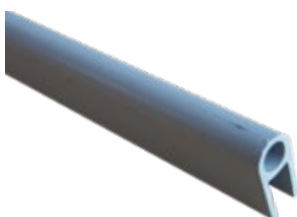

COVER FOR 8 MM PE HOSE

- 8500300 COVER FOR 8 MM PE-HOSE, FOR LAMINATE PLATE, 3 METER
- 30160 COVER FOR 8 MM PE-HOSE, 5900 MM

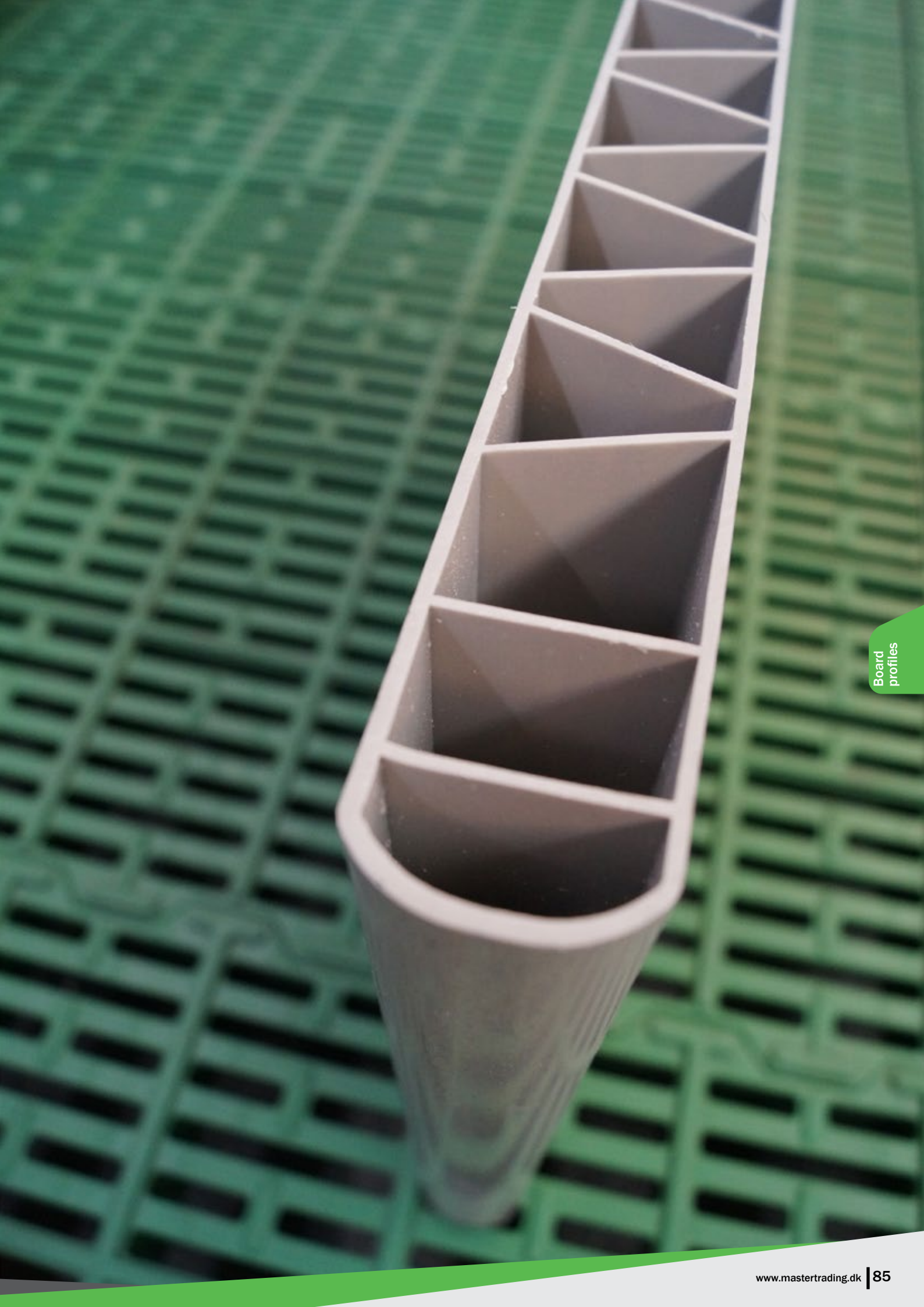



CLIMATE COVERS

Ensure a protective and draft-free area for weaners with the intelligent and waterproof climate covers made from lightweight, 15 mm PVC boards.

We offer flexible covers in several different variants.



Climate covers



FLEXCOVER®

CLIMATE COVER



Climate cover made of 15 mm PVC board profiles

Climate covers

DEPTH* (CM)	SECTIONS (CM)
85, straight	25 / 50
110, straight	50 / 50 25 / 75
116, straight	25 / 50 / 25
135, straight	50 / 75
160, straight	75 / 75
110, sloped	25 / 75
135, sloped	50 / 75

*Maximum width is 300 cm. If the width exceeds 300 cm, an extra support post is required (3100314)

Several design options for piglet covers

- PVC with rounded profiles all over; no sharp edges
- Light, but at the same time durable construction with 15 mm plastic board profiles
- Tight fittings ensure top hygiene and easy cleaning
- Developed for modern pig production with many washings
- Hinge rails with flexible rubber hinges ensure a draft-free environment
- Many built-in options with 25, 50 and 75 cm board profiles in combination with flexible hinge rails

FLEXCOVER 85 CM, 25/50

- 4900586 2-PARTS 25/50, DEPTH 85 CM, 3000 MM, SALES SET
- 4900585 2-PARTS 25/50, DEPTH 85 CM, 2500 MM, SALES SET

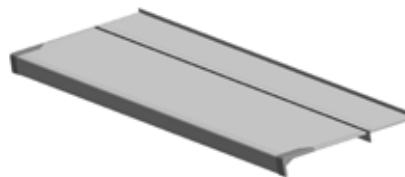

FLEXCOVER 110 CM, 50/50

- 4900611 2-PARTS 50/50, DEPTH 110 CM, 3000 MM, SALES SET
- 4900610 2-PARTS 50/50, DEPTH 110 CM, 2500 MM, SALES SET

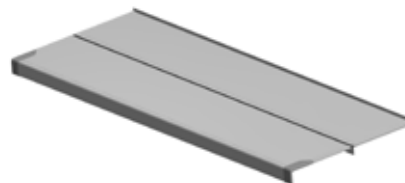

FLEXCOVER 110 CM, 25/75

- 4900613 2-PARTS 25/75, DEPTH 110 CM, 3000 MM, SALES SET
- 4900612 2-PARTS 25/75, DEPTH 110 CM, 2500 MM, SALES SET

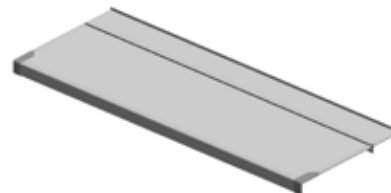

FLEXCOVER 135 CM, 50/75

- 4900636 2-PARTS 50/75, DEPTH 135 CM, 3000 MM, SALES SET
- 4900635 2-PARTS 50/75, DEPTH 135 CM, 2500 MM, SALES SET

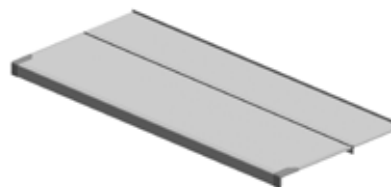

FLEXCOVER 160 CM, 75/75

- 4900661 2-PARTS 75/75, DEPTH 160 CM, 3000 MM, SALES SET
- 4900660 2-PARTS 75/75, DEPTH 160 CM, 2500 MM, SALES SET

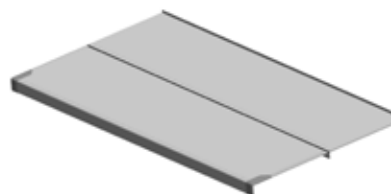

FLEXCOVER 116 CM, 25/50/25

- 4900747 3-PARTS 25/50/25, DEPTH 116 CM, 3000 MM, SALES SET
- 4900716 3-PARTS 25/50/25, DEPTH 116 CM, 2500 MM, SALES SET

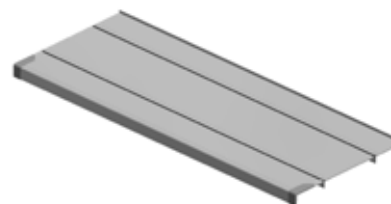

Climate covers

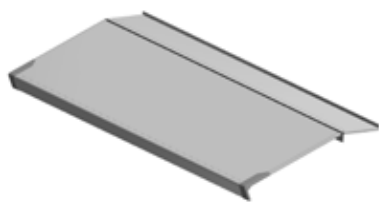

FLEXCOVER 110 CM, 25/75, SLOPED

- 4900711 2-PARTS 25/75, DEPTH 110 CM, 3000 MM, SALES SET
- 4900710 2-PARTS 25/75, DEPTH 110 CM, 2500 MM, SALES SET

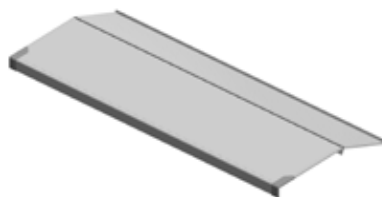

FLEXCOVER 135 CM, 50/75, SLOPED

- 4900736 2-PARTS 50/75, DEPTH 135 CM, 3000 MM, SALES SET
- 4900735 2-PARTS 50/75, DEPTH 135 CM, 2500 MM, SALES SET

ACCESSORIES FOR FLEXCOVERS

- 31378 HAT PROFILE, FOR 85 CM FLEXCOVER
- 31391 V-RAIL, FOR 85 CM FLEXCOVER, ON WALL
- 31392 V-RAIL, FOR 85 CM FLEXCOVER, ON BOARD PROFILE

- 31375 HAT PROFILE, FOR 110 CM FLEXCOVER
- 31385 V-RAIL, FOR 110 CM FLEXCOVER, ON WALL
- 31386 V-RAIL, FOR 110 CM FLEXCOVER, ON BOARD PROFILE

- 31381 HAT PROFILE, FOR 116 CM FLEXCOVER
- 31383 V-RAIL, FOR 116 CM FLEXCOVER, ON WALL
- 31384 V-RAIL, FOR 116 CM FLEXCOVER, ON BOARD PROFILE

- 31376 HAT PROFILE, FOR 135 CM FLEXCOVER
- 31387 V-RAIL, FOR 135 CM FLEXCOVER, ON WALL
- 31388 V-RAIL, FOR 135 CM FLEXCOVER, ON BOARD PROFILE

- 31377 HAT PROFILE, FOR 160 CM FLEXCOVER
- 31389 V-RAIL, FOR 160 CM FLEXCOVER, ON WALL
- 31390 V-RAIL, FOR 160 CM FLEXCOVER, ON BOARD PROFILE

- 31393 V-RAIL, FOR 110 CM SLOPED FLEXCOVER, ON WALL
- 31394 V-RAIL, FOR 110 CM SLOPED FLEXCOVER, ON BOARD PROFILE, SINGLE
- 31395 V-RAIL, FOR 110 CM SLOPED FLEXCOVER, ON BOARD PROFILE, DOUBLE

- 31396 V-RAIL, FOR 135 CM SLOPED FLEXCOVER, ON WALL
- 31397 V-RAIL, FOR 135 CM SLOPED FLEXCOVER, ON BOARD PROFILE, SINGLE
- 31398 V-RAIL, FOR 135 CM SLOPED FLEXCOVER, ON BOARD PROFILE, DOUBLE

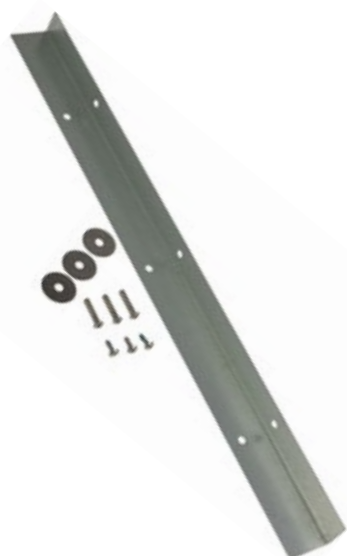

OPENING SET FOR FLEXCOVER

- 92509 OPENING SET FOR FLEXCOVER, PER PEN



BOLT KIT FOR FLEXCOVER

- 39800 BOLT KIT, FOR 1 FLEXCOVER, AGAINST WALL
- 39801 BOLT KIT, FOR 2 FLEXCOVER, AGAINST BOARD PROFILE
- 39802 BOLT KIT, FOR 1 FLEXCOVER, AGAINST BOARD PROFILE



GLUE PEVICOL

- 23900112 GLUE PEVICOL, 0,5 KG, FOR APPROX. 25 CLIMATE COVERS



SUPPORT

- 3100314 SUPPORT, FOR DOUBLE FLEXCOVER





TROUGHS

Troughs for all age groups - weaners, finishers and sows. Optimized shape adapted to the feed intake behavior of the pigs. High level of hygiene, thanks to closed edges and smooth surfaces.

Troughs in stainless steel and more than 50 years of experience with producing polymer concrete troughs.

We are proud to present our trough program.





TROUGHS

STAINLESS STEEL

Made of strong stainless steel. Can be used for liquid feeding walls

Troughs

MATERIAL 1 mm stainless steel

LENGTH 60-590 cm

WEAN-TO-FINISH, FINISHERS, YOUNG SOWS - DOUBLE TROUGH

Volume per meter 49 l
Height 14,5 cm
Width upper/lower 49,7 cm / 20 cm

WEAN-TO-FINISH, FINISHERS, YOUNG SOWS - SINGLE TROUGH

Volume per meter 24,5 l
Height 14,5 cm
Width upper/lower 24 cm / 7 cm

WEANERS - DOUBLE TROUGH

Volume per meter 38 l
Height 12 cm
Width upper/lower 43 cm / 20 cm

WEANERS - SINGLE TROUGH

Volume per meter 16 l
Height 12 cm
Width upper/lower 20 cm / 6 cm

Well-designed and reliable

- **Animal welfare and hygiene**
Completely smooth surface on the inside = minimal risk of injuries to the animals and minimal accumulation of feed residue
- **Suited for both dry- and liquid feeding**
- **Minimum feed waste**
Inverted edges
- **Easy cleaning**
The troughs are mounted free of the floor allowing washing underneath them

STAINLESS STEEL TROUGHS

LOW STAINLESS STEEL TROUGHS FOR BOXES

- 96182 LOW STAINLESS STEEL TROUGH, WITH WELDED GABLE
- 1950302 LOW STAINLESS STEEL TROUGH WITH WELDED END PIECE AND DRAIN RIGHT
- 1950303 LOW STAINLESS STEEL TROUGH WITH WELDED END PIECE AND DRAIN LEFT
- 96181 LOW STAINLESS STEEL TROUGH, FOR PLASTIC JOINT
- 1950308 LOW STAINLESS STEEL TROUGH WITH DRAIN FOR PLASTIC END PIECE RIGHT
- 1950309 LOW STAINLESS STEEL TROUGH WITH DRAIN FOR PLASTIC END PIECE LEFT
- 1700045 END IN PLATIC FOR LOW STEEL TROUGH
- 1700046 ASSEMBLY KIT FOR LOW STEEL TROUGH
- 96202 BRACKET, FOR HIGH AND LOW TROUGHS

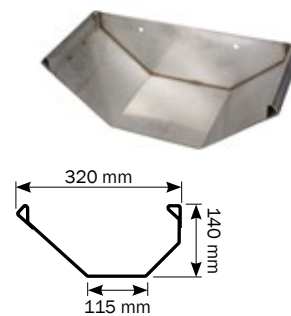

HIGH STAINLESS STEEL TROUGHS FOR BOXES

- 96180 HIGH STAINLESS STEEL TROUGH, FOR PLASTIC JOINT
- 1950306 HIGH STAINLESS STEEL TROUGH WITH DRAIN FOR PLASTIC END PIECE RIGHT
- 1950307 HIGH STAINLESS STEEL TROUGH WITH DRAIN FOR PLASTIC END PIECE LEFT
- 96183 HIGH STAINLESS STEEL TROUGH, WITH WELDED GABLE
- 1950304 HIGH STEEL TROUGH WITH WELDED END PIECE AND DRAIN RIGHT
- 1950305 HIGH STEEL TROUGH WITH WELDED END PIECE AND DRAIN LEFT
- 1700042 ASSEMBLY KIT FOR HIGH STEEL TROUGH
- 31040 END IN PLATIC FOR HIGH STEEL TROUGH
- 96202 BRACKET, FOR HIGH AND LOW TROUGHS

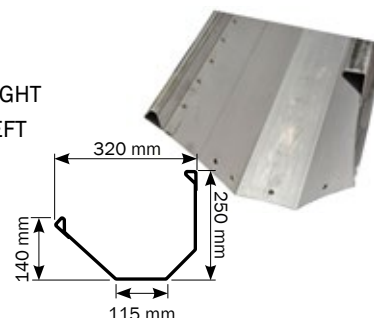

END PIECE FOR STAINLESS STEEL TROUGH

- 31025 END PIECE KIT FOR 1 STAINLESS STEEL TROUGH, PLASTIC



ASSEMBLY KIT FOR STAINLESS STEEL TROUGH

- 31030 ASSEMBLY KIT FOR 1 STAINLESS STEEL TROUGH, PLASTIC



STAINLESS STEEL TROUGHS FOR INN-O-WALL, LIQUID FEEDING WALL - SINGLE

- 39218 LIQUID FEEDING TROUGH, SINGLE, FOR WEANERS
- 1950315 LIQUID FEED TROUGH WEANER SINGLE WITH DRAIN, LEFT
- 1950316 LIQUID FEED TROUGH WEANER SINGLE WITH DRAIN, RIGHT
- 39211 LIQUID FEEDING TROUGH, SINGLE, FOR FINISHERS
- 1950312 LIQUID FEED TROUGH FINISHER SINGLE WITH DRAIN, LEFT
- 1950313 LIQUID FEED TROUGH FINISHER SINGLE WITH DRAIN, RIGHT

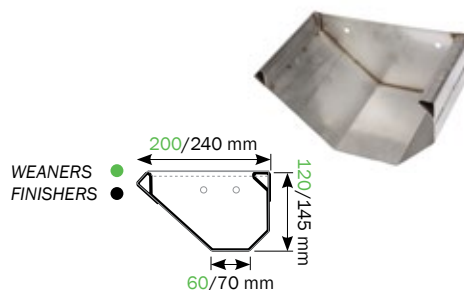

STAINLESS STEEL TROUGHS FOR INN-O-WALL, LIQUID FEEDING WALL - DOUBLE

- 39215 LIQUID FEEDING TROUGH, DOUBLE, FOR WEANERS
- 1950314 LIQUID FEED TROUGH WEANER DOUBLE WITH DRAIN
- 39234 LIQUID FEEDING TROUGH, DOUBLE, FOR FINISHERS
- 1950311 LIQUID FEED TROUGH FINISHER DOUBLE WITH DRAIN

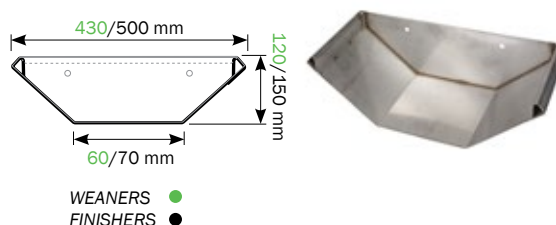



FOOT BRACKETS FOR TROUGHS

- 31000 BRACKET SET FOR DOUBLE TROUGH, FINISHERS
- 31002 SUPPORT LEG FOR DOUBLE TROUGH, WEANERS



- 31001 BRACKET SET FOR SINGLE TROUGH, FINISHERS
- 31003 SUPPORT LEG FOR SINGLE TROUGH, WEANERS



ADAPTER FOR SUPPORT LEG

- 30053 ADAPTER FOR SUPPORT LEG, 35 MM BOARD PROFILE
- 8530052 ADAPTER FOR SUPPORT LEG, 50 MM BOARD PROFILE



WALL BRACKETS FOR SINGLE STEEL TROUGH

- 31050 WALL BRACKET FOR SINGLE TROUGH, AGAINST WALL
- 31051 WALL BRACKET FOR SINGLE TROUGH, AGAINST BOARD PROFILE



- 2950666 SOW TROUGH DEEP DRAWN STAINLESS STEEL V2
- 96054 BRACKET SET, FOR SOW TROUGH, INCL. BOLT FOR WALL
- 96056 BRACKET SET, FOR SOW TROUGH, INCL. BOLT FOR BOARD PROFILE
- 96058 BRACKET SET, FOR SOW TROUGH, SINGLE, MOUNTING ON GRILLE



- 31052 WALL BRACKET FOR SINGLE TROUGH, DOUBLE, AGAINST BOARD PROFILE



BIOLINE TROUGHS

- 4560634 CENTRAL PLATE FOR BIOLINE COMPACT PLATE
- 4560635 END PLATE FOR BIOLINE COMPACT PLATE



Trouths



TROUGHS

POLYMER CONCRETE

Your guarantee for optimal profit, animal welfare and working environment in your pig production

Troughs

MATERIAL

Polymer concrete

LENGTH

100 / 120 cm

- Smooth surface to prevent accumulation of bacteria and manure
- Easy to clean
- Easy to mount
- Flexible; can be adjusted at the mounting place
- The most used trough principle in Europe for the past 30+ years
- 4 times stronger than regular concrete



POLYMER CONCRETE PRODUCTS

TS 30

- 01605 TS 30, 100 CM
- 17096 END TROUGH FOR TS 30, 100 CM
- 17097 END TROUGH FOR TS 30, 65 CM
- 01664 PARTITION FOR TS 30

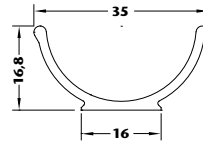

TS 35

- 01667 TS 35, 100 CM
- 17081 END TROUGH FOR TS 35, 50 CM, RIGHT
- 17080 END TROUGH FOR TS 35, 50 CM, LEFT
- 01670 PARTITION FOR TS 35

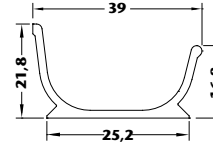

TS 36

- 02571 TS 36, 100 CM
- 17098 END TROUGH FOR TS 36, 50 CM, RIGHT
- 17099 END TROUGH FOR TS 36, 50 CM, LEFT
- 02605 PARTITION FOR TS 36

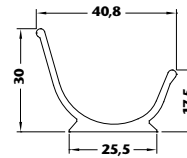

TS 41

- 03191 TS 41, 100 CM
- 01595 END TROUGH FOR TS 41, 100 CM
- 01596 END TROUGH FOR TS 41, 65 CM
- 03204 PARTITION FOR TS 41

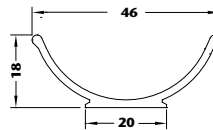

TS 35-50

- 09550 SINGLE TROUGH T35-50, CONCRETE ENCASING



FEED TABLES FOR CATTLE

- 09655 FEED TABLE, KL 60 L: 100 X H: 17 X B: 58 CM



POLYESTER GLUE

- 560435 POLYESTER GLUE 3 KG 150G PER JOINTS, 250G PER PARTITION
- 560308 ACO FUNKI COMPONENT FIX





DRY FEEDING

ACO FUNKI was one of the first to develop and start producing dry feeding systems.

The production dates all the way back to the mid 1960's, and ever since, the development has been ongoing, resulting in a strong and comprehensive dry feeding program.





DRY FEEDING SYSTEM

Easy inspection, uniform feed supply and reliability

Dry Feeding

MASTER CHAIN

SIZE (MM)	PULL	CAPACITY (KG/HR)
60	Chain	800
76	Chain	2000

POWERLINE

SIZE (MM)	PULL	CAPACITY (KG/HR)
60	Chain	800

- **Easy maintenance**
The front part is made of transparent plastic. Standard motor with few wear parts
- **Long durability**
V-belt drive = elastic, even pull with minimum wear
- **High security**
Emergency stop
- **Low energy consumption**
Powerful transmission with high efficiency and low ration, which at the same time prevents overheating
- **Adjustable feed pull out**
Prevents bridging
- **Optimal utility**
Adjustable dispensing, for both ground feed and pellets

CORNERS

- 0213-123 CORNER, FOR Ø60 MM SYSTEM
- 0213-200 CORNER, FOR Ø60 MM SYSTEM, STAINLESS STEEL
- 86186 CORNER, FOR Ø76 MM SYSTEM



CORNER WHEELS

- 0213-202 CORNER WHEEL, Ø60 MM, WITH SHAFT AND BEARINGS
- 86241 CORNER WHEEL, Ø76 MM, COMPLETE



FEED TUBES

- 0214-107 CONVEYOR TUBE Ø60 LENGTH 6 METER
- 0214-109 CONVEYOR TUBE STAINLESS STEEL Ø60 LENGTH 6 METER
- 86135 FEED TUBE 76 X 6000 MM, GALV. PRICE PER METER, LENGTH 6 METER



CONNECTION JOINTS

- 86100 CONNECTION JOINT, FOR Ø60 MM FEED TUBE, COMPLETE
- 86109 CONNECTION JOINT, FOR Ø60 MM FEED TUBE, COMPLETE, STAINLESS STEEL
- 86137 CONNECTION JOINT, FOR Ø76 MM FEED TUBE, COMPLETE



CONICAL DRILL

- 86148 CONICAL DRILL, FOR FEED TUBE Ø16 - 30,5 MM



DRY FEEDING SYSTEM



MASTER CHAIN® "ANTI TWIST"

- 0170-049 MASTER CHAIN 60 MM SMALL CHAIN DISK, PRICE PER METER, 50 METER, YELLOW
- 86087 CHAIN MASTER 76 MM ANTITWIST



POWERLINE® CHAIN

- 0117-225 POWERLINE CHAIN, FOR Ø60 MM



SWIVELS

- 0170-530 COMPLET SWIVEL
- 39408080 SWIVEL FOR POWERLINE CHAIN



JOINT LINKS

- 86029 JOINT LINK, FOR MASTER CHAIN



- 0117-205 JOINT LINK, FOR POWERLINE CHAIN



DRIVE UNIT

- 0211-830 MAXI DRIVE UNIT 60 MM POWERLINE
- 0211-825 MAXI DRIVE UNIT 76 MM
- 0211-820 MAXI DRIVE UNIT 60 MM

RECEPTION UNIT

- 0212-530 RECEPTION UNIT 60 MM
- 0212-540 RECEPTION UNIT 76 MM
- 0212-630 RECEPTION UNIT 60 MM STAINLESS STEEL
- 0212-640 RECEPTION UNIT 76 MM STAINLESS STEEL



Dry Feeding



SILO AND SUPPORT

Different types of steel silos to match most needs and support system that goes along the silo.



Silo

OVERVIEW OF STEEL SILO

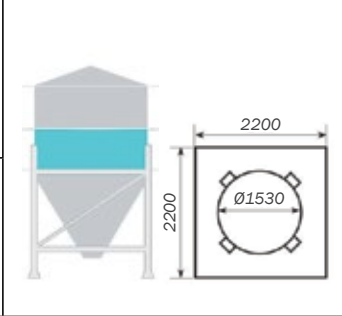
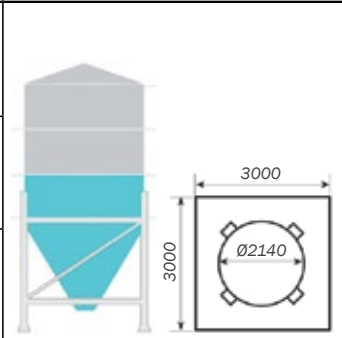
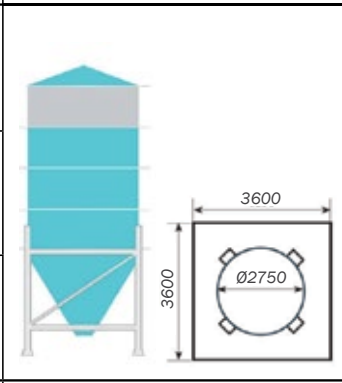
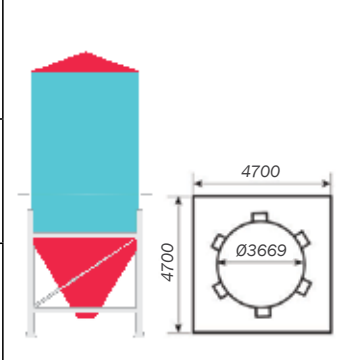
Model	Picture	No. of rings	No. of legs	Funnel	Volume (*) (T= m ³ /0,67)	Filling height (mech.)	Item no. (mech.)
ACF151		1	4	67°	2,70 m ³ / 1,81 T	3423 mm	567100
ACF152		2	4	67°	4,10 m ³ / 2,75 T	4239 mm	567101
ACF211		1	4	67°	6,40 m ³ / 4,29 T	4329 mm	567103
ACF212		2	4	67°	9,30 m ³ / 6,23 T	5145 mm	567104
ACF213		3	4	67°	12,20 m ³ / 8,17 T	5961 mm	567105
ACF272		2	6	60°	15,80 m ³ / 10,59 T	5308 mm	567107
ACF273		3	6	60°	20,60 m ³ / 13,80 T	6124 mm	567108
ACF274		4	6	60°	25,50 m ³ / 17,09 T	6968 mm	567109
ACF362		2	8	60°	32,10 m ³ / 21,51 T	6409 mm	567111
ACF363		3	8	60°	40,60 m ³ / 27,20 T	7225 mm	567112
ACF364		4	8	60°	49,10 m ³ / 32,90 T	8041 mm	567113

Sheet thickness

- 1 mm
- 1,2 mm
- 1,5 mm

(*) Calculator for feed: 0,67 t/m³

Silo with MECH loading system. Total height + 400mm

All silos min 860 mm from putlet to floor. Outlet Ø422

OVERVIEW OF STEEL SILO

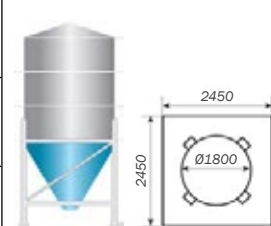
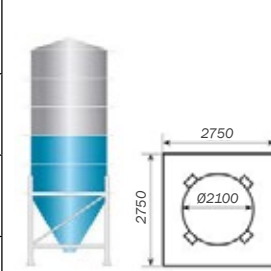
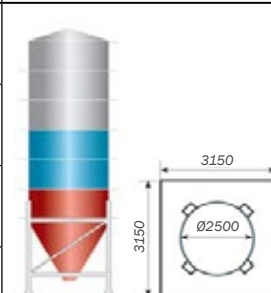
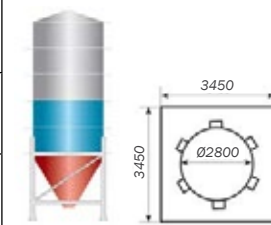
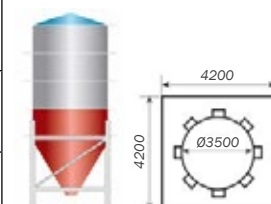
Model	Picture	No. of rings	No. of legs	Funnel	Volume (T= m ³ /0,67)	Item no. (pneum.)	Total height (pneum.) = Filling height (mech.)	Item no. (mech.)	Total height (mech.)
AF181		1	4	60°	4,20 m ³ / 2,80 T	567021	3367 mm	567022	4030 mm
AF182		2	4	60°	6,60 m ³ / 4,40 T	567023	4269 mm	567024	4932 mm
AF183		3	4	60°	9,00 m ³ / 6,00 T	567025	5171 mm	567026	5834 mm
AF212		2	4	60°	9,00 m ³ / 6,00 T	567031	4567 mm	567032	5072 mm
AF213		3	4	60°	12,10 m ³ / 8,10 T	567033	5469 mm	567034	5974 mm
AF214		4	4	60°	15,20 m ³ / 10,20 T	567035	6371 mm	567036	6876 mm
AF215		5	4	60°	18,30 m ³ / 12,30 T	567037	7273 mm	567038	7778 mm
AF253		3	4	60°	18,00 m ³ / 12,10 T	567041	5931 mm	567042	6318 mm
AF254		4	4	60°	22,40 m ³ / 15,00 T	567043	6833 mm	567044	7220 mm
AF255		5	4	60°	26,80 m ³ / 18,00 T	567045	7735 mm	567046	8122 mm
AF256		6	4	60°	31,20 m ³ / 20,90 T	567047	7273 mm	567048	9024 mm
AF284		4	6	60°	29,00 m ³ / 19,40 T	567051	7180 mm	567052	7466 mm
AF285		5	6	60°	34,60 m ³ / 23,20 T	567053	8082 mm	567054	8368 mm
AF286		6	6	60°	40,20 m ³ / 26,90 T	567055	8984 mm	567056	9270 mm
AF352		2	8	60°	30,30 m ³ / 20,30 T	567059	6175 mm	567060	7071 mm
AF253		3	8	60°	39,00 m ³ / 26,10 T	567061	7070 mm	567062	7973 mm
AF354		4	8	60°	47,70 m ³ / 32,00 T	567063	7979 mm	567064	8875 mm

Sheet thickness: 1 mm 1,2 mm 1,5 mm





SUPPORT SYSTEM

- 0146-470 FEED SUPPORT BOTTOM FOUNDATION SET
- 0146-475 FEED SUPPORT SYSTEM EXTENDER SET - VERTICALLY
- 0146-480 FEED SUPPORT SYSTEM HEIGHT 4.25 M LENGTH 5 METER
- 0146-485 FEED SUPPORT SYSTEM EXTENDER SET - HORIZONTALLY
- 0146-482 WIRE SET FOR FEED SUPPORT SYSTEM





WASHING ROBOT

Powerful, flexible and reliable washing robot

TECHNICAL SPECIFICATIONS

Dimensions (L x W x H)	115 x 69* x 145 cm
Weight	285 kg
Power supply	230 V
Required amperage	6 amp
Water consumption	Min. 20 /max. 40 l per minute
Maximum water pressure	200 Bar
Operating pressure	140 Bar (40 l water per minute)
Compressor	External

* Without side wheel



Service-friendly

ProCleaner X100 is designed to be particularly service friendly, and everything on the machine is easily accessible.

Efficient

ProCleaner X100 is a powerful wash robot with enough power for even the largest pig houses. In addition, it is extremely reliable.

User-adapted

If you have a variety of different pig houses or varying needs, ProCleaner X100 can be set and programmed according to your needs.

■ 99800020 WASH ROBOT PROCLEANER X100

SCAN QR CODE AND WATCH VIDEO ABOUT WASHING ROBOT



HERDING BOARDS



HERDING BOARDS

- 560410 HERDING BOARD 1210X770 MM



- 560470 HERDING BOARD 970X770 MM



- 560460 HERDING BOARD 460X770 MM



STRAW RACKS

- 2100641 STRAW HOLDER FOR FARROWING PEN, FIBER MATERIAL
10 LITER, 360 X 350 X 200 MM



- 4920526 STRAW HOLDER, FOR WEANERS AND FINISHERS, GALVANIZED
35 LITER, 88 X 514 X 205 MM



- 1920526 STRAW HOLDER, FOR SOWS, GALVANIZED
255 LITER, 1188 X 714 X 469 MM



HOLDER

- 4960518 HOLDER, FOR ROOTING MATERIALS, Ø125 MM, L=597 MM, PVC





FASTENERS

Bolts, screws, plugs, hinges, handles, holders, clamps, brackets, fittings...

- We carry all you need within fasteners for your farm equipment.

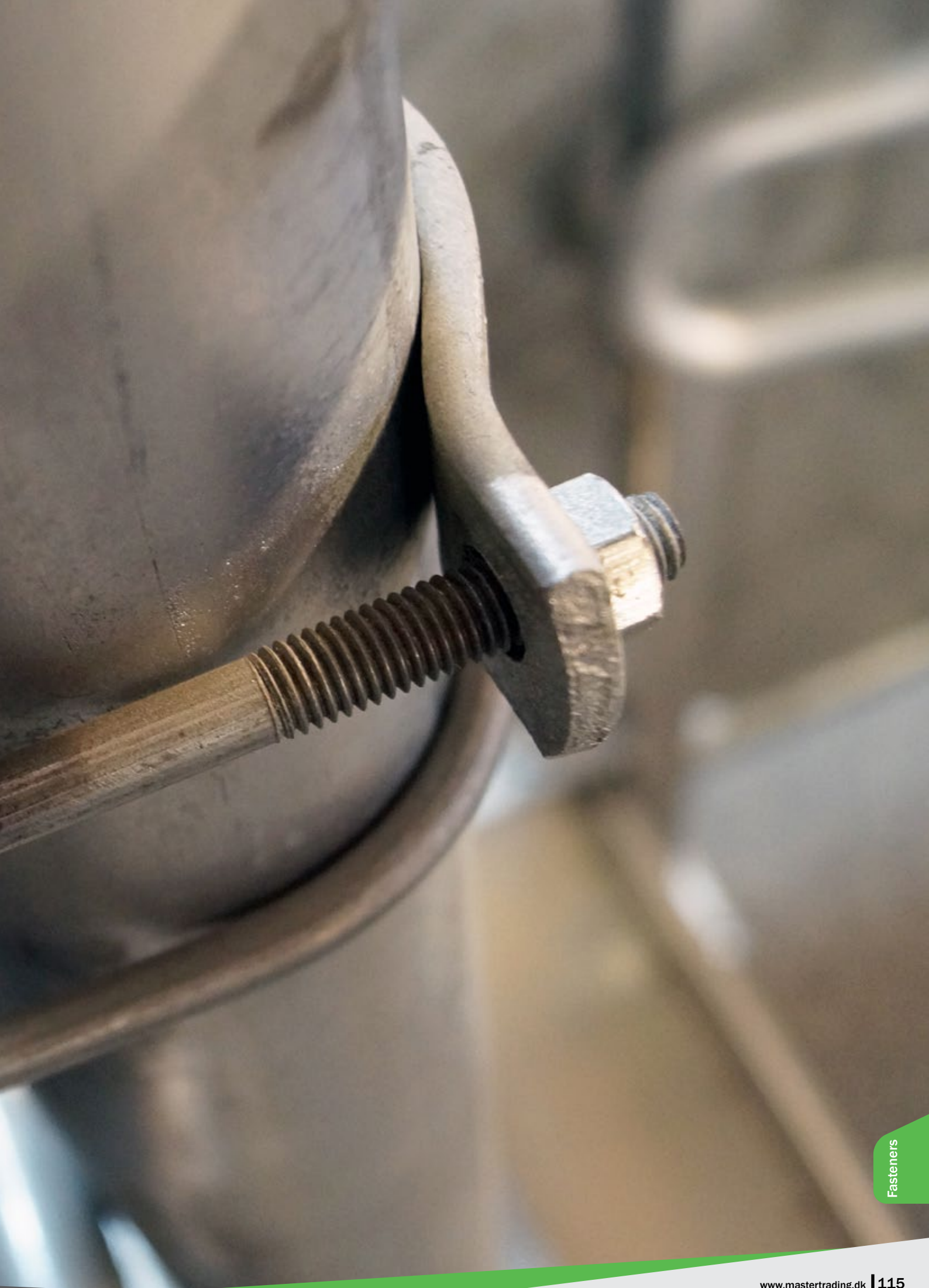



FASTENERS

A complete selection of fasteners to complement our equipment program

MATERIALS

Galvanized steel, stainless steel or strong plastic

- Bolts and anchors for flooring
- INN-O-PLUG for fastening of board profiles
- Retaining tools
- Clamps and brackets for water pipes - incl. MASTER CLAMP
- Hinges and handles
- Foot brackets and stabilisation posts

FIXINGS FOR CONCRETE SLATS

- 30871 T-ANCHOR FOR INN-O-PLUG, M10, 80-100 MM
- 30875 T-ANCHOR FOR INN-O-PLUG, M10, 100-120 MM

- 30872 BUTTON HEAD TORX 50, FOR T-ANCHOR, A2 BOLT, 10X90 MM
- 30310080 BUTTON HEAD TORX 50, M10X80 MM, STAINLESS STEEL

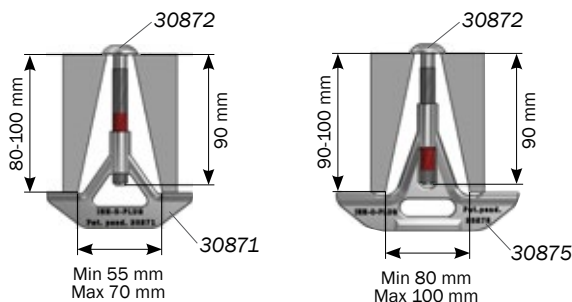

T-ANCHOR



TORX

- 90100079 DISPLACED T-BOLT, 50 MM



- 90100078 T-BOLT, M10, STAINLESS STEEL



- 30847 ANCHOR, FOR PLASTIC SLATS, M8
- 90130847 ANCHOR, FOR PLASTIC SLATS, M8

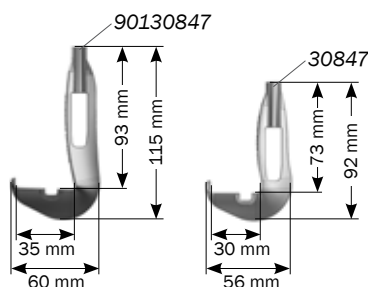

- 30887 INN-O-PLUG, M8 X 120, BH TX50 A2
- 30888 INN-O-PLUG, M8 X 90, BH TX50 A2 FT
- 30889 INN-O-PLUG, M8 X 65, BH TX50 A2 FT
- 560205 UN-EVENSIDED CONCRETE SLAT NYLON ANCHOR M10

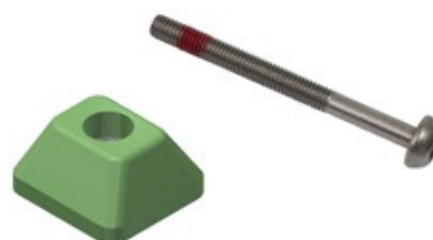

FASTENERS



- 30308071 BUTTONHEAD SCREW TORX 50, M8X70 MM, WITHOUT WASHER, STAINLESS STEEL



- 1900241 BOLT-ON FITTINGS, FOR CAST IRON SLATS, LARGE
- 96967 10 PCS BOLT-ON FITTINGS SMALL FOR CAST IRON SLATS



FIXINGS FOR PLASTIC SLATS

- 17095 SLAT ANCHOR, 8 MM, GREEN, 10 PCS./PACK
- 17129 SLAT ANCHOR, 10 MM, GREEN 10 PCS./PACK
- 1900515 SLAT ANCHOR 8 MM GREEN, 10 PIECES 30X35X9 MM EX. SCREWS



- 67442 COACH SCREW, TORX 50, 10X100 MM, STAINLESS STEEL
- 67444 BUTTON HEAD TORX 50, 10X70 MM, STAINLESS STEEL



- 39900000 WALL PLUG, 8X40 MM
- 39900001 WALL PLUG, 12X60 MM
- 39900120 WALL PLUG, 10X50 MM
- 9961004 WALL PLUG, 6X30 MM



INN-O-PLUG FOR PVC BOARD PROFILES

- 39106020 CONNECTION SCREW, TORX 30, M6X20, STAINLESS STEEL
- 39106030 CONNECTION SCREW, TORX 30, M6X30, STAINLESS STEEL
- 39106040 CONNECTION SCREW, TORX 30, M6X40, STAINLESS STEEL



- 39206037 SPLICING SLEEVE, TORX 30, M6X37, STAINLESS STEEL



- 4900466 CONNECTING SCREW SET, 39-48 MM, STAINLESS STEEL
- 4900467 CONNECTING SCREW SET, 44-58 MM, STAINLESS STEEL
- 4900468 CONNECTING SCREW SET, 49-68 MM, STAINLESS STEEL

U-CLAMPS

- 0211-705 U-CLAMP, FOR DOWNPIPE, Ø38 X 83 X M6, A2
- 0211-707 U-CLAMP, FOR DOWNPIPE, Ø43 X 88 X M6, A2
- 0211-709 U-CLAMP, FOR DOWNPIPE, Ø63 X 108 X M6, A2
- 1900109 U-BOLT 1" M8 WITH NUTS GALVANISED
- 1900199 U-BOLT 1" WITH NUTS



FORK FITTING

- 0139-119 FORK FITTING FOR 5/4' DOWNPIPE, 1' AND 5/4' PIPE
- 20014 PIPE CLAMP FITTING 1" X 1" WITH M8 STOPSCREW, GALVANIZED



WINDING CLAMPS

- 9930019 WINDING CLAMP, 1' X 5/4'
- 9930014 WINDING CLAMP, 1' X 1'



CLAMPS

- 0221-315 CLAMP, 3/4' X Ø80 MM, COMPLETE
- 0221-196 CLAMP, 1' X Ø80 MM, COMPLETE
- 0221-214 CLAMP, 1' X Ø96 MM, COMPLETE, ELECTRO GALVANIZED
- 0221-172 CLAMP, 5/4' X Ø80 MM, COMPLETE



MASTER CLAMP

- 20035 MASTER CLAMP WATER PIPE BRACKET, 1'



- 20045 MASTER CLAMP SPACER UNIT, 1'





- 20037 MASTER CLAMP WASHER, A2, Ø10,5 MM / Ø45 MM, 1,5 MM

DRILL CLAMPS



- 93205 DRILL CLAMP, MALE THREAD, 1/2' - 1', COMPLETE



- 93164 DRILL CLAMP, 1/2' - 1', STAINLESS STEEL



- 23961195 DRILL CLAMP, 10 MM - 32/33,7 MM, PVC
- 61195 DRILL CLAMP, 8 MM - 32/33,7 MM, PVC

ACCESSORIES FOR WATER PIPES



- 20007 WATER PIPE BRACKET 2, FOR 3 MM PIPE



- 8500532 WATER PIPE HOLDER, FOR 32 MM PVC PIPES
- 8500265 WATER PIPE HOLDER ON PLATE

PIPE HOLDERS

- 0234-100 PIPE HOLDER, FOR Ø75 MM PIPE
- 0221-193 PIPE HOLDER, FOR Ø80 MM PIPE
- 0221-221 PIPE HOLDER, FOR Ø96 MM PIPE
- 0146-061 PIPE HOLDER, FOR Ø90 MM PIPE
- 0146-115 PIPE HOLDER, FOR 5/4' PIPE



- 16375 PIPE RETAINER, 1', WITHOUT BOLT



HINGES - STAINLESS STEEL

- 4950463 HINGE FOR FOR Y- OR U-PROFILE, STAINLESS STEEL



- 4950465 HINGE FOR HAT PROFILE, STAINLESS STEEL



- 4950884 LOWER HINGE FOR GATE, RIGHT, STAINLESS STEEL
- 4950887 LOWER HINGE FOR GATE, LEFT, STAINLESS STEEL



HANDLES - STAINLESS STEEL

- 4910900 HANDLE, RIGHT, STAINLESS STEEL
- 4910889 HANDLE, LEFT, STAINLESS STEEL





HINGES - PLASTIC

- 8500153 LOWER HINGE FOR GATE, VERSION II



- 8500271 HINGE FOR HAT PROFILE, PVC



- 8500275 HINGE FOR FRONT PARTITION, PVC



HANDLES - PLASTIC

- 4110164 HANDLE FOR GATE, VERSION II, LEFT
- 4110163 HANDLE FOR GATE, VERSION II, RIGHT



STABILISATION POSTS

- 38910 STABILISATION POST, H58 CM
- 38909 STABILISATION POST, H77,4 CM
- 38916 STABILISATION POST, H100
- 4250545 STABILISATION POST H85 CM



- 30802 SINGLE FOOT BRACKET, FOR SLATS
- 30806 SINGLE FOOT BRACKET, FOR CONCRETE



FIND US ONLINE

Stay connected with Master Trading via our social media pages. It's a great way to interact with us, get your questions answered and make suggestions.

Follow Master Trading and check out the latest events



linkedin.com/company/master-trading/

Watch videos



youtube.com/@mastertrading_dk

Visit our website, and sign up for our product news



Sign up for our newsletter!
Scan the QR code or go to:
www.mastertrading.dk/news/newsletter

MASTER TRADING

Kirkevænget 5
7400 Herning, Denmark

+45 30 66 34 37
bd@mastertrading.dk
www.mastertrading.dk

