

# DRY FEEDING Feeders

Valid from 1 June 2023

MASTER TRADING

[www.mastertrading.dk](http://www.mastertrading.dk)



EUR



FunkiMat | TUBE-O-MAT | Combi Feeder | Baby Feeder | Box Feeder | CCM Feeder | Downpipes | Water Supply | Aqua Speed

MASTER  TRADING



## CONTENTS LIST

TUBE-O-MAT NX VI+ .....	4
TUBE-O-MAT NX CLASSIC .....	5
TURBOMAX .....	7
FUNKIMAT .....	8
DOUBLE FUNKIMAT .....	9
FUNKIMAT ACCESSORIES .....	10
COMBI FEEDER .....	11
BABY FEEDER .....	12
TUBE-O-MAT VI+ .....	13
TUBE-O-MAT CLASSIC .....	16
TUBE-O-MAT PIPE .....	18
TUBE-O-MAT TROUGH .....	19
TUBE-O-MAT AND TUBOMAX ACCESSORIES .....	19
3IN1 NX SPARE PART .....	20
BOX FEEDER - WEANERS .....	21
BOX FEEDER - FINISHERS .....	23
BOX FEEDER STAINLESS STEEL - WEANERS .....	24
BOX FEEDER STAINLESS STEEL - WTF .....	25
WET/DRY BOX FEEDER STAINLESS STEEL - WEANERS .....	27
WET/DRY BOX FEEDER STAINLESS STEEL - FINISHERS .....	27
CCM FEEDER .....	29
DOWNPIPE T-PIECE .....	29
DOWNPIPE SOLID PIECE .....	30
DOWNPIPE ACCESSORIES .....	31
DOWNPIPE SOLID PIECE - Ø75 MM OUTLET .....	32
TERMS OF SALES AND DELIVERY .....	33

## TUBE-O-MAT NX V+

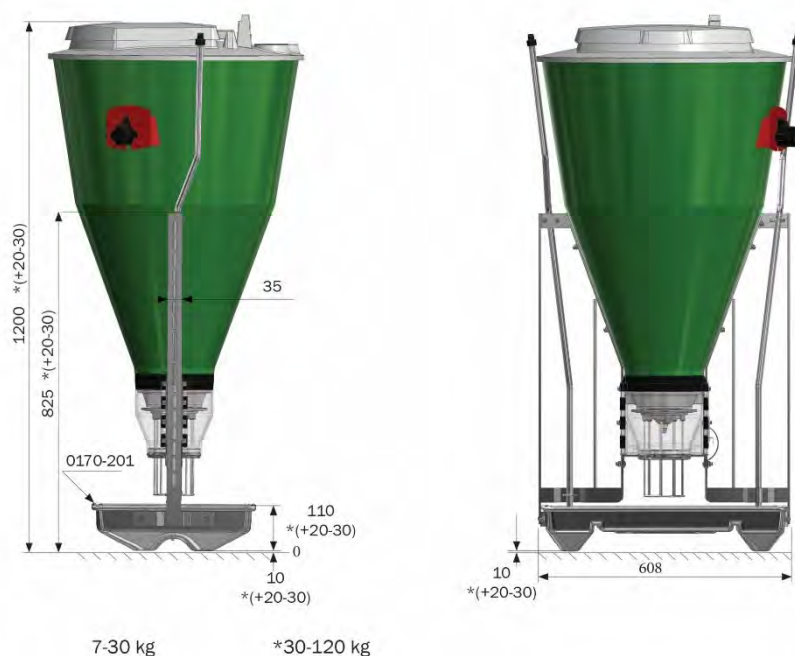

**560155M**

TUBE-O-MAT NX V+  
ASSEMBLED FEEDER

432,50€



**560155U**

TUBE-O-MAT NX V+  
UNASSEMBLED FEEDER

395,00€



**72391**

TUBE-O-MAT@ VIP/VI+ SPIRAL LARGE

4,00€

**72177**

TUBE-O-MAT@ VI+ PIN DOSING UNIT  
ACCESSORIES FOR FEEDERS

3,60€



**72175**

TUBE-O-MAT@ VI+ DOSING UNIT

55,20€



**70750**

BOTTOM FOR HOPPER VI+  
ACCESSORIES FOR FEEDERS

11,90€



**70752**  
TUBE-O-MAT® VI+ COVER PART VI+ TRANSPARE  
ACCESSORIES FOR FEEDERS

15,05€



**72181**  
TUBE-O-MAT® VI+ SLIDING LATCH \*A  
ACCESSORIES FOR FEEDERS

4,25€



**72367**  
TUBE-O-MAT® VIP/VI+ LIFTER COMPLETE

7,15€



**72371**  
TUBE-O-MAT® LIFTER/SPIRAL GUIDANCE 8MM

2,35€



**67104**  
M5 X 25 PAN HEAD SCREW PH DIN7985 A2

0,25€

## TUBE-O-MAT NX CLASSIC

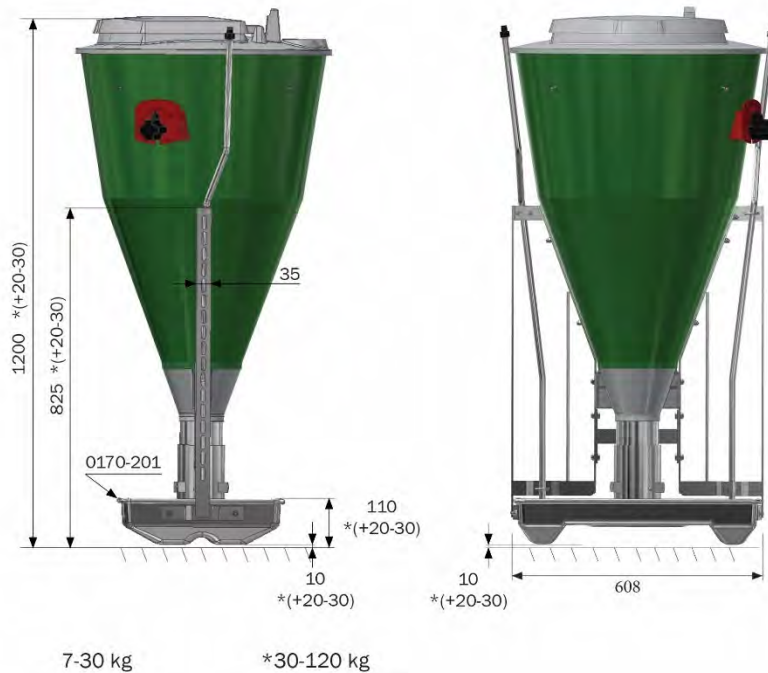











**560165M**  
TUBE-O-MAT NX CLASSIC  
ASSEMBLED FEEDER

401,50€



**560165U**  
TUBE-O-MAT NX CLASSIC  
UNASSEMBLED FEEDER

372,00€

	<b>72395</b> HELIX SMALL	3,80€
	<b>72371</b> TUBE-O-MAT® LIFTER/SPIRAL GUIDANCE 8MM	2,35€
	<b>72374</b> TUBE-O-MAT® TOP/PIGNIC ROTORHOVED U/LÅS	2,30€
	<b>67104</b> M5 X 25 PAN HEAD SCREW PH DIN7985 A2	0,25€
	<b>70745</b> PIG NIC COLLAR FOR TUBE-O-MAT CLASSIC ACCESSORIES FOR TUBE-O-MAT CLASSIC	30,75€
<b>TUBE-O-MAT NX Accessories</b>		
	<b>550580</b> HOPPER FOR 3IN1 NX 120 L	79,35€
	<b>550588</b> TOP FOR 3IN1 NX, WHITE	13,65€
	<b>550589</b> TOP LID 3IN1 NX, WHITE	9,70€
	<b>93245</b> PRESS NIPPLE TUBE-O-MAT® 3/8"INTERNAL THREAD	7,00€
	<b>18849</b> BRACING TOP, GALVANIZED ACCESSORIES FOR FEEDERS	8,20€
	<b>72316</b> TUBE-O-MAT® ADJUSTMENT HANDLE INCL. TURN ROD	15,75€

# TURBOMAX

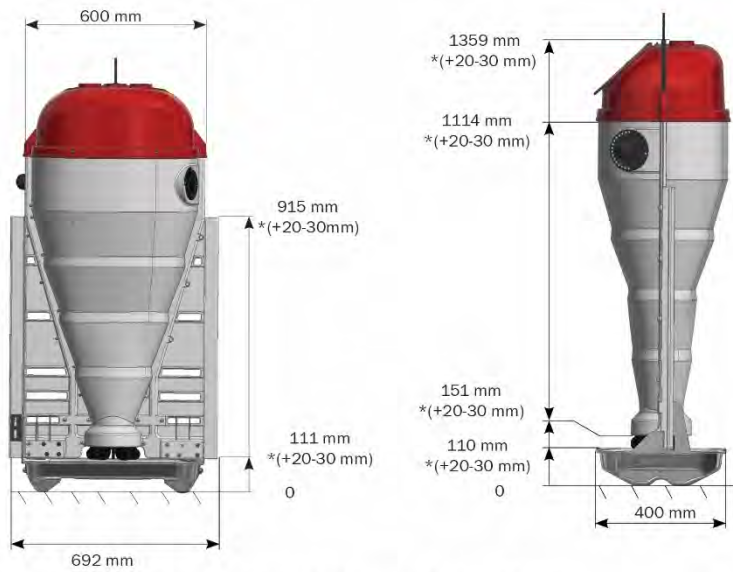

Measurements marked with \* apply to finishers (30-120 kg).  
Rest measurements apply to piglets (7-30 kg).



**560180M**

TURBOMAX FEEDER 7-30 KG  
ASSEMBLED FEEDER

392,50€



**560180U**

TURBOMAX FEEDER 7-30 KG  
UNASSEMBLED FEEDER

338,00€



**560185M**

TURBOMAX FEEDER 30-120 KG  
ASSEMBLED FEEDER

392,50€



**560185U**

TURBOMAX FEEDER 30-120 KG  
UNASSEMBLED FEEDER

338,00€



**0228-276**

STAINLESS STEEL POST FOR FEEDER

58,95€



**0228-231**

DRINKING VALVE SET FOR FEEDER

9,50€

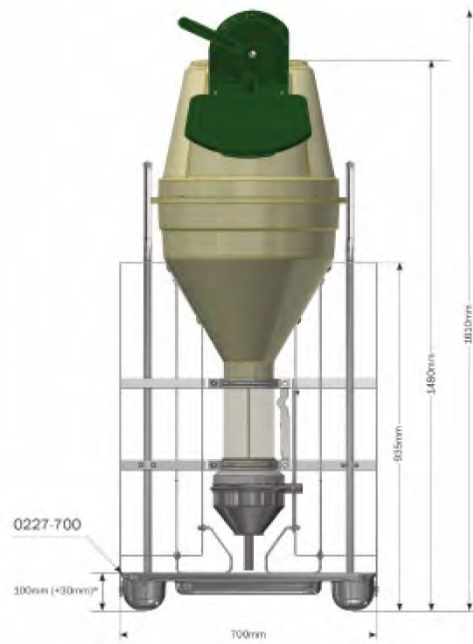

\*The height of 0227-701 trough for finisher is 130 mm



**560710M**

508,50€

FUNKIMAT WEANER WITH STAINLESS STEEL TROUGH (FLAT-FLAT)  
ASSEMBLED FEEDER



**560710U**

477,00€

FUNKIMAT WEANER WITH STAINLESS STEEL TROUGH (FLAT-FLAT)  
UNASSEMBLED FEEDER



**560711M**

513,50€

FUNKIMAT FINISHER WITH STAINLESS STEEL TROUGH (FLAT-FLAT)  
ASSEMBLED FEEDER



**560711U**

481,50€

FUNKIMAT FINISHER WITH STAINLESS STEEL TROUGH (FLAT-FLAT)  
UNASSEMBLED FEEDER



## Double Funkimat

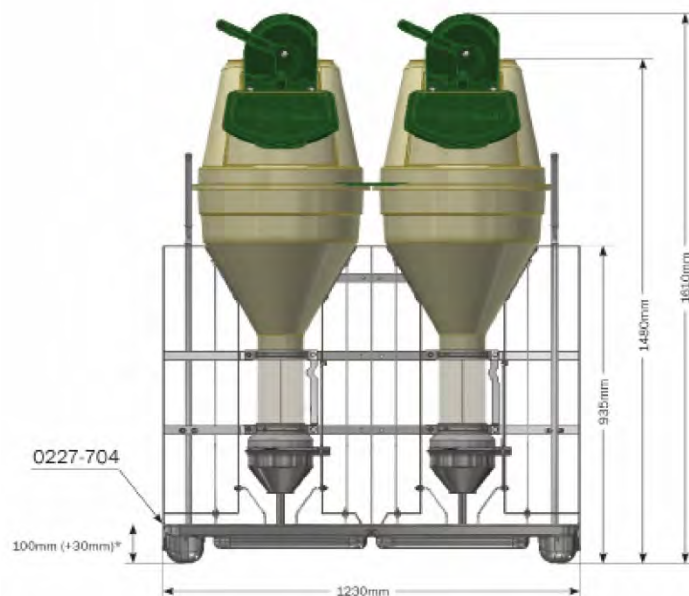

\*The height of 0227-705 trough for finisher is 130 mm



**0227-670**  
DOUBLE FUNKIMAT (FLAT-FLAT) - UNASSEMBLED

689,00€



**0227-714**  
ST TROUGH WEANER FOR DOUBLE FUNKIMAT, COMPLETE

149,00€



**0227-715**  
ST TROUGH FINISHER FOR DOUBLE FUNKIMAT, COMPLETE

149,50€



**0227-800**  
DOUBLE FUNKIMAT (FLAT-FLAT) WEANER MOUNTED

907,00€







**0227-900**  
DOUBLE FUNKIMAT (FLAT-FLAT) FINISHER - MOUNTED

908,00€



## Funkimat Accessories

	<b>0227-088</b> DOSAGE DISC VER. 3	13,60€
	<b>0227-309</b> DOSAGE DISC VER. 4 SMALL	13,60€
	<b>0227-370</b> RATAINER SPRING FOR DOSAGE DEVICE, STAINLESS STEEL FUNKIMAT VER. 2	9,00€
	<b>38524</b> MOUNTING KIT FOR U-POST AGAINST FEEDERS	7,55€
	<b>0227-440</b> DOSAGE DEVICE FOR FUNKIMAT, ASSEMBLED	279,50€
	<b>0227-438</b> LOWER STAINLESS FUNNEL VER. 3	126,00€
	<b>0227-319</b> CROSS FOR PREVENTING BLOCKINGOF FEED FOR FUNKIMAT AND 3IN1ROTO	44,30€
	<b>0227-558</b> FLOOR PLATE FOR DOUBLE FUNKIMAT AND 3N1 ROTO 10X1200X1200 MM LDPE STRUCTURE FOR UNDER FEEDERS	67,00€
	<b>0227-559</b> FLOOR PLATE FOR SINGLE FUNKIMAT AND 3IN1 ROTO 10X670X1200 MM LDPE STRUCTURE UNDER FEEDERS	44,85€
	<b>0228-276</b> STAINLESS STEEL POST FOR FEEDER	58,95€
	<b>0227-274</b> SOLID POST FOR FEED DISPENSER, 950MM	59,20€
	<b>0227-150</b> ST TROUGH FOOT ADJUSTABLE FOR FEEDER	32,50€

	<b>12100107</b> DRINKING VALVE 1/2" ST TYPE 13 DRINKING VALVE	7,45€
	<b>0227-580</b> WATER CONNECTING FOR SINGEL FEEDER 10 MM AQUASPEED WITH 1/2' OUTSIDE THREAD	19,50€
	<b>0227-587</b> HANGER FOR FEEDING PIPE	18,15€
	<b>0227-579</b> WATER CONNECTING FOR DOUBLE FEEDERS, 10MM AQUASPEED WITH 1/2' OUTSIDE THREAD	20,95€
	<b>0227-597</b> HANGER FOR FEEDING PIPE, DOUBLE FEEDERS	31,70€

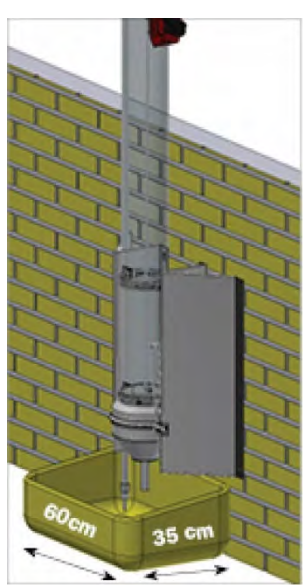
## Combi Feeder



	<b>0227-495</b> COMBI FEEDER COMPLETE	455,00€
	<b>0227-480</b> WATERPIPE FOR COMBI FEEDER	32,65€

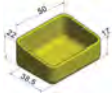

**09550**  
SINGLE TROUGH T35-50, FOR ENCASED IN CONCRETE

52,25€

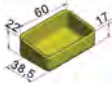

**09552**  
SINGLE TROUGH T35-60, FOR ENCASED IN CONCRETE

56,95€



**2750490**  
TROUGH FOR COMBI FEEDER, STAINLESS STEEL

117,00€

## Baby Feeder

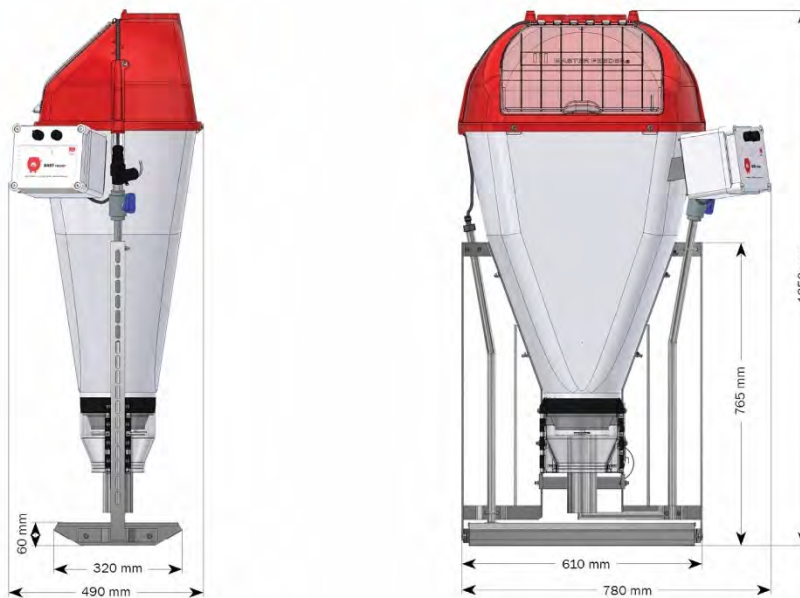

**0229-000**  
BABY FEEDER  
ASSEMBLED FEEDER

1912,50€



**0229-001**  
PLATE AND ACCESORIES FOR STAND-ALONE BABY FEEDER  
ACCESORIES TO BABY FEEDER

62,85€



**0229-034**  
DOSAGE DISC Ø129 LDPE  
ACCESSORIES FOR FEEDERS

9,70€



**0229-033**  
DOSAGE DISC Ø125 LDPE  
ACCESSORIES FOR FEEDERS

9,70€

72177

3,60€

TUBE-O-MAT® VI+ PIN DOSING UNIT  
ACCESSORIES FOR FEEDERS



70752

15,05€

TUBE-O-MAT® VI+ COVER PART VI+ TRANSPARE  
ACCESSORIES FOR FEEDERS



72181

4,25€

TUBE-O-MAT® VI+ SLIDING LATCH \*A  
ACCESSORIES FOR FEEDERS

## TUBE-O-MAT® VI+

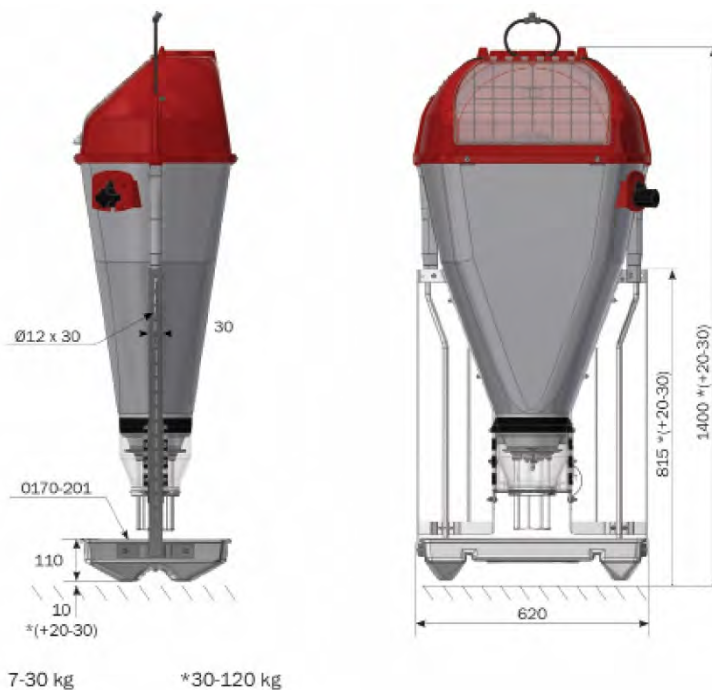

89550M

420,50€

TUBE-O-MAT® VI+ WTF  
ASSEMBLED FEEDER



89550U

384,00€

TUBE-O-MAT® VI+ WTF  
UNASSEMBLED FEEDER



89560M

389,00€

TUBE-O-MAT® VI+ FINISHER  
ASSEMBLED FEEDER



89560U

352,50€

TUBE-O-MAT® VI+ FINISHER  
UNASSEMBLED FEEDER

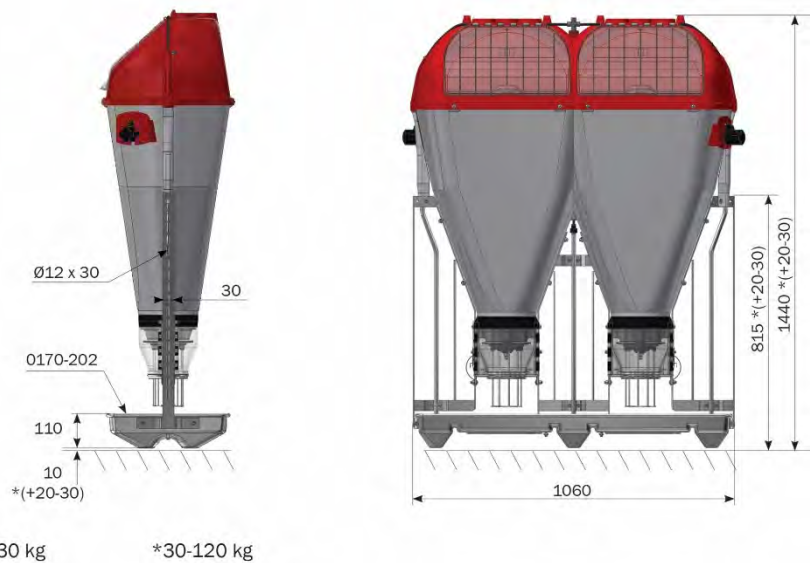

**89650M**

TUBE-O-MAT® VI+JUMBO WTF  
ASSEMBLED FEEDER

676,50€



**89650U**

TUBE-O-MAT® VI+ JUMBO WTF  
UNASSEMBLED FEEDER

585,50€



**89660M**

TUBE-O-MAT® VI+ JUMBO FINISHER  
ASSEMBLED FEEDER

676,50€



**89660U**

TUBE-O-MAT® VI+ JUMBO FINISHER  
UNASSEMBLED FEEDER

585,50€



**38524**

MOUNTING KIT FOR U-POST AGAINST FEEDERS

7,55€



**70711**

TUBE-O-MAT® HOPPER 2008  
ACCESSORIES FOR FEEDERS

80,85€



**70723**

TUBE-O-MAT® JUMBO HOPPER 2008

75,20€













**73710**

HATCH RED 0.8% UV TUBE-O-MAT® 2008





29,70€

ACCESSORIES FOR FEEDERS

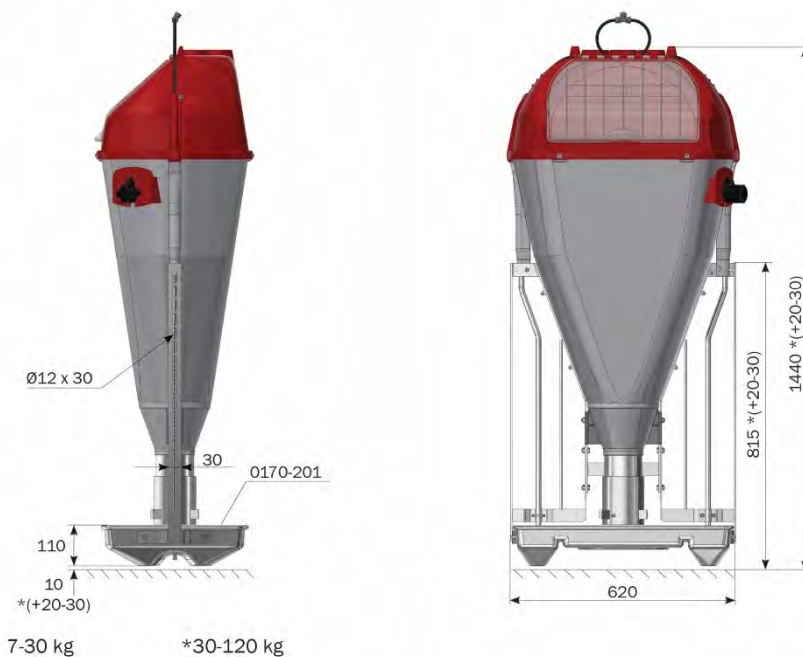
	<b>73720</b> TUBE-O-MAT® JUMBO 2008 LID PART FIXED ACCESSORIES FOR FEEDERS	46,60€
	<b>73700</b> LID PART HINGED TUBE-O-MAT® 2008 ACCESSORIES FOR FEEDERS	10,55€
	<b>73701</b> TUBE-O-MAT® 2008 HINGE PIN HATCH 2008 ACCESSORIES FOR FEEDERS	1,85€
	<b>72391</b> TUBE-O-MAT® VIP/VI+ SPIRAL LARGE ACCESSORIES FOR FEEDERS	4,00€
	<b>76262</b> MOUNTING KIT FEEDING PARTS FOR TUBE-O-MAT AND LTD VI+ ACCESSORIES FOR FEEDERS	128,00€
	<b>93245</b> PRESS NIPPLE TUBE-O-MAT® 3/8"INTERNAL THREAD ACCESSORIES FOR FEEDERS	7,00€
	<b>72177</b> TUBE-O-MAT® VI+ PIN DOSING UNIT ACCESSORIES FOR FEEDERS	3,60€
	<b>72175</b> TUBE-O-MAT® VI+ DOSING UNIT ACCESSORIES FOR FEEDERS	55,20€
	<b>70752</b> TUBE-O-MAT® VI+ COVER PART VI+ TRANSPARE ACCESSORIES FOR FEEDERS	15,05€
	<b>70750</b> BOTTOM FOR HOPPER VI+ ACCESSORIES FOR FEEDERS	11,90€
	<b>72181</b> TUBE-O-MAT® VI+ SLIDING LATCH *A ACCESSORIES FOR FEEDERS	4,25€

## TUBE-O-MAT® CLASSIC



	<b>89585M</b> TUBE-O-MAT® CLASSIC WTF ASSEMBLED FEEDER	398,00€
	<b>89585U</b> TUBE-O-MAT® CLASSIC WTF UNASSEMBLED FEEDER	361,50€
	<b>89587M</b> TUBE-O-MAT® CLASSIC FINISHER ASSEMBLED FEEDER	359,00€
	<b>89587U</b> TUBE-O-MAT® CLASSIC FINISHER UNASSEMBLED FEEDER	330,00€



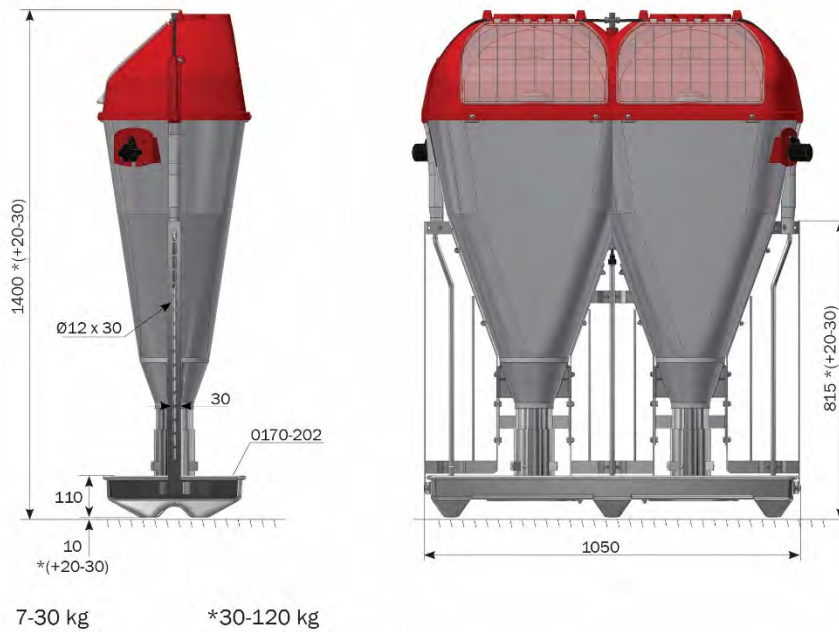

**89685M**

TUBE-O-MAT® CLASSIC JUMBO WTF  
ASSEMBLED FEEDER

622,50€



**89685U**

TUBE-O-MAT® CLASSIC JUMBO WTF  
UNASSEMBLED FEEDER

540,50€



**89687M**

TUBE-O-MAT® CLASSIC JUMBO FINISHER  
ASSEMBLED FEEDER

622,50€



**89687U**

TUBE-O-MAT® CLASSIC JUMBO FINISHER  
UNASSEMBLED FEEDER

540,50€



**38524**

MOUNTING KIT FOR U-POST AGAINST FEEDERS

7,55€



**70711**

TUBE-O-MAT® HOPPER 2008  
ACCESSORIES FOR FEEDERS

80,85€



**70723**

TUBE-O-MAT® JUMBO HOPPER 2008

75,20€



**73710**

HATCH RED 0.8% UV TUBE-O-MAT® 2008  
ACCESSORIES FOR FEEDERS

29,70€



**73720**  
TUBE-O-MAT® JUMBO 2008 LID PART FIXED

46,60€



**73700**  
LID PART HINGED TUBE-O-MAT® 2008  
ACCESSORIES FOR FEEDERS

10,55€



**73701**  
TUBE-O-MAT® 2008 HINGE PIN HATCH 2008  
ACCESSORIES FOR FEEDERS

1,85€



**72395**  
HELIX SMALL

3,80€



**76275**  
MOUNTING KIT FEEDING PARTS FOR TUBE-O-MAT AND LTD CLASSIC

90,35€



**93245**  
PRESS NIPPLE TUBE-O-MAT® 3/8"INTERNAL THREAD

7,00€



**70745**  
PIG NIC COLLAR FOR TUBE-O-MAT CLASSIC  
ACCESSORIES FOR TUBE-O-MAT CLASSIC

30,75€

## TUBE-O-MAT® PIPE

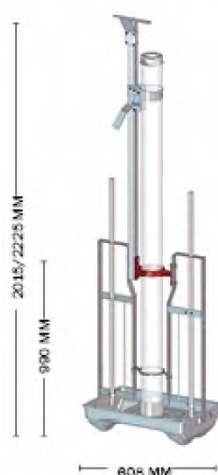

**89504M**  
TUBE-O-MAT® TUBE FINISHER  
ASSEMBLED FEEDER

570,50€

	<b>89504U</b> TUBE-O-MAT® TUBE FINISHER UNASSEMBLED FEEDER	547,50€
---	--	---------

	<b>89684M</b> TUBE-O-MAT® TUBE JUMBO FINISHER ASSEMBLED FEEDER	1021,00€
---	--	----------

	<b>89684U</b> TUBE-O-MAT® TUBE JUMBO FINISHER UNASSEMBLED FEEDER	957,50€
---	--	---------

## TUBE-O-MAT Trough

	<b>71008</b> TROUGH VI+ WTF, 11 X 40 X 60 CM	68,10€
---	---	--------

	<b>71009</b> TROUGH VI+ AND TUBE FINISHERS, 15 X 40 X 60 CM	62,30€
---	--	--------

	<b>71029</b> TROUGH CLASSIC WTF, 11 X 40 X 60 CM ACCESSORIES FOR FEEDERS	93,70€
--	--	--------

	<b>71030</b> TROUGH CLASSIC FINISHER, 15 X 40 X 60 CM	74,90€
---	--	--------













	<b>0170-201</b> SINGLE TROUGH TOM V+ AND CLASSIC WTF 11X40X60 CM	61,35€
---	---	--------

	<b>0170-202</b> DOUBLE TROUGH TOM V+ AND CLASSIC 11X40X103 CM	88,75€
---	--	--------

## TUBE-O-MAT AND TUBOMAX Accessories

	<b>74501</b> FOOT BRACKET 16/18 CM - FINISHER TUBE-O-MAT®	11,50€
---	--	--------

	<b>74502</b> FOOT BRACKET 12/18 CM - WTF TUBE-O-MAT®	9,55€
---	---	-------

	<b>74503</b> FOOT BRACKET 16/25 CM - FINISHER TUBE-O-MAT®	20,15€
	<b>74504</b> FOOT BRACKETS 12/25 CM - WTF	13,70€
	<b>89014</b> FLOOR PLATE FOR SINGLE TUBE-O-MAT 10X608X1200 MM LDPE STRUCTURE UNDER FEEDERS	49,40€
	<b>89016</b> FLOOR PLATE FOR DOUBLE TUBE-O-MAT 10X1040X1200 MM LDPE STRUCTURE UNDER FEEDERS	75,05€
<b>3IN1 NX spare part</b>		
	<b>550580</b> HOPPER FOR 3IN1 NX 120 L	79,35€
	<b>550588</b> TOP FOR 3IN1 NX, WHITE	13,65€
	<b>550589</b> TOP LID 3IN1 NX, WHITE	9,70€
	<b>560597</b> ACCESSORIES BOX, 3IN1 NX VERS. 2	168,00€
	<b>18724</b> THREE-LEG, 3-IN-1 PLASTIC HOPPER, 96 CM	51,05€
	<b>550599</b> BOTTOM HOPPER FOR 3IN1 FEEDER	6,35€
	<b>281523</b> FEEDING PIPE 3IN1 WITH PLASTIC COLLAR	71,85€
	<b>18723</b> FEEDINGTUBE, WITH STAINLESS STEEL COLLAR FOR 3IN1 FEEDER	114,00€

	<b>18848</b> GUIDE RING STAINLESS STEEL FOR 3IN1 NX	67,15€
---	--	--------

	<b>18846</b> RECEPTION RING FOR HOPPER 3IN1	8,55€
---	--	-------

	<b>18614</b> FITTING FOR LIMITED ACCESS TO FEED FOR 3IN1 FEEDER, INCL. FASTENING SCREWS	51,95€
---	--	--------

	<b>281490</b> PRESS NIPPLE 3IN1 SS 1/2" EXT.TREAD	10,00€
---	--	--------

	<b>281496</b> PRESS NIPPLE SS FOR TOM PIPE FEEDER 1/2' EXTERNAL THREAD	5,95€
---	---	-------

### Rare spare parts

	<b>281518</b> SLIDING ELEMENT FOR 3IN1 NX	1,70€
---	--	-------

	<b>72395</b> HELIX SMALL	3,80€
---	-----------------------------	-------













### Box feeder - Weaners

	<b>560042M</b> BOX FEEDERS WEANERS 2X1 SS TROUGH 41,5X74X31 CM ASSEMBLED ASSEMBLED FEEDER	194,50€
---	---	---------

	<b>560042U</b> BOX FEEDERS WEANERS 2X1 SS TROUGH 41,5X74X31 CM UNASSEMBLED UNASSEMBLED FEEDER	188,50€
---	---	---------

	<b>560043M</b> BOX FEEDERS WEANERS 3X1 SS TROUGH 61,5X74X31 CM ASSEMBLED ASSEMBLED FEEDER	237,00€
---	---	---------

	<b>560043U</b> BOX FEEDERS WEANERS 3X1 SS TROUGH 61,5X74X31 CM UNASSEMBLED UNASSEMBLED FEEDER	228,00€
---	---	---------

	<b>560044M</b> BOX FEEDERS WEANERS 4X1 SS TROUGH 81,5X74X31 CM ASSEMBLED ASSEMBLED FEEDER	292,00€
	<b>560044U</b> BOX FEEDERS WEANERS 4X1 SS TROUGH 81,5X74X31 CM UNASSEMBLED UNASSEMBLED FEEDER	283,00€
	<b>560045M</b> BOX FEEDERS WEANERS 5X1 SS TROUGH 101,5X74X31 CM ASSEMBLED ASSEMBLED FEEDER	340,50€
	<b>560045U</b> BOX FEEDERS WEANERS 5X1 SS TROUGH 101,5X74X31 CM UNASSEMBLED UNASSEMBLED FEEDER	328,50€
	<b>560046M</b> BOX FEEDERS WEANERS 6X1 SS TROUGH 121,5X74X31 CM ASSEMBLED ASSEMBLED FEEDER	386,00€
	<b>560046U</b> BOX FEEDERS WEANERS 6X1 SS TROUGH 121,5X74X31 CM UNASSEMBLED UNASSEMBLED FEEDER	377,00€
	<b>560052M</b> BOX FEEDERS WEANERS 2X2 SS TROUGH 41,5X74X62 CM ASSEMBLED ASSEMBLED FEEDER	313,00€
	<b>560052U</b> BOX FEEDERS WEANERS 2X2 SS TROUGH 41,5X74X62 CM UNASSEMBLED UNASSEMBLED FEEDER	322,50€
	<b>560053M</b> BOX FEEDERS WEANERS 3X2 SS TROUGH 61,5X74X62 CM ASSEMBLED ASSEMBLED FEEDER	398,00€
	<b>560053U</b> BOX FEEDERS WEANERS 3X2 SS TROUGH 61,5X74X62 CM UNASSEMBLED UNASSEMBLED FEEDER	377,00€
	<b>560054M</b> BOX FEEDERS WEANERS 4X2 SS TROUGH 81,5X74X62 CM ASSEMBLED ASSEMBLED FEEDER	483,00€
	<b>560054U</b> BOX FEEDERS WEANERS 4X2 SS TROUGH 81,5X74X62 CM UNASSEMBLED UNASSEMBLED FEEDER	468,00€
	<b>560055M</b> BOX FEEDERS WEANERS 5X2 SS TROUGH 101,5X74X62 CM ASSEMBLED ASSEMBLED FEEDER	544,00€

	<b>560055U</b> BOX FEEDERS WEANERS 5X2 SS TROUGH 101,5X74X62 CM UNASSEMBLED UNASSEMBLED FEEDER	526,00€
---	--	---------

	<b>560056M</b> BOX FEEDERS WEANERS 6X2 SS TROUGH 121,5X74X62 CM ASSEMBLED ASSEMBLED FEEDER	623,00€
---	--	---------

	<b>560056U</b> BOX FEEDERS WEANERS 6X2 SS TROUGH 121,5X74X62 CM UNASSEMBLED UNASSEMBLED FEEDER	601,50€
---	--	---------

### Box feeder - Finisher

	<b>560062M</b> BOX FEEDERS FINISHER 2X1 SS TROUGH 61,5X99X39 CM ASSEMBLED ASSEMBLED FEEDER	289,00€
---	--	---------

	<b>560062U</b> BOX FEEDERS FINISHER 2X1 SS TROUGH 61,5X99X39 CM UNASSEMBLED UNASSEMBLED FEEDER	283,00€
---	--	---------

	<b>560063M</b> BOX FEEDERS FINISHER 3X1 SS TROUGH 91,5X99X39 CM ASSEMBLED ASSEMBLED FEEDER	398,00€
--	--	---------

	<b>560063U</b> BOX FEEDERS FINISHER 3X1 SS TROUGH 91,5X99X39 CM UNASSEMBLED UNASSEMBLED FEEDER	368,00€
---	--	---------







	<b>560064M</b> BOX FEEDERS FINISHER 4X1 SS TROUGH 120,5X99X39 CM ASSEMBLED ASSEMBLED FEEDER	468,00€
---	---	---------

	<b>560064U</b> BOX FEEDERS FINISHER 4X1 SS TROUGH 120,5X99X39 CM UNASSEMBLED UNASSEMBLED FEEDER	453,00€
---	---	---------

	<b>560065M</b> BOX FEEDERS FINISHER 5X1 SS TROUGH 151,5X99X39 CM ASSEMBLED ASSEMBLED FEEDER	516,50€
---	---	---------

	<b>560065U</b> BOX FEEDERS FINISHER 5X1 SS TROUGH 151,5X99X39 CM UNASSEMBLED UNASSEMBLED FEEDER	513,50€
---	---	---------









	<b>560072M</b> BOX FEEDERS FINISHER 2X2 SS TROUGH 61,5X99X80 CM ASSEMBLED ASSEMBLED FEEDER	443,50€
---	--	---------

	<b>560072U</b> BOX FEEDERS FINISHER 2X2 SS TROUGH 61,5X99X80 CM UNASSEMBLED UNASSEMBLED FEEDER	425,50€
	<b>560073M</b> BOX FEEDERS FINISHER 3X2 SS TROUGH 91,5X99X80 CM ASSEMBLED ASSEMBLED FEEDER	568,50€
	<b>560073U</b> BOX FEEDERS FINISHER 3X2 SS TROUGH 91,5X99X80 CM UNASSEMBLED UNASSEMBLED FEEDER	617,00€
	<b>560074M</b> BOX FEEDERS FINISHER 4X2 SS TROUGH 120,5X99X80 CM ASSEMBLED ASSEMBLED FEEDER	768,50€
	<b>560074U</b> BOX FEEDERS FINISHER 4X2 SS TROUGH 120,5X99X80 CM UNASSEMBLED UNASSEMBLED FEEDER	671,50€
	<b>560075M</b> BOX FEEDERS FINISHER 5X2 SS TROUGH 151,5X99X80 CM ASSEMBLED ASSEMBLED FEEDER	832,50€
	<b>560075U</b> BOX FEEDERS FINISHER 5X2 SS TROUGH 151,5X99X80 CM UNASSEMBLED UNASSEMBLED FEEDER	765,50€

### Box feeder Stainless steel - Weaners

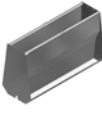
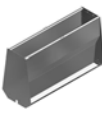



	<b>560355M</b> BOX FEEDERS WEANERS 1X4 STAINLESS STEEL 80X29X70 CM ASSEMBLED	374,00€
	<b>560355U</b> BOX FEEDERS WEANERS 1X4 STAINLESS STEEL 80X29X70 CM UNASSEMBLED	324,50€
	<b>560356M</b> BOX FEEDERS WEANERS 1X6 STAINLESS STEEL 120X29X70 CM ASSEMBLED	446,50€
	<b>560356U</b> BOX FEEDERS WEANERS 1X6 STAINLESS STEEL 120X29X70 CM UNASSEMBLED	397,00€
	<b>560357M *</b> BOX FEEDERS WEANERS 1X8 STAINLESS STEEL 160X29X70 CM ASSEMBLED	552,50€

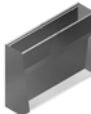
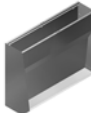
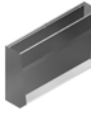
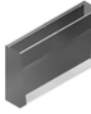

	<b>560357U *</b> BOX FEEDERS WEANERS 1X8 STAINLESS STEEL 160X29X70 CM UNASSEMBLED	503,00€
	<b>560358 *</b> DOWN PIPE SUPPORT SINGLE WEANER FEEDER	4,90€
	<b>560359 *</b> 1" STAINLESS STEEL PIPE INCL U-CLAMP AND NUTS SINGLE WEANER FEEDER	7,95€
	<b>560360M</b> BOX FEEDERS WEANERS 2X4 STAINLESS STEEL 80X47X70 CM ASSEMBLED	459,50€
	<b>560360U</b> BOX FEEDERS WEANERS 2X4 STAINLESS STEEL 80X47X70 CM UNASSEMBLED	410,50€
	<b>560361M *</b> BOX FEEDERS WEANERS 2X6 STAINLESS STEEL 120X47X70 CM ASSEMBLED	585,00€
	<b>560361U *</b> BOX FEEDERS WEANERS 2X6 STAINLESS STEEL 120X47X70 CM UNASSEMBLED	535,50€
	<b>560362M *</b> BOX FEEDERS WEANERS 2X8 STAINLESS STEEL 160X47X70 CM ASSEMBLED	719,00€
	<b>560362U *</b> BOX FEEDERS WEANERS 2X8 STAINLESS STEEL 160X47X70 CM UNASSEMBLED	669,50€
	<b>560363 *</b> DOWN PIPE SUPPORT DOUBLE WEANER FEEDER	5,35€
	<b>560364 *</b> 1" STAINLESS STEEL PIPE INCL U-CLAMP AND NUTS DOUBLE WEANER FEEDER	9,50€

### Box feeder Stainless steel - WTF

	<b>560365M</b> BOX FEEDERS WTF 1X3 STAINLESS STEEL 90X40,8X90 CM ASSEMBLED	471,50€
---	--	---------

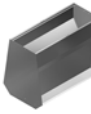
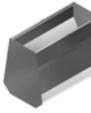
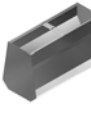
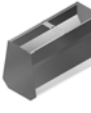
	<b>560365U</b> BOX FEEDERS WTF 1X3 STAINLESS STEEL 90X40,8X90 CM UNASSEMBLED	422,00€
	<b>560366M *</b> BOX FEEDERS WTF 1X4 STAINLESS STEEL 120X40,8X90 CM ASSEMBLED	550,50€
	<b>560366U *</b> BOX FEEDERS WTF 1X4 STAINLESS STEEL 120X40,8X90 CM UNASSEMBLED	501,00€
	<b>560367M</b> BOX FEEDERS WTF 1X5 STAINLESS STEEL 150X40,8X90 CM ASSEMBLED	626,00€
	<b>560367U</b> BOX FEEDERS WTF 1X5 STAINLESS STEEL 150X40,8X90 CM UNASSEMBLED	577,00€
	<b>560368 *</b> DOWN PIPE SUPPORT SINGLE WTF FEEDER	5,85€
	<b>560369 *</b> 1" STAINLESS STEEL PIPE INCL U-CLAMP AND NUTS SINGLE WTF FEEDER	9,50€
	<b>560370M</b> BOX FEEDERS WTF 2X3 STAINLESS STEEL 90X73,5X90 CM ASSEMBLED	624,50€
	<b>560370U</b> BOX FEEDERS WTF 2X3 STAINLESS STEEL 90X73,5X90 CM UNASSEMBLED	575,00€
	<b>560371M *</b> BOX FEEDERS WTF 2X4 STAINLESS STEEL 120X73,5X90 CM ASSEMBLED	730,00€
	<b>560371U *</b> BOX FEEDERS WTF 2X4 STAINLESS STEEL 120X73,5X90 CM UNASSEMBLED	680,50€
	<b>560372M *</b> BOX FEEDERS WTF 2X5 STAINLESS STEEL 150X73,5X90 CM ASSEMBLED	832,00€
	<b>560372U *</b> BOX FEEDERS WTF 2X5 STAINLESS STEEL 150X73,5X90 CM UNASSEMBLED	782,50€

	<b>560373 *</b> DOWN PIPE SUPPORT DOUBLE WTF FEEDER	6,85€
---	--	-------

	<b>560374 *</b> 1" STAINLESS STEEL PIPE INCL U-CLAMP AND NUTS DOUBLE WTF FEEDER	12,65€
---	--	--------

### WET/DRY Box feeder Stainless steel - Weaners

	<b>560375M *</b> WET/DRY BOX FEEDERS WEANERS 2X4 STAINLESS STEEL 98X39,5X70 CM ASSEMBLED	640,00€
---	--	---------

	<b>560375U *</b> WET/DRY BOX FEEDERS WEANERS 2X4 STAINLESS STEEL 98X39,5X70 CM UNASSEMBLED	566,00€
---	--	---------

	<b>560376M *</b> WET/DRY BOX FEEDERS WEANERS 2X5 STAINLESS STEEL 122,5X39,5X70 CM ASSEMBLED	732,00€
---	---	---------

	<b>560376U *</b> WET/DRY BOX FEEDERS WEANERS 2X5 STAINLESS STEEL 122,5X39,5X70 CM UNASSEMBLED	658,00€
--	---	---------

	<b>560377M *</b> WET/DRY BOX FEEDERS WEANERS 2X6 STAINLESS STEEL 147X39,5X70 CM ASSEMBLED	795,50€
---	---	---------

	<b>560377U *</b> WET/DRY BOX FEEDERS WEANERS 2X6 STAINLESS STEEL 147X39,5X70 CM UNASSEMBLED	721,50€
---	---	---------

	<b>560378 *</b> DOWN PIPE SUPPORT WET/DRY WEANER FEEDER Ø75 INCL. 2 SCREWS AND NUTS	6,35€
---	--	-------

	<b>560379 *</b> 1" STAINLESS STEEL PIPE INCL U-CLAMP AND NUTS WET/DRY WEANER FEEDER BOX FEEDER	10,65€
---	--	--------

### WET/DRY Box feeder Stainless steel - Finisher

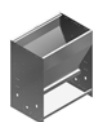
	<b>560380M *</b> WET/DRY BOX FEEDERS FINISHER 2X2 STAINLESS STEEL 76X51,5X90 CM ASSEMBLED	652,00€
---	---	---------

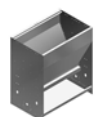





	<b>560380U *</b> WET/DRY BOX FEEDERS FINISHER 2X2 STAINLESS STEEL 76X51,5X90 CM	578,00€
---	--	---------

UNASSEMBLED



	<b>560381 *</b> WEAN-TO-FINISH REDUCTIONS ADAPTER 2X2 BOX FEEDER	31,70€
	<b>560382M *</b> WET/DRY BOX FEEDERS FINISHER 2X3 STAINLESS STEEL 114X51,5X90 CM	797,50€
	<b>560382U *</b> WET/DRY BOX FEEDERS FINISHER 2X3 STAINLESS STEEL 114X51,5X90 CM UNASSEMBLED	723,50€
	<b>560383 *</b> WEAN-TO-FINISH REDUCTIONS ADAPTER 2X3 BOX FEEDER	60,70€
	<b>560384M *</b> WET/DRY BOX FEEDERS FINISHER 2X4 STAINLESS STEEL 152X51,5X90 CM ASSEMBLED	944,00€
	<b>560384U *</b> WET/DRY BOX FEEDERS FINISHER 2X4 STAINLESS STEEL 152X51,5X90 CM UNASSEMBLED	870,00€
	<b>560385 *</b> WEAN-TO-FINISH REDUCTIONS ADAPTER 2X4 BOX FEEDER	50,65€
	<b>560386M *</b> WET/DRY BOX FEEDERS FINISHER 2X5 STAINLESS STEEL 190X51,5X90 CM ASSEMBLED	1088,00€
	<b>560386U *</b> WET/DRY BOX FEEDERS FINISHER 2X5 STAINLESS STEEL 190X51,5X90 CM UNASSEMBLED	1014,00€
	<b>560387 *</b> WEAN-TO-FINISH REDUCTIONS ADAPTER 2X5 BOX FEEDER	40,95€

### Accessories Box feeder Stainless steel













	<b>560388 *</b> DOWN PIPE SUPPORT WET/DRY FINISHER, WTF FEEDER Ø75 INCL. 2 SCREWS AND NUTS BOX FEEDER	7,95€
---	--	-------













	<b>560389 *</b>	12,80€
	1" STAINLESS STEEL PIPE INCL U-CLAMP AND NUTS WET/DRY WTF FEEDER BOX FEEDER	
	<b>560390 *</b>	13,25€
	WATERPIPE L990 MM FOR BOX FEEDER WITH WATER BOX FEEDER	
	<b>560391 *</b>	13,60€
	MOUNTING KIT WET/DRY FEEDER SINGLE SIDE BOX FEEDER	
	<b>560392</b>	5,45€
	MOUNTING KIT DRY FEEDER SINGLE SIDE BOX FEEDER	
	<b>560393</b>	4,80€
	MOUNTING KIT SINGLE FEEDER (AGAINST BOARD PROFILE AND PANEL) BOX FEEDER	
	<b>560394</b>	14,90€
	FLOOR MOUNTING KIT SINGEL SIDE BOX FEEDER	
	<b>560397</b>	6,85€
	MOUNTING KIT WTF SINGLE FEEDER (AGAINST PLATE/TOP PIPE) BOX FEEDER	
	<b>560398</b>	4,40€
	MOUNTING KIT SINGLE FEEDER (AGAINST PLATE) BOX FEEDER	
	<b>560399</b>	4,70€
	MOUNTING KIT SINGLE FEEDER (AGAINST WALL) BOX FEEDER	

## CCM Feeder





	<b>18746</b>	1059,00€
	CCM MAXI TYPE II (71 L)) TROU W/DOME, FINISHERS 25-115 KG, 30-40 ANIMALS/FEEDER	
	<b>18090</b>	736,00€
	CCM FEEDER MINI 40L WEANER 5-35 KG, 30-40 PER FEEDER, TROUGH Ø50/10CM HIGH	

## Downpipe T-Piece

	<b>0227-591</b> FEED DOWNPIPE Ø63X1000 INCLUDING Ø38 T-PIECE ACCESSORIES FOR FEEDERS	9,70€
	<b>0227-592</b> FEED DOWNPIPE Ø63X1000 INCLUDING Ø60 T-PIECE ACCESSORIES FOR FEEDERS	8,90€
	<b>0227-593</b> FEED DOWNPIPE Ø63X3000 INCLUDING Ø38 T-PIECE ACCESSORIES FOR FEEDERS	17,90€
	<b>0227-594</b> FEED DOWNPIPE Ø63X3000 INCLUDING Ø60 T-PIECE ACCESSORIES FOR FEEDERS	17,05€
	<b>0142-015</b> T-PIECE WITH SLIDE, Ø38 DRYFEEDING PIPE	8,30€
	<b>0232-010</b> T-PIECE WITH SLIDE, Ø60 ACCESSORIES FOR FEEDING PIPES	8,50€
	<b>0232-009</b> SLIDE (BLACK) ACCESSORIES FOR FEEDING PIPES	2,05€
	<b>0232-007</b> SLIDE FOR T-PIECE ACCESSORIES FOR FEEDING PIPES	1,95€
<b>Downpipe Solid Piece</b>		
	<b>90550</b> FEED DOWNPIPE 38 MM WITH FIXED T-PIECE FEED PIPES	15,05€
	<b>90552</b> FEED DOWNPIPE 50 MM WITH FIXED T-PIECE FEED PIPES	15,75€
	<b>90554</b> FEED DOWNPIPE 60 MM WITH FIXED T-PIECE FEED PIPES	17,45€
	<b>90571</b> FEED DOWNPIPE 38 MM Y- MODEL WITH FIXED T-PIECE FEED PIPES	32,90€

	<b>90573</b> FEED DOWNPIPE 50 MM Y-MODEL WITH FIXED T-PIECE FEED PIPES	33,60€
	<b>90574</b> FEED DOWNPIPE 60 MM Y-MODEL WITH FIXED T-PIECE FEED PIPES	35,35€
	<b>90560</b> FEED DOWNPIPE 38 MM WITH FIXED T-PIECE FOR TUBE FEEDER FEED PIPES	10,30€
	<b>90562</b> FEED DOWNPIPE 50 MM WITH FIXED T-PIECE FOR TUBE FEEDER FEED PIPES	10,90€
	<b>90564</b> FEED DOWNPIPE 60 MM WITH FIXED T-PIECE FOR TUBE FEEDER FEED PIPES	12,65€
	<b>90482</b> FIXED T-PIECE FOR 38 MM ACCESSORIES FOR FEEDING PIPES	5,00€
	<b>90484</b> FIXED T-PIECE FOR 50 MM ACCESSORIES FOR FEEDING PIPES	5,60€
	<b>90486</b> FIXED T-PIECE FOR 60 MM ACCESSORIES FOR FEEDING PIPES	7,35€
<b>Downpipe Solid Accessories</b>		
	<b>0228-595</b> TELESCOP WITH DOWNPIPE	15,75€
	<b>0228-588</b> DOWNPIPE Ø63X2 1000 MM WITH HOLE DRYFEEDING PIPE	10,15€
	<b>90268</b> MASTER COLLAR, PLASTIC, FOR DOWN PIPE ACCESSORIES FOR FEEDING PIPES	1,50€
	<b>90212</b> Y-BRANCH 63 MM 30° ACCESSORIES FOR FEEDING PIPES	8,50€

## Downpipe Solid Piece - Ø75 MM Outlet

	<b>0228-488</b> FIXED T-PIECE 76 MM ACCESSORIES FOR FEEDING PIPES	8,75€
	<b>90249</b> PLASTIC DOWN TUBE 75 SPEC. LENGTH	Ask for price
	<b>0228-480</b> TELESCOP PIPE Ø80 ACCESSORIES FOR FEEDING PIPES	15,45€
	<b>0228-510</b> Y-PIECE 75 MM 60° ACCESSORIES FOR FEEDING PIPES	6,75€



## ACO FUNKI A/S general terms of sales and delivery

This price list is valid from the 1st of Juni 2023 and replaces all previously published price lists. All prices are gross prices excluding VAT and are subject to the following general sales and delivery terms.

ACO FUNKI A/S is not liable for misprints or product and price changes.

The sales and delivery terms stated below are valid unless a written agreement of derogation is signed between ACO FUNKI A/S and Buyer.

### Drawings and product information

Drawings, wording in quotes, illustrations, technical specifications and other product information etc. are guiding and without any obligation or liability. ACO FUNKI A/S is not liable for any errors, misinterpretations, notices or laws etc.

Project material (drawings, illustrations, quotes etc.) are the property of ACO FUNKI A/S and can not be handed over to other parties without the written consent of ACO FUNKI A/S. If this requirement is not met, ACO FUNKI A/S reserves the right to invoice its internal costs.

### Quotes

Quotes are made subject to prior sale and validity of quotes. Quotes specifically state validity. ACO FUNKI A/S reserves the right to withdraw any quote without any prior notice.

### Prices

All prices are excluding VAT and based on all known taxes and material costs at the time of quote submission. ACO FUNKI A/S reserves the right to price regulations due to changes in taxes or material costs.

### Payment terms

8 days net. Buyer is not justified to set off any claims in payments without prior written consent of ACO FUNKI A/S. Overdue payments are subject to 1.5% interest per commenced month. ACO FUNKI A/S reserves the right to require a payment guarantee at any time.

### Handling fee

Orders amounting to less than 536 Euros are subject to a handling fee of 27 Euros.

### Delivery terms

EXW Herring - according to Incoterms 2020. (ACO FUNKI A/S has taken out transport insurance on all deliveries, notwithstanding delivery condition.)

### Time of delivery

Our time of delivery is according to agreement between Buyer and ACO FUNKI A/S.

### Packing materials

The packaging fees are subject to changes in the daily price and can be changed without notice. Currently, pallets are invoiced at 17 Euros each, and transport frames 17 Euros each. (Return is not possible due to risk of infection.)

### Return of goods

Return goods are only accepted according to prior and specific agreement between Buyer and ACO FUNKI A/S. ACO FUNKI A/S only accepts return of unused, non-damaged standard goods, which have never been installed. Return goods must be in original packing. Return goods will be credited at 80% of the items' net price.

If ACO FUNKI A/S is project liable all excess items after project completion are the property of ACO FUNKI A/S.

## Other terms

### Mounting

Mounting is not included in quotes from ACO FUNKI A/S, unless otherwise clearly stated in the order confirmation. The same applies to all electric/construction and foundation work.

Mounting is only performed at a fixed price if the mounting site is empty, cleaned up and in an already prepared condition. It is the responsibility of the Buyer to place the material closest possible to the mounting site and to ensure an acceptable accessibility of the mounting site, in accordance with the assessment of Service and Mounting department.

If mounting coincides with other on site work performed by third party, mounting is carried out at an hourly payment rate.

ACO FUNKI A/S reserves the right to change the agreed price on projects with fixed mounting price, if the Service and mounting department does not find the mounting site properly prepared. ACO FUNKI A/S also reserves the right to invoice additional time spent on any in vain driving, wages, site cleaning, removal of goods etc.

Self-supporting cast iron, concrete slats and polymer troughs are never included in the mounting prices, except when otherwise specifically stated in the order confirmation.

All water installations end by the end of the row or on the inside of the section, except when otherwise specifically stated in the order confirmation.

When Buyer self is responsible for mounting, all adjustments to the equipment are at own risk (pipes, board profiles etc.) regardless of any acquired supervision from ACO FUNKI A/S.

Self-supporting cast iron

Due to production method fluctuations in dimensions and sizes may occur. As a result, the product may be uneven.

None of these fluctuations are of any significant importance to the product functionality. Cast iron slats are only intended for pigs and should not be exposed to any other strain.

### General information

Colour difference may generally occur in the products, especially products produced of miscellaneous types of PVC/ plastic/fiber material.

The buyer holds the responsibility of storing the purchased goods under a roof so that the goods are not exposed to frost, water and direct sunlight.

Any damage as a result of incorrect storage as well as damage during transport at the place of delivery is the responsibility of the buyer.

All types of water valves are designed for a working pressure of 2.5-3.0 bar. It is the buyer's responsibility to measure and possibly regulate the water pressure.

ACO FUNKI A/S does not accept complaints on water valves used at a working pressure above 3 bar.

When extra deliveries of goods or services are requested due to alleged lacks, ACO FUNKI A/S reserves the right to invoice the goods' value as well as any other additional costs, in case a previous delivery has been made or the alleged lacks are groundless.

ACO FUNKI A/S disclaims complaint liability if any acid has been added to water/feed without prior accept. ACO FUNKI A/S also disclaims liability if the concrete indoor climate, does not meet with the standards of good indoor climate.

The description of goods should only be considered as guiding and is subject to errors. Therefore the component list is valid for the quote. If the component list is not attached to the quote, it is imposed on the Buyer to obtain it.

For all other conditions regarding deliveries excluding installation, NL92 applies, except for the last sentence of point No. 11 as well as points Nos. 13 and 14.



# MASTER TRADING



[webshop-acofunki.aco.com](http://webshop-acofunki.aco.com)



**Bjørn Dalsgaard  
Johannesen**  
Tel.: +45 30 66 34 37  
[bd@mastertrading.dk](mailto:bd@mastertrading.dk)



**Jan Therkildsen**  
Tel.: +45 2153 5668  
[jt@mastertrading.dk](mailto:jt@mastertrading.dk)



**Tino Holger Ulshöfer**  
Tel.: +49 4331 664 66 90  
[tino.ulshoefer@aco.com](mailto:tino.ulshoefer@aco.com)

**MASTER TRADING**  
[www.mastertrading.dk](http://www.mastertrading.dk)

Kirkevænget 5  
7400 Heming  
Denmark



*MASTER TRADING's product program is trendsetting within modern pig production, and the company's great values are: usability in the stable, animal welfare, design, optimal logistics and competitive prices.*