

MASTER : TRADING

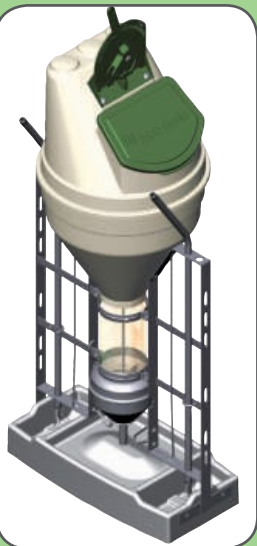

COMPONENT CATALOGUE



ANIMAL WELFARE • FUNCTION & DESIGN • LOGISTICS • COMPETITIVE PRICES • QUALITY

MASTER TRADING is a company, specializing in components for modern pig production.

MASTER TRADING's product program is trendsetting within modern pig production, and the company's great values are:

- Usability in the stall
- Animal welfare
- Design
- Optimal logistics
- Competitive prices

MASTER TRADING's office located in Herning, Denmark, where you also can visit our *SHOWROOM* and see the wide range of our products. Without any commitment you can see, feel and try out the differences and functions and thereby choose the solution that matches exactly your needs. You can, of course, also get the professional guidance from our experienced sales consultants.



MASTER TRADING • Kirkevænget 5 • DK-7400 Herning • T. +45 9744 6677 • www.mastertrading.dk

YOU ARE WELCOME TO CONTACT US



Jan Therkildsen
Sales Manager
M. +45 21 53 56 68
jt@mastertrading.dk



Claes Petersen
Key Account Manager
M. +45 29 60 65 49
cp@mastertrading.dk



Bjørn Dalsgaard
Sales back-up
T. +45 30 66 34 37
bd@mastertrading.dk

FEEDERS

- TUBE-O-MAT® VI+ and CLASSIC4
- TUBE-O-MAT® LTD8
- TUBE-O-MAT® TUBE 12
- FUNKIMAT® 14
- Accessories for feeders17
- Feed bowls..... 21

DRIK-O-MAT® DRINKING CUPS 22

DRINKING NIPPLES..... 24

MASTER CLAMP® WATER PIPE BRACKETS 25

FARROWING PEN

- INN-O-CRATE® FARROWING CRATE 27
- INN-O-CORNER® PIGLET NEST 28
- FUNKI F207 FARROWING CRATE..... 30

COMBI-FLOOR

- Cast iron slats for COMBI-FLOOR 32
- Plastic slats for COMBI-FLOOR 33
- Support and accessories..... 34
- Accessories for plastic slats 35
- Polymer plate and heating plates 36
- Comfort Plate polymer plate..... 37

SELF-SUPPORTING CAST IRON SLATS 38

PVC BOARD PROFILES 40

FUNKI FLEX® PENNING EQUIPMENT 43

FLEXCOVER® CLIMATE COVER 45

STAINLESS STEEL TROUGHS 48

SOW TROUGH IN STAINLESS STEEL..... 51

POLYMER TROUGHS AND FEED TABLES 52

‘BIOLINE CORNER’ - CORNER TROUGH FOR SOWS 57

DRY FEEDING SYSTEM 58

‘MASTER VALVE SOW’ - FEED DISPENSER WITH INTEGRATED FEED VALVE..... 62

‘MASTER VALVE DRY’ - PNEUMATIC VALVE 63

FEED DISPENSERS AND FEED OUTLETS 64

FASTENING 70



TUBE-O-MAT® VI+ AND CLASSIC

Feeders for weaners, Wean-to-Finish and finishers

VOLUME

Hopper 83 l / approx. 58 kg
Hopper Jumbo 160 l / approx. 112 kg

CAPACITY PER TROUGH

Weaners up to 30 kg: 30-50 pigs
Wean-to-Finish 7-120 kg: 30-50 pigs
Jumbo: 50-70 pigs
Finishers 18-120 kg: 30-50 pigs
Jumbo: 50-70 pigs

FRAME

TUBE-O-MAT® is delivered with frame of 4 mm stainless steel

WATER SUPPLY

3/8" stainless steel pipe, external thread
Adjustable press nipple, stainless steel, article 93245

The optimum feeder:

- Lid with 3 feed inlets ensures a correct filling
- The arched dust repellent shape of the lid ensures a maximum space utilization
- The opening part of the lid is made of transparent material and is located low in order to make manual filling and inspection easy
- Almost vertical sides prevent bridging
- Water supply via flexible PE-hoses ensures a constant water supply and easy mounting



VI+ WEAN-TO-FINISH TROUGH

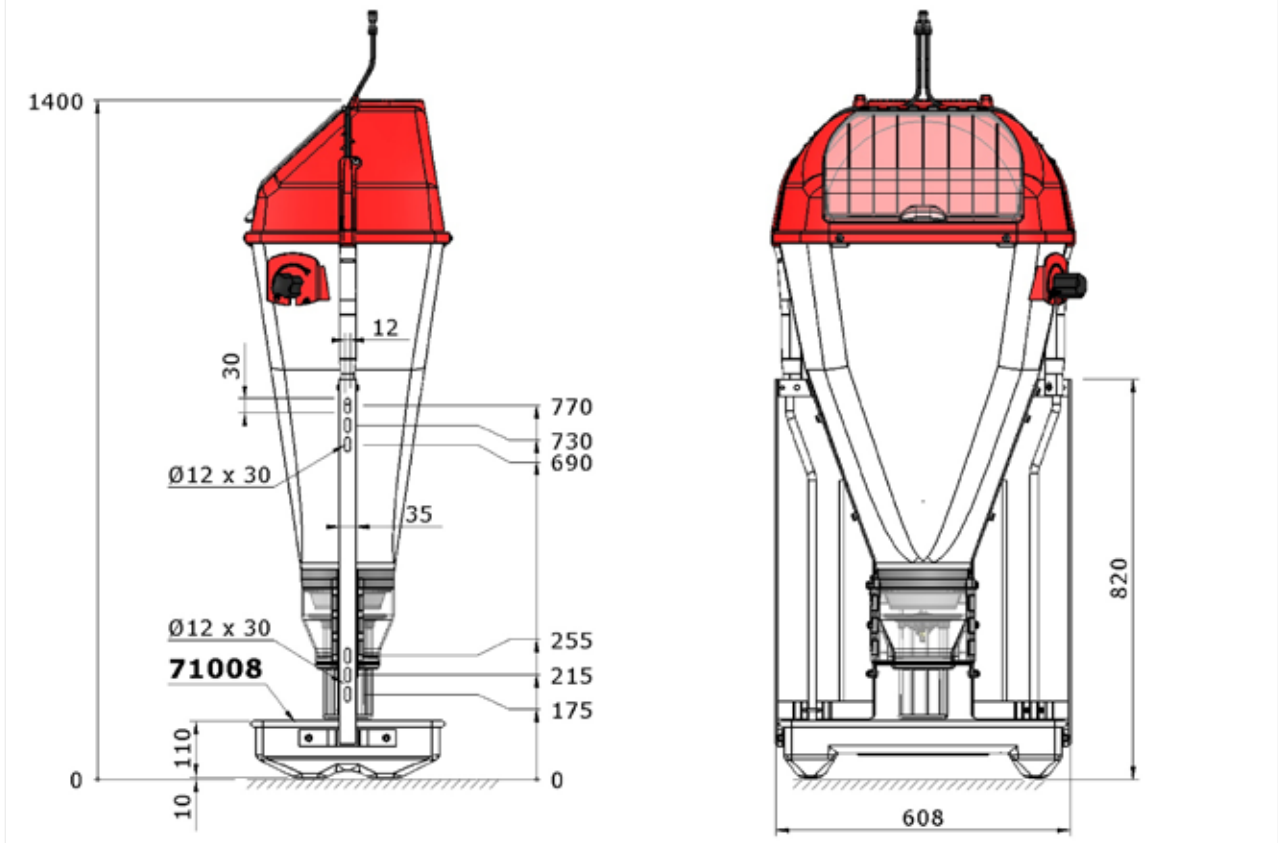

VI+ JUMBO ANGLE STEEL, FINISHERS TROUGH

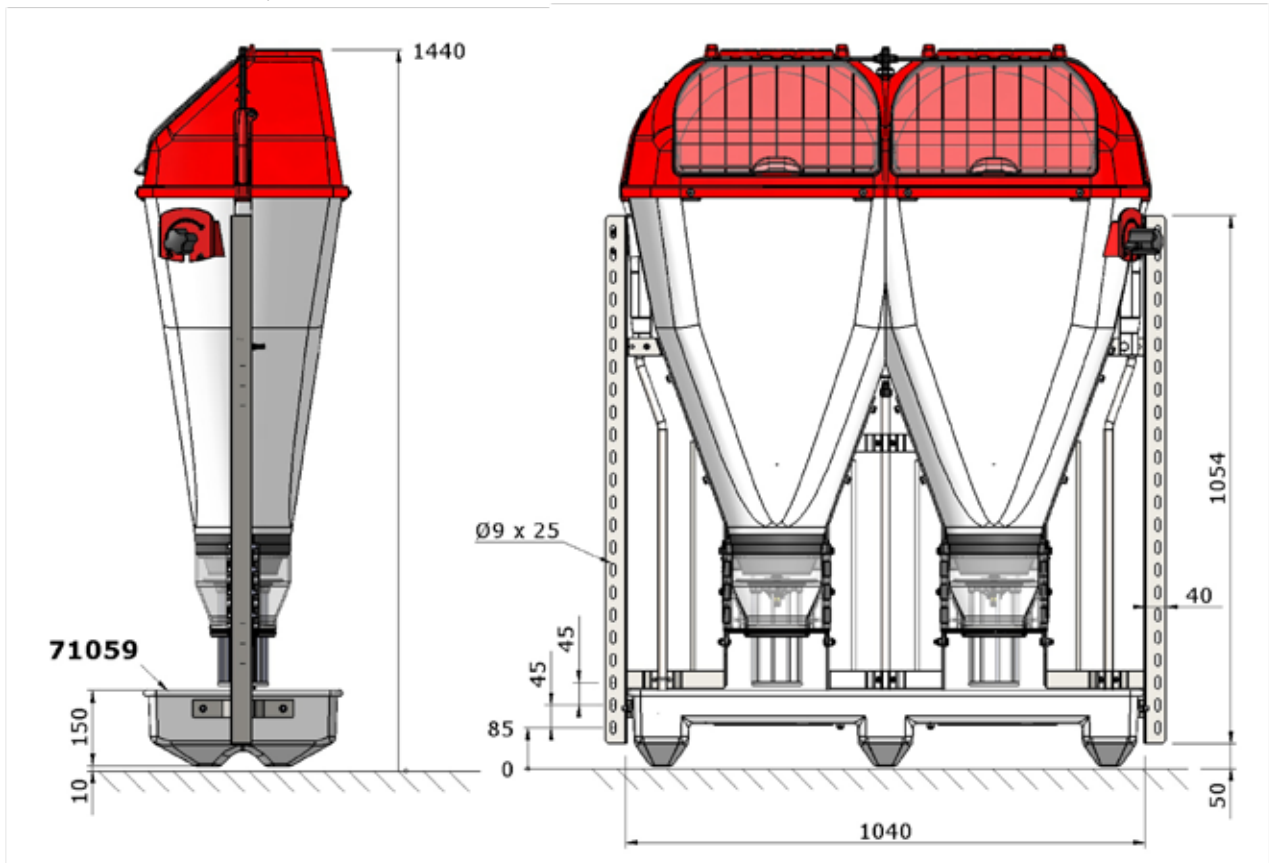

CLASSIC ANGLE STEEL, FINISHERS TROUGH

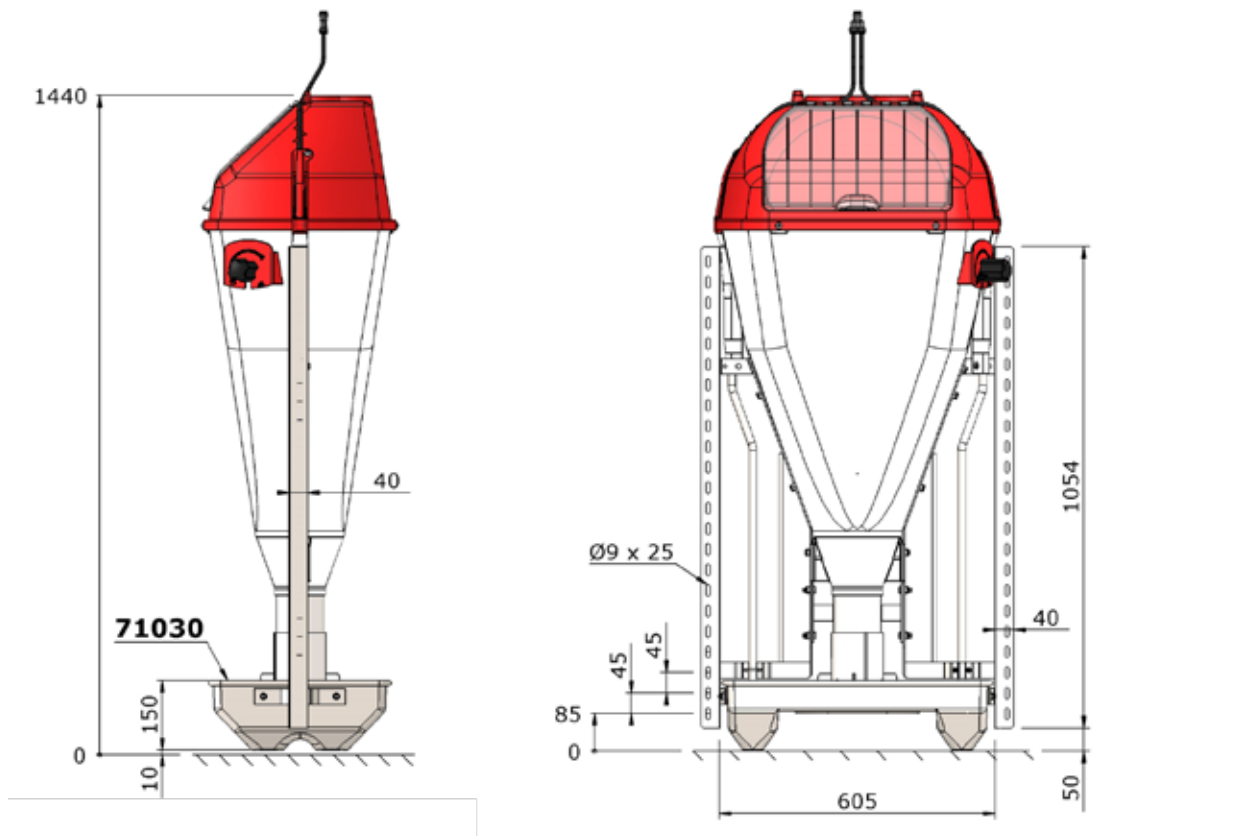

CLASSIC JUMBO FINISHERS TROUGH

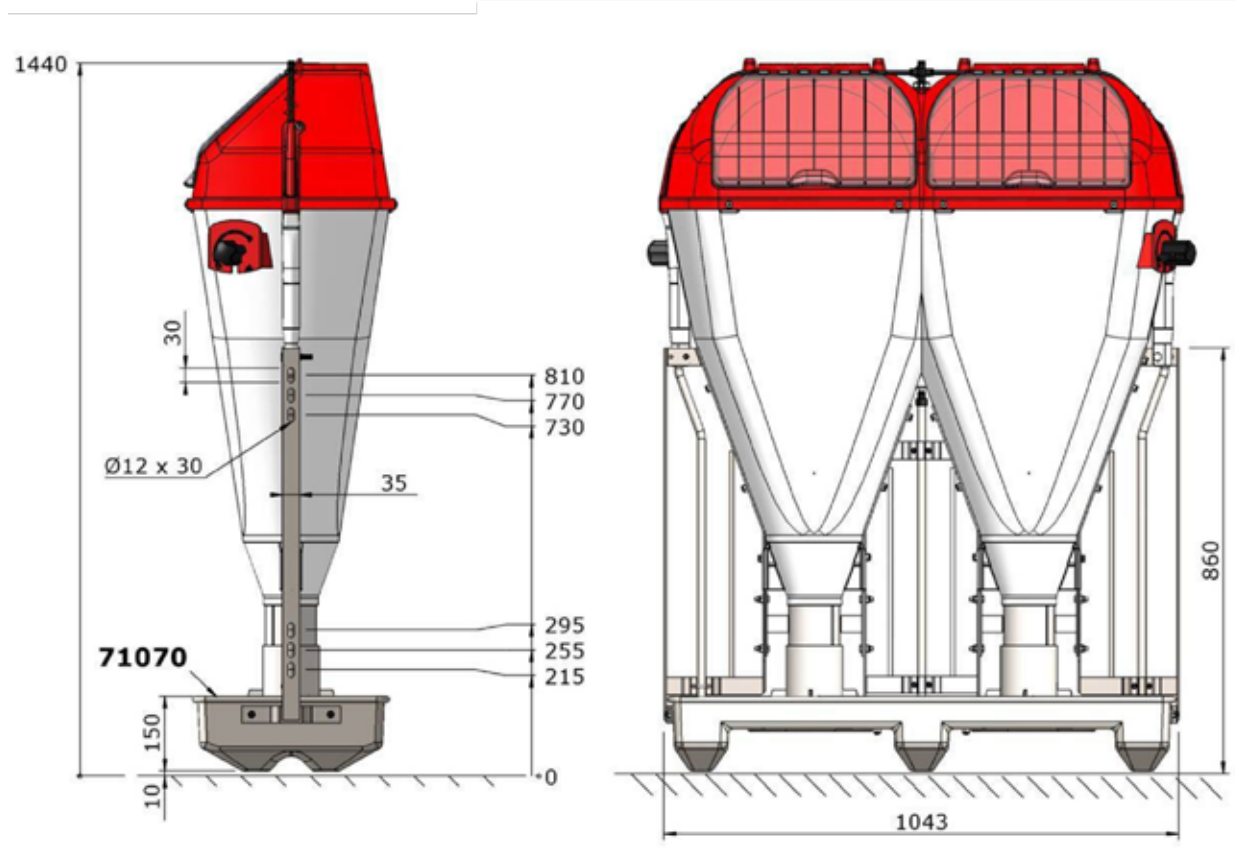



VI+



VI+ JUMBO

TUBE-O-MAT® VI+

89540	TUBE-O-MAT® VI+ WEANERS
89550	TUBE-O-MAT® VI+ WEAN-TO-FINISH
89560	TUBE-O-MAT® VI+ FINISHERS

TUBE-O-MAT® VI+ JUMBO

89650	TUBE-O-MAT® VI+ JUMBO WEAN-TO-FINISH
89660	TUBE-O-MAT® VI+ JUMBO FINISHERS



VI+
ANGLE STEEL



VI+ JUMBO
ANGLE STEEL

TUBE-O-MAT® VI+ WITH ANGLE STEEL FRAME

89545	TUBE-O-MAT® VI+ WEANERS ANGLE STEEL
89555	TUBE-O-MAT® VI+ WEAN-TO-FINISH ANGLE STEEL
89565	TUBE-O-MAT® VI+ FINISHERS ANGLE STEEL

TUBE-O-MAT® VI+ JUMBO WITH ANGLE STEEL FRAME

89655	TUBE-O-MAT® VI+ JUMBO WEAN-TO-FINISH ANGLE STEEL
89665	TUBE-O-MAT® VI+ JUMBO FINISHERS ANGLE STEEL



CLASSIC



CLASSIC JUMBO

TUBE-O-MAT® CLASSIC

89585	TUBE-O-MAT® CLASSIC WEAN-TO-FINISH
89587	TUBE-O-MAT® CLASSIC FINISHERS

TUBE-O-MAT® CLASSIC JUMBO

89685	TUBE-O-MAT® CLASSIC JUMBO WEAN-TO-FINISH
89687	TUBE-O-MAT® CLASSIC JUMBO FINISHERS



CLASSIC
ANGLE STEEL



CLASSIC JUMBO
ANGLE STEEL

TUBE-O-MAT® CLASSIC WITH ANGLE STEEL FRAME

89586	TUBE-O-MAT® CLASSIC WEAN-TO-FINISH ANGLE STEEL
89588	TUBE-O-MAT® CLASSIC FINISHERS ANGLE STEEL

TUBE-O-MAT® CLASSIC JUMBO WITH ANGLE STEEL FRAME

89686	TUBE-O-MAT® CLASSIC JUMBO WEAN-TO-FINISH ANGLE STEEL
89688	TUBE-O-MAT® CLASSIC JUMBO FINISHERS ANGLE STEEL

CHOOSE 'U' OR 'M' AFTER THE ARTICLE NR. FOR UNASSEMBLED OR ASSEMBLED FEEDER



TUBE-O-MAT® LTD

Complete program for weaners, Wean-to-Finish and finishers

VOLUME

Hopper	100 l /approx. 70 kg
Hopper Jumbo	190 l /approx. 130 kg

CAPACITY PER TROUGH

Weaners up to 30 kg:	30-50 pigs
Wean-to-Finish 7-120 kg:	30-50 pigs
Jumbo:	50-70 pigs
Finishers 18-120 kg:	30-50 pigs
Jumbo:	50-70 pigs

WATER SUPPLY

3/8" stainless steel pipe with external thread
Stainless steel press valve 93245

The original feeder:

- The design prevents bridging
- The hopper has a large filling hole and a low filling height
- The lid is closing tight and the adjustable feed supply ensures fresh feed
- The design ensures top hygiene and easy cleaning



VI+ LTD ANGLE STEEL, WEAN-TO-FINISH TROUGH

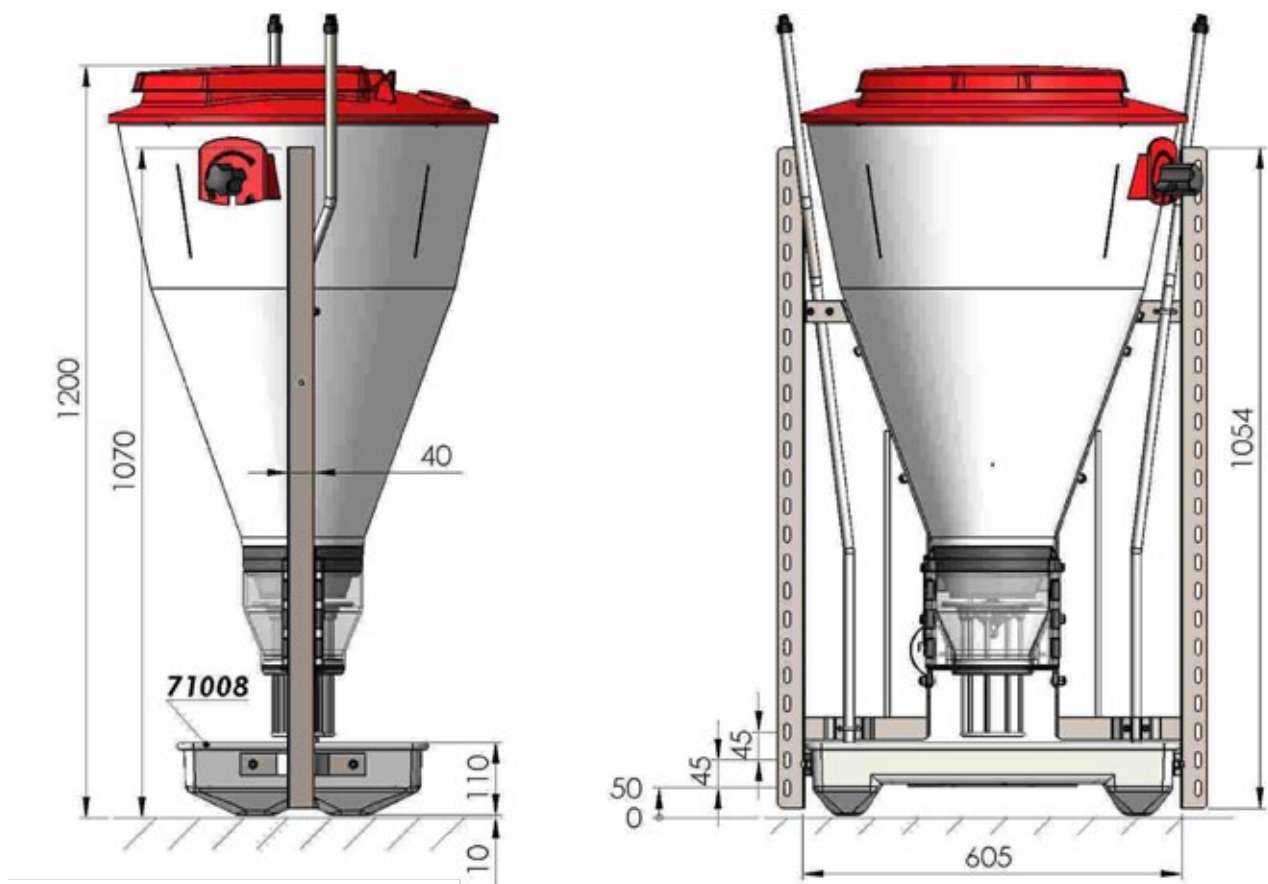

VI+ LTD JUMBO FINISHERS TROUGH

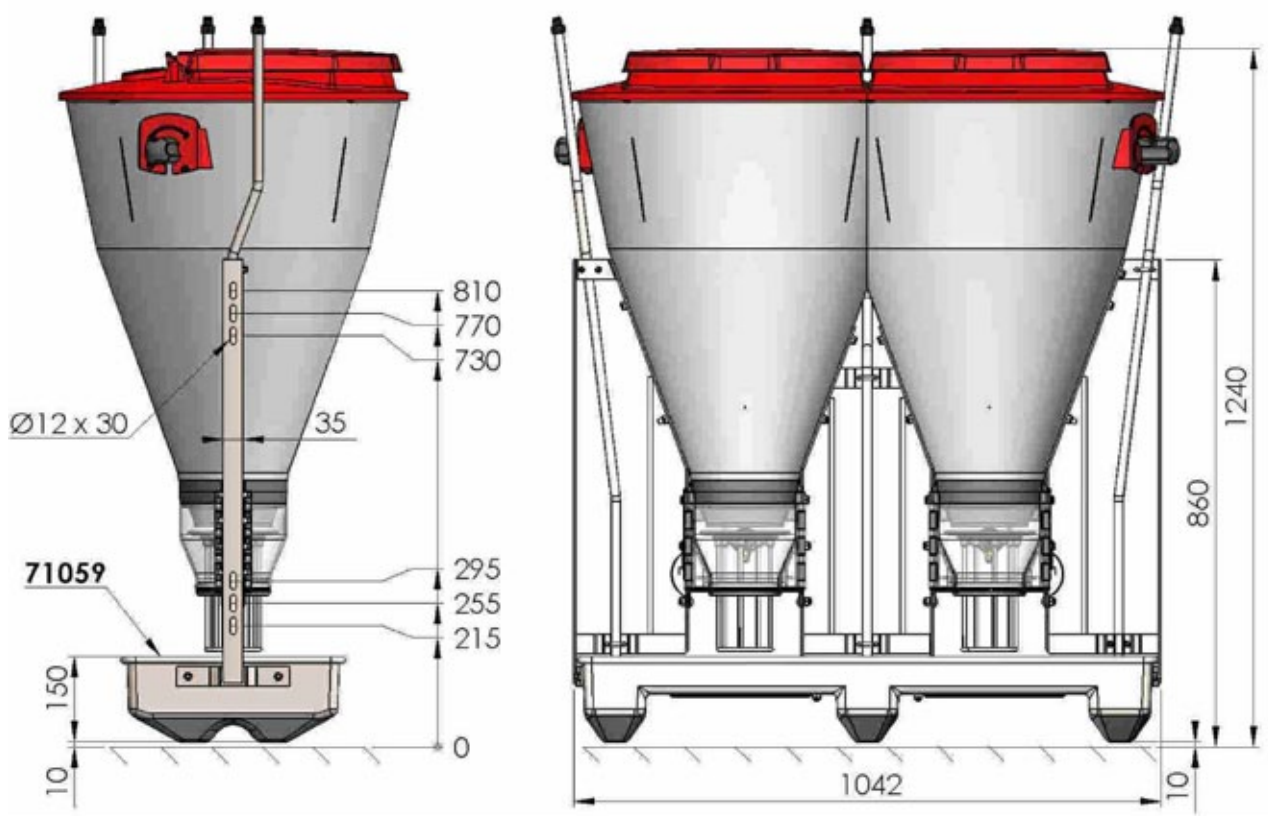

CLASSIC LTD ANGLE STEEL, FINISHERS TROUGH

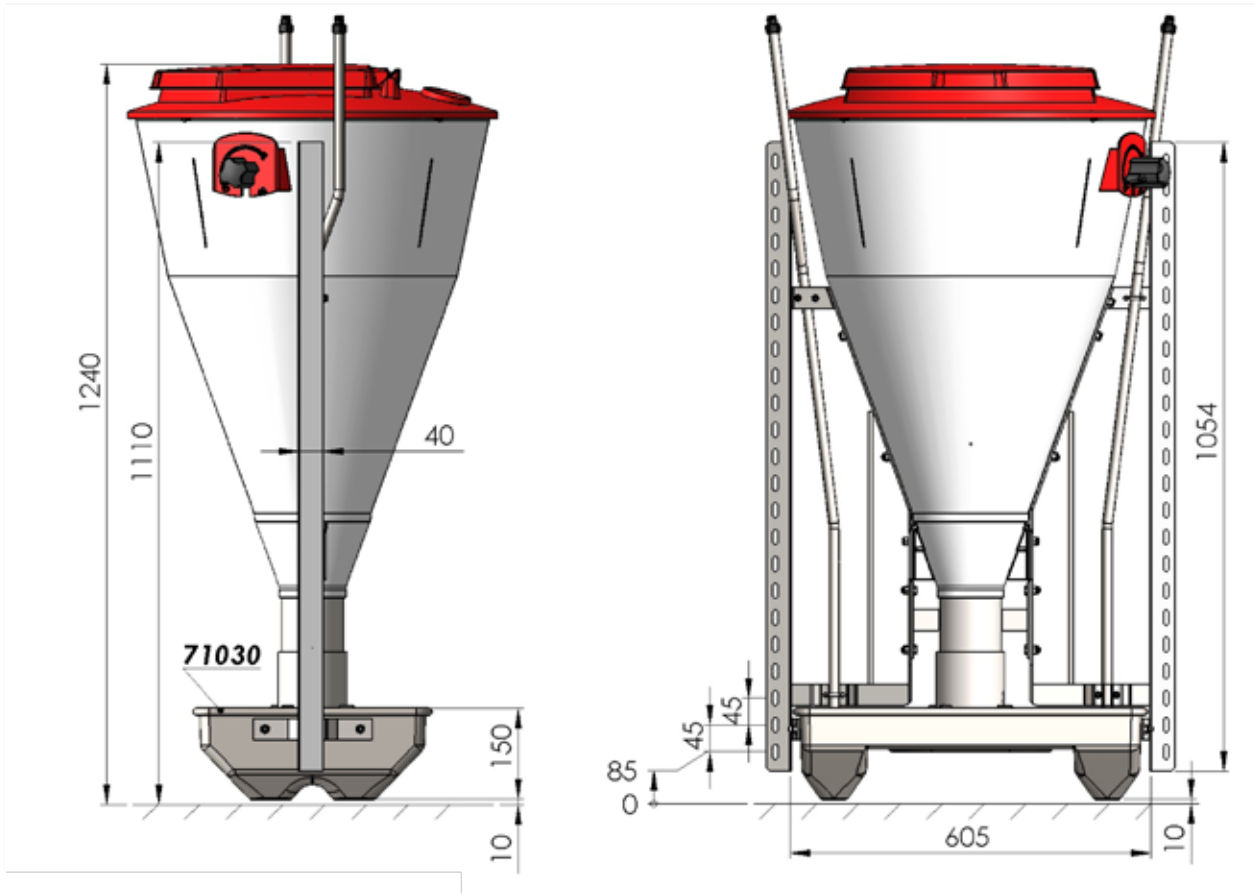

CLASSIC LTD JUMBO WEAN-TO-FINISH TROUGH

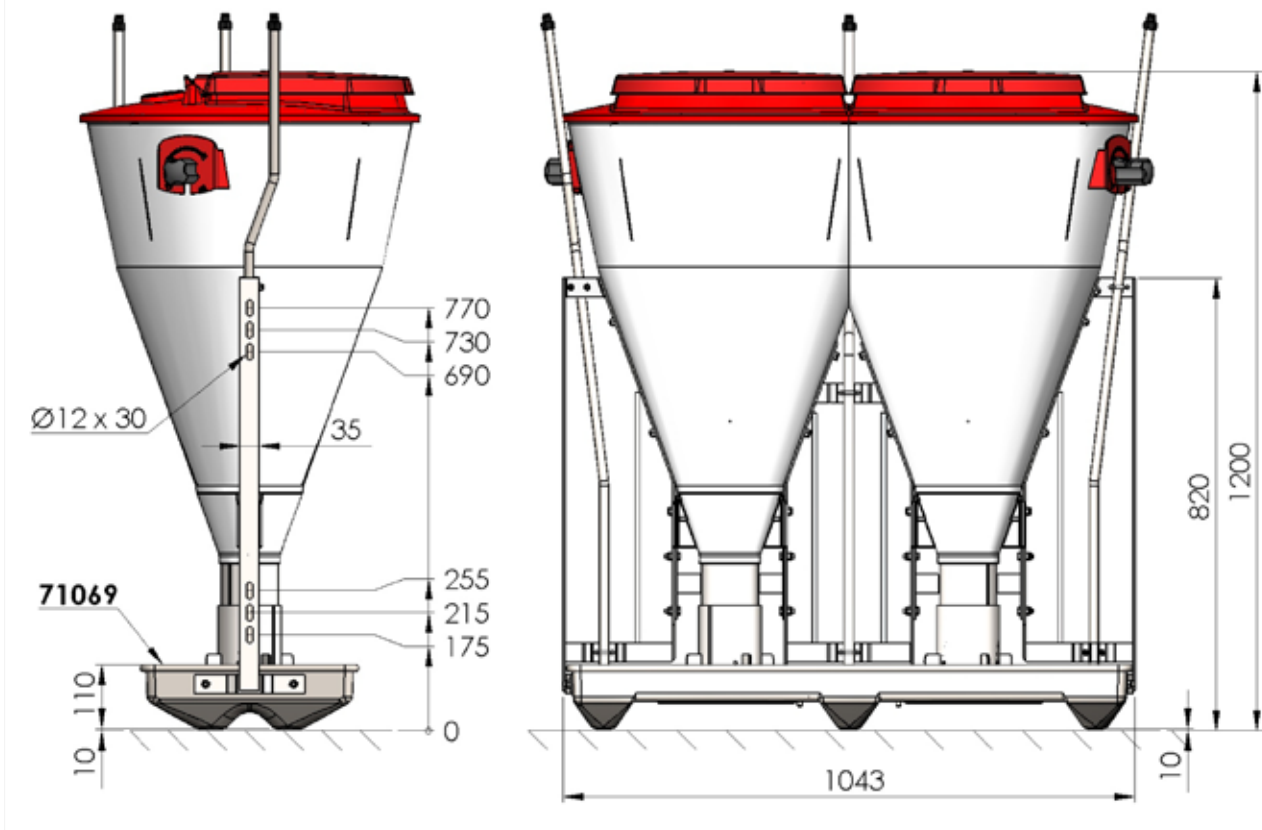

TUBE-O-MAT® VI+ LTD

89541	TUBE-O-MAT® VI+ LTD WEANERS
89551	TUBE-O-MAT® VI+ LTD WEAN-TO-FINISH
89561	TUBE-O-MAT® VI+ LTD FINISHERS



VI+ LTD



VI+ LTD JUMBO

TUBE-O-MAT® VI+ LTD JUMBO

89651	TUBE-O-MAT® VI+ LTD JUMBO WEAN-TO-FINISH
89661	TUBE-O-MAT® VI+ LTD JUMBO FINISHERS

TUBE-O-MAT® VI+ LTD WITH ANGLE STEEL FRAME

89544	TUBE-O-MAT® VI+ LTD WEANERS ANGLE STEEL
89554	TUBE-O-MAT® VI+ LTD WEAN-TO-FINISH ANGLE STEEL
89564	TUBE-O-MAT® VI+ LTD FINISHERS ANGLE STEEL



VI+ LTD ANGLE STEEL



VI+ LTD JUMBO ANGLE STEEL

TUBE-O-MAT® VI+ LTD JUMBO WITH ANGLE STEEL FRAME

89654	TUBE-O-MAT® VI+ LTD JUMBO WEAN-TO-FINISH ANGLE STEEL
89664	TUBE-O-MAT® VI+ LTD JUMBO FINISHERS ANGLE STEEL

TUBE-O-MAT® CLASSIC LTD

89590	TUBE-O-MAT® CLASSIC LTD WEAN-TO-FINISH
89595	TUBE-O-MAT® CLASSIC LTD FINISHERS



CLASSIC LTD



CLASSIC LTD JUMBO

TUBE-O-MAT® CLASSIC LTD JUMBO

89690	TUBE-O-MAT® CLASSIC LTD JUMBO WEAN-TO-FINISH
89695	TUBE-O-MAT® CLASSIC LTD JUMBO FINISHERS

TUBE-O-MAT® CLASSIC LTD WITH ANGLE STEEL FRAME

89591	TUBE-O-MAT® CLASSIC LTD WEAN-TO-FINISH ANGLE STEEL
89596	TUBE-O-MAT® CLASSIC LTD FINISHERS ANGLE STEEL



CLASSIC LTD ANGLE STEEL



CLASSIC LTD JUMBO ANGLE STEEL

TUBE-O-MAT® CLASSIC LTD JUMBO WITH ANGLE STEEL FRAME

89691	TUBE-O-MAT® CLASSIC LTD JUMBO WEAN-TO-FINISH ANGLE STEEL
89696	TUBE-O-MAT® CLASSIC LTD JUMBO FINISHERS ANGLE STEEL

CHOOSE 'U' OR 'M' AFTER THE ARTICLE NR. FOR UNASSEMBLED OR ASSEMBLED FEEDER



TUBE-O-MAT® TUBE

Feeder for finishers. The feeder is delivered with 4 mm stainless flat iron frame.

VOLUME

Tube	16 ltr./approx. 12 kg
Tube Jumbo	32 ltr./approx. 24 kg

CAPACITY PER TROUGH

Finisher 18-120 kg:	30-50 pigs
Jumbo:	50-70 pigs

WATER SUPPLY

23 x 2 mm stainless steel tube with internal thread
Stainless steel press valve, article nr. 93255

The original feeder:

- The most simple and functional feeder for finishers on the market
- Vertical feed tubes in clear plastic ensures a quick and maximum overview

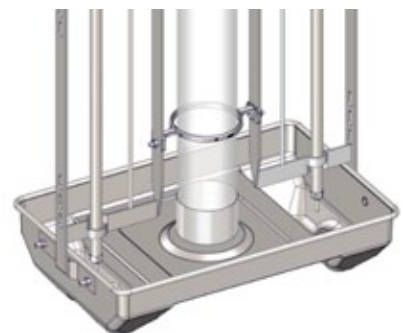

TUBE-O-MAT® TUBE + TUBE JUMBO / FINISHERS TROUGH

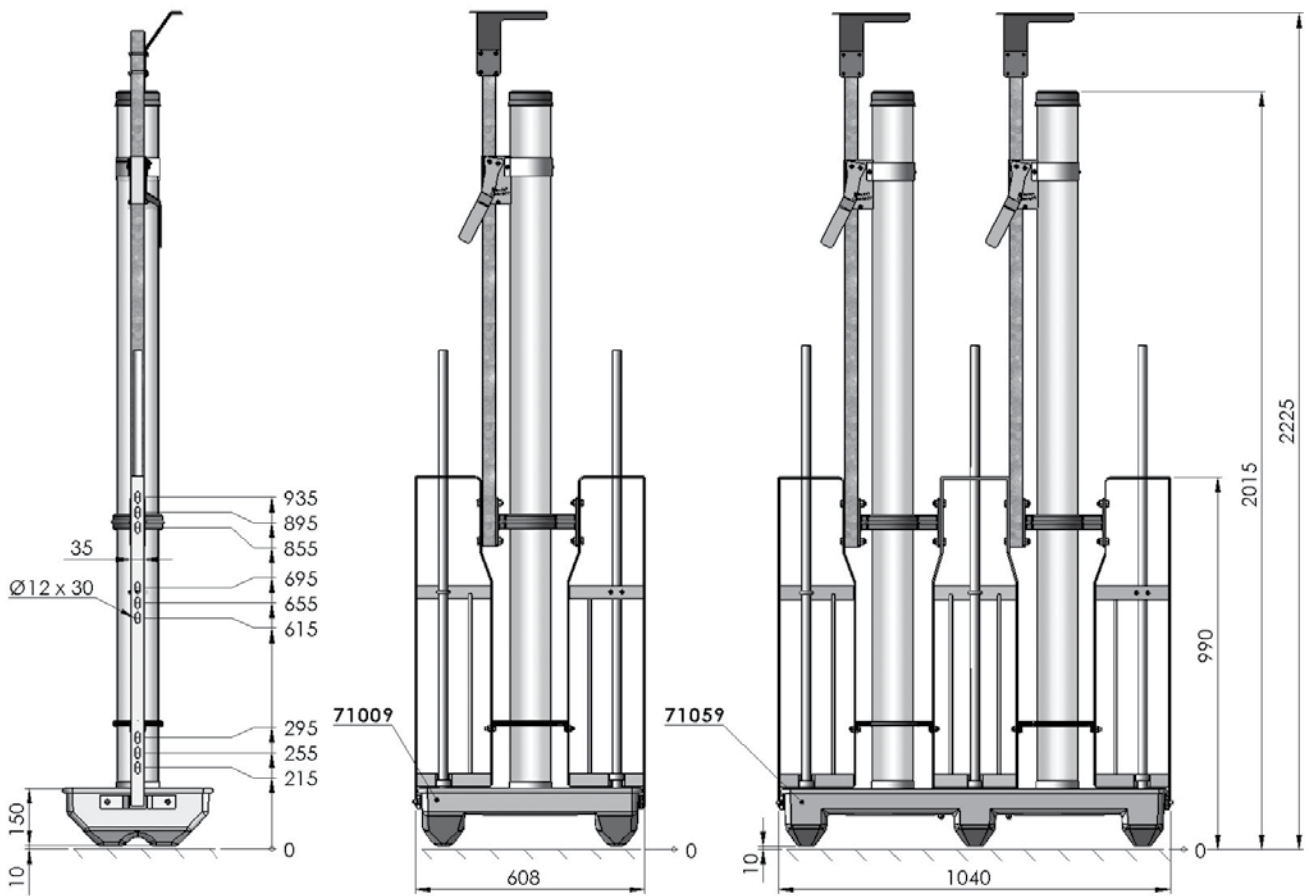

TUBE-O-MAT® TUBE

89504	TUBE-O-MAT® TUBE FINISHERS
89684	TUBE-O-MAT® TUBE JUMBO FINISHERS



TUBE

TUBE JUMBO

CHOOSE 'U' OR 'M' AFTER THE ARTICLE NR. FOR UNASSEMBLED OR ASSEMBLED FEEDER



FUNKIMAT® FEEDER

For weaners and finishers

CAPACITY PER FEEDER

FUNKIMAT	50 pigs (6-120 kg)
3IN1 ROTO	50 pigs (6-120 kg)
DOUBLE	80 weaners / 70 finishers

VOLUME

FUNKIMAT	100 L
3IN1 ROTO	100 L
DOUBLE	200 L

- Can be used for both flour and pellets
- No feed waste
- No bridging
- The handle allows easy and fast regulation of feeding
- Exact feed dosage ensures fresh feed always

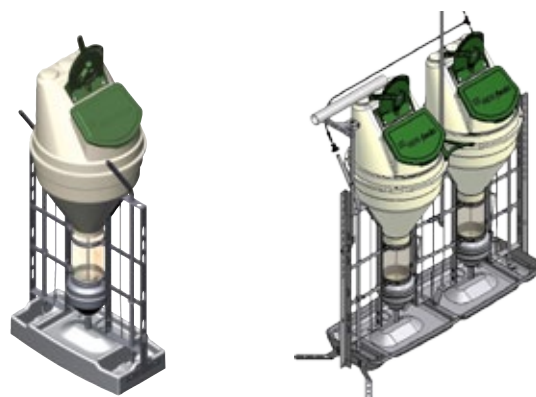

FUNKIMAT

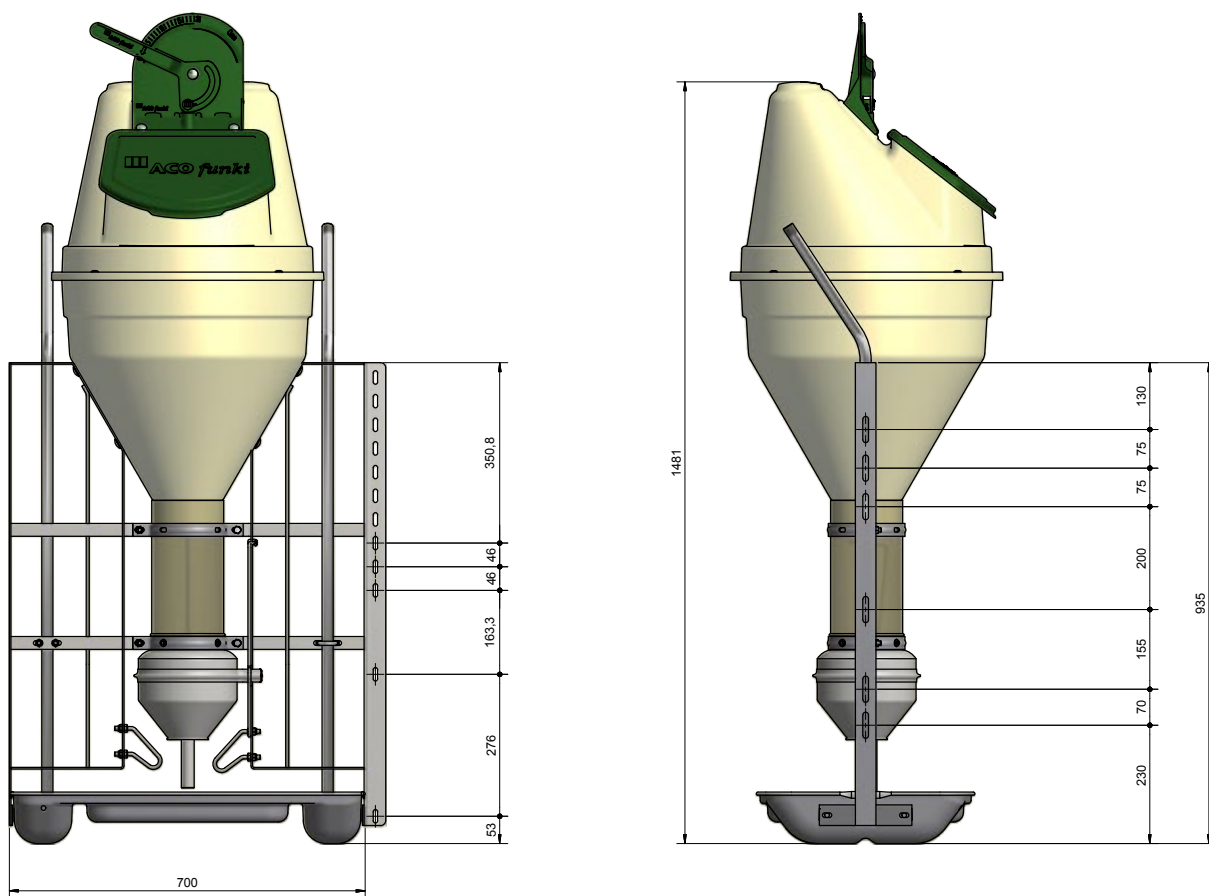

FUNKIMAT DOUBLE

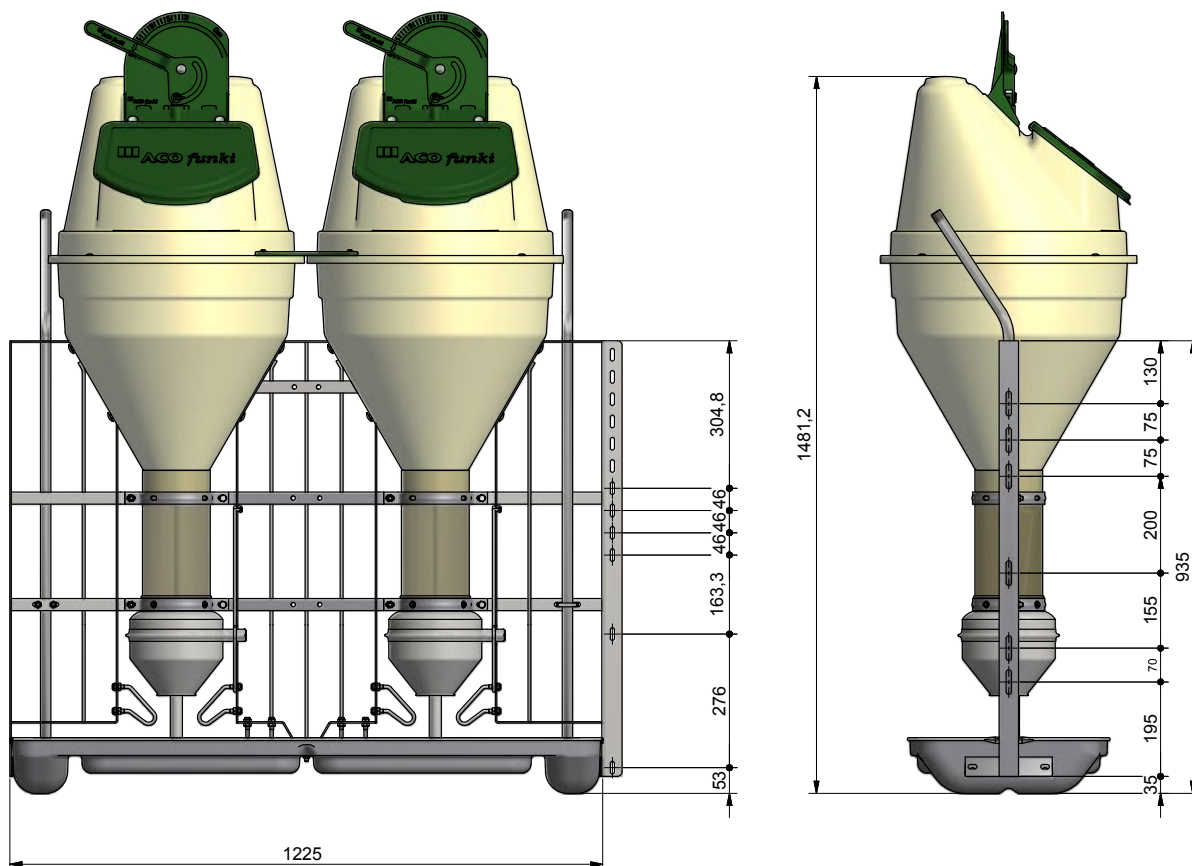



FUNKIMAT - ASSEMBLED

0227-550	FUNKIMAT VERS.3 (FLAT-FLAT)
0227-551	FUNKIMAT VERS.3 (ANGLE-ANGLE)
0227-552	FUNKIMAT VERS.3 (FLAT-ANGLE)

FUNKIMAT - UNASSEMBLED

0227-570	FUNKIMAT VERS.3 (FLAT-FLAT)
0227-571	FUNKIMAT VERS.3 (ANGLE-ANGLE)
0227-572	FUNKIMAT VERS.3 (FLAT-ANGLE)

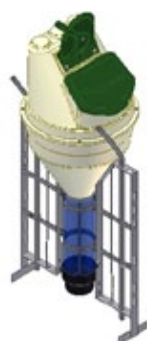

3IN1 ROTO - ASSEMBLED

0227-555	3I1 ROTO VERS.1 (FLAT-FLAT)
0227-556	3I1 ROTO VERS.1 (ANGLE-ANGLE)
0227-557	3I1 ROTO VERS.1 (FLAT-ANGLE)

3IN1 ROTO - UNASSEMBLED

0227-573	3I1 ROTO VERS.1 (FLAT-FLAT)
0227-574	3I1 ROTO VERS.1 (ANGLE-ANGLE)
0227-575	3I1 ROTO VERS.1 (FLAT-ANGLE)



FUNKIMAT DOUBLE - ASSEMBLED

0227-870	FUNKIMAT DOUBLE (FLAT-FLAT) WEANERS
0227-871	FUNKIMAT DOUBLE (ANGLE-ANGLE) WEANERS
0227-872	FUNKIMAT DOUBLE (FLAT-ANGLE) WEANERS
0227-970	FUNKIMAT DOUBLE (FLAT-FLAT) FINISHERS
0227-971	FUNKIMAT DOUBLE (ANGLE-ANGLE) FINISHERS
0227-972	FUNKIMAT DOUBLE (FLAT-ANGLE) FINISHERS

FUNKIMAT DOUBLE - UNASSEMBLED

0227-670	FUNKIMAT DOUBLE (FLAT-FLAT)
0227-671	FUNKIMAT DOUBLE (ANGLE-ANGLE)
0227-672	FUNKIMAT DOUBLE (FLAT-ANGLE)



3IN1 ROTO DOUBLE - ASSEMBLED

0227-873	DOUBLE 3I1 ROTO (FLAT-FLAT) WEANERS
0227-874	DOUBLE 3I1 ROTO (ANGLE-ANGLE) WEANERS
0227-875	DOUBLE 3I1 ROTO (FLAT-ANGLE) WEANERS
0227-973	DOUBLE 3I1 ROTO (FLAT-FLAT) FINISHERS
0227-974	DOUBLE 3I1 ROTO (ANGLE-ANGLE) FINISHERS
0227-975	DOUBLE 3I1 ROTO (FLAT-ANGLE) FINISHERS

3IN1 ROTO DOUBLE - UNASSEMBLED

0227-673	DOUBLE 3I1 ROTO (FLAT-FLAT)
0227-674	DOUBLE 3I1 ROTO (ANGLE-ANGLE)
0227-675	DOUBLE 3I1 ROTO (FLAT-ANGLE)



ACCESSORIES FOR FEEDERS

Reliable feed intake from day 1

TROUGHS

TUBE-O-MAT	Stainless steel
FUNKIMAT	Stainless steel / Polymer

FEED OUTLET

38 / 50 / 60 mm
Straight or Y-model

PROTECTION SHEETS UNDER FEEDER

100 x 80 cm
120 x 80 cm
120 x 60 cm
80 x 60 cm

- The water supply is made of flexible PE-hoses clicked on to the feeders lid. The hoses can be lead along the vertical feed downpipes, so fewer parts are in the way in the pen and it makes cleaning and installation quick and simple.
- The plastic sheet under the feeder protects it against corrosion.

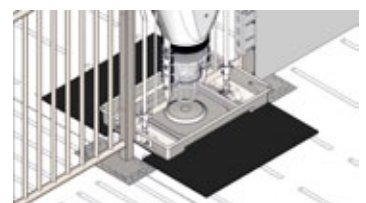
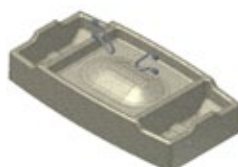

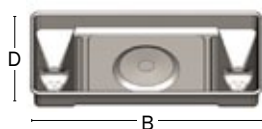

DEEP DRAWN TROUGHS FOR VI+, 30-50 PIGS PER TROUGH		D X B, CM
71007	FOR VI+ WEANERS 7-30 KG, H: 11 CM	30 X 60
71008	FOR VI+ WEAN-TO-FINISH 7-120 KG, H: 11 CM	40 X 60
71009	FOR VI+ FINISHERS 18-120 KG, H: 15 CM	40 X 60

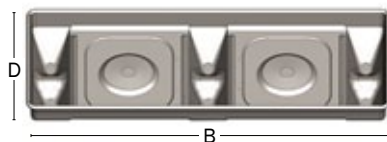

DEEP DRAWN TROUGHS FOR VI+ JUMBO, 50-70 PIGS PER TROUGH		
71058	FOR VI+ JUMBO WEAN-TO-FINISH, H: 11 CM	40 X 103,5
71059	FOR VI+ JUMBO FINISHERS, H: 15 CM	40 X 103,5

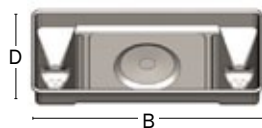

DEEP DRAWN TROUGHS FOR CLASSIC, 30-50 PIGS PER TROUGH		
71029	FOR WEAN-TO-FINISH 7-120 KG, H: 11 CM	40 X 60

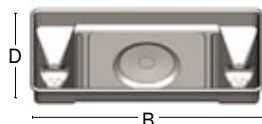

DEEP DRAWN TROUGHS FOR CLASSIC & TUBE, 30-50 PIGS PER TROUGH		
71030	FOR FINISHERS 18-120 KG, H: 15 CM	40 X 60

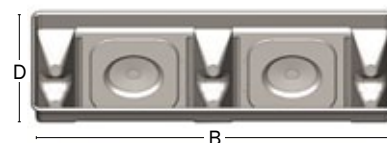

DEEP DRAWN TROUGHS FOR CLASSIC & TUBE JUMBO, 50-70 PIGS PER TROUGH		
71069	FOR WEAN-TO-FINISH 7-120 KG, H: 11 CM	40 X 103,5
71070	FOR FINISHERS 18-120 KG, H: 15 CM	40 X 103,5

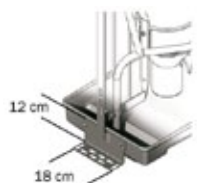

FOOT BRACKETS FOR TUBE-O-MAT®	
74502	FOOT BRACKET HEIGHT 12 CM, WIDTH 18 CM WEAN-TO-FINISH
74504	FOOT BRACKET HEIGHT 12 CM, WIDTH 25 CM WEAN-TO-FINISH
74501	FOOT BRACKET HEIGHT 16 CM, WIDTH 18 CM FINISHERS
74503	FOOT BRACKET HEIGHT 16 CM, WIDTH 25 CM FINISHERS

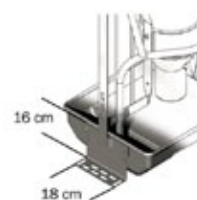

FEED OUTLET L=100 CM

90550	FEED OUTLET 38 MM WITH FIXED T-PIECE
90552	FEED OUTLET 50 MM WITH FIXED T-PIECE
90554	FEED OUTLET 60 MM WITH FIXED T-PIECE



FEED OUTLET Y-MODEL

90571	FEED OUTLET 38 MM WITH FIXED T-PIECE
90573	FEED OUTLET 50 MM WITH FIXED T-PIECE
90574	FEED OUTLET 60 MM WITH FIXED T-PIECE



FEED OUTLET FOR TUBE FEEDER

90560	FEED OUTLET 38 MM WITH FIXED T-PIECE
90562	FEED OUTLET 50 MM WITH FIXED T-PIECE
90564	FEED OUTLET 60 MM WITH FIXED T-PIECE



T-PIECE

90482	FIXED T-PIECE FOR 38 MM
90484	FIXED T-PIECE FOR 50 MM
90486	FIXED T-PIECE FOR 60 MM



T-PIECE WITH SLIDE

0142-015	T-PIECE WITH SLIDE Ø38
0232-010	T-PIECE WITH SLIDE Ø60



TELESCOPIC DOWNPIPE

0228-595	TELESCOPIC DOWNPIPE
----------	---------------------



WATER SUPPLY

61012	HOSE 8 MM PE
-------	--------------



PROTECTION SHEETS

89014	PLASTIC SHEET FOR SINGLE TUBE-O-MAT 100 X 80 CM
89016	PLASTIC SHEET FOR DOUBLE TUBE-O-MAT 120 X 80 CM
554167	TILE 80X60 CM
554168	TILE 120X60 CM FOR 3IN1 AUTOMAT, 2 PCS. PER FEEDER





TROUGHS FOR FUNKIMAT - STAINLESS

0227-710	DEEP DRAWN TROUGH FOR WEANERS
0227-711	DEEP DRAWN TROUGH FOR FINISHERS

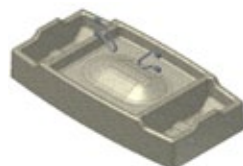

TROUGHS FOR FUNKIMAT - POLYMER

0227-560	POLYMER TROUGH FOR WEANERS
0227-561	POLYMER TROUGH FOR FINISHERS



TROUGHS FOR DOUBLE FUNKIMAT - STAINLESS

0227-714	DEEP DRAWN TROUGH FOR WEANERS
0227-715	DEEP DRAWN TROUGH FOR FINISHERS



TROUGHS FOR 3IN1 ROTO - STAINLESS

0227-712	DEEP DRAWN TROUGH FOR WEANERS
0227-713	DEEP DRAWN TROUGH FOR FINISHERS

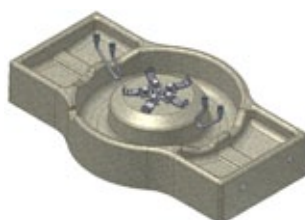

TROUGHS FOR 3IN1 ROTO - POLYMER

0227-562	POLYMER TROUGH FOR WEANERS
0227-563	POLYMER TROUGH FOR FINISHERS



TROUGHS FOR DOUBLE 3IN1 ROTO - STAINLESS

0227-716	DEEP DRAWN TROUGH FOR WEANERS
0227-717	DEEP DRAWN TROUGH FOR FINISHERS



WATER SUPPLY, 10 MM AQUASPEED WITH 1/2" EXTERNAL THREAD

0227-580	FOR SINGLE FEEDER
0227-579	FOR DOUBLE FEEDER



MOUNTING ACCESSORIES

0227-150	TROUGH FOOT STAINLESS ADJUSTABLE
0227-274	SOLID POST FOR FUNKIMAT 950 MM
0227-366	POST FOR DOUBLE FUNKIMAT 948 MM

CCM-FEEDER

18090	CCM-FEEDER MINI: 40 L FOR WEANERS 5-35 KG, 30-40 PIGS PER FEEDER, TROUGH Ø50/H:10 CM
18746	CCM MAXI TYPE II: 71 L FOR FINISHERS 25-115 KG, 30-40 PIGS PER FEEDER, TROUGH WITH DOME

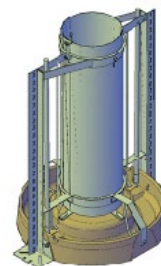

PLASTIC FEEDER

90011	PLASTIC FEEDER FOR PIGLETS TYPE 301
-------	-------------------------------------



PLASTIC FEEDERS

90012	FEEDER MINI FOR PIGLETS, INCL. FITTINGS
90013	FEEDER MINI FOR PIGLETS, INCL. BOLTS/NUTS
90144	BRACKET FOR FEEDER MINI



“BABY TROUGH”

2900314	“BABY TROUGH” FOR PIGLETS PLASTIC 0,9L
2900005	SLIDING FIT BRACKET, INCL BOLTS FOR BOARD PROFILE



FEEDER FOR FLOOR MOUNTING

96061	FEEDER FOR PIGLETS Ø26 CM
96063	FEEDER FOR PIGLETS Ø39 CM



BOWLS - POLYMER

06906	ROUND BOWL FTK-27 WITH CONE AND INNER RIM, H: 8 CM, Ø27
03186	FEEDING BOWL FT-19, H: 8 CM, Ø19 CM
554154	FEEDING BOWL 326-T, H: 6 CM, Ø26 CM

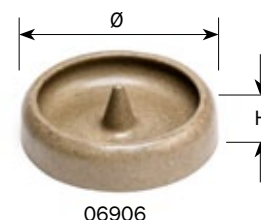

06906

DRINKING/FEEDING BOWLS - STAINLESS

9910012	DRINKING/FEED BOWL, 1 LITER
9910013	DRINKING/FEED BOWL, 2 LITER
17395	FEEDING BOWL FT-27 3 LITER, WITH FIXING HOOK



17395

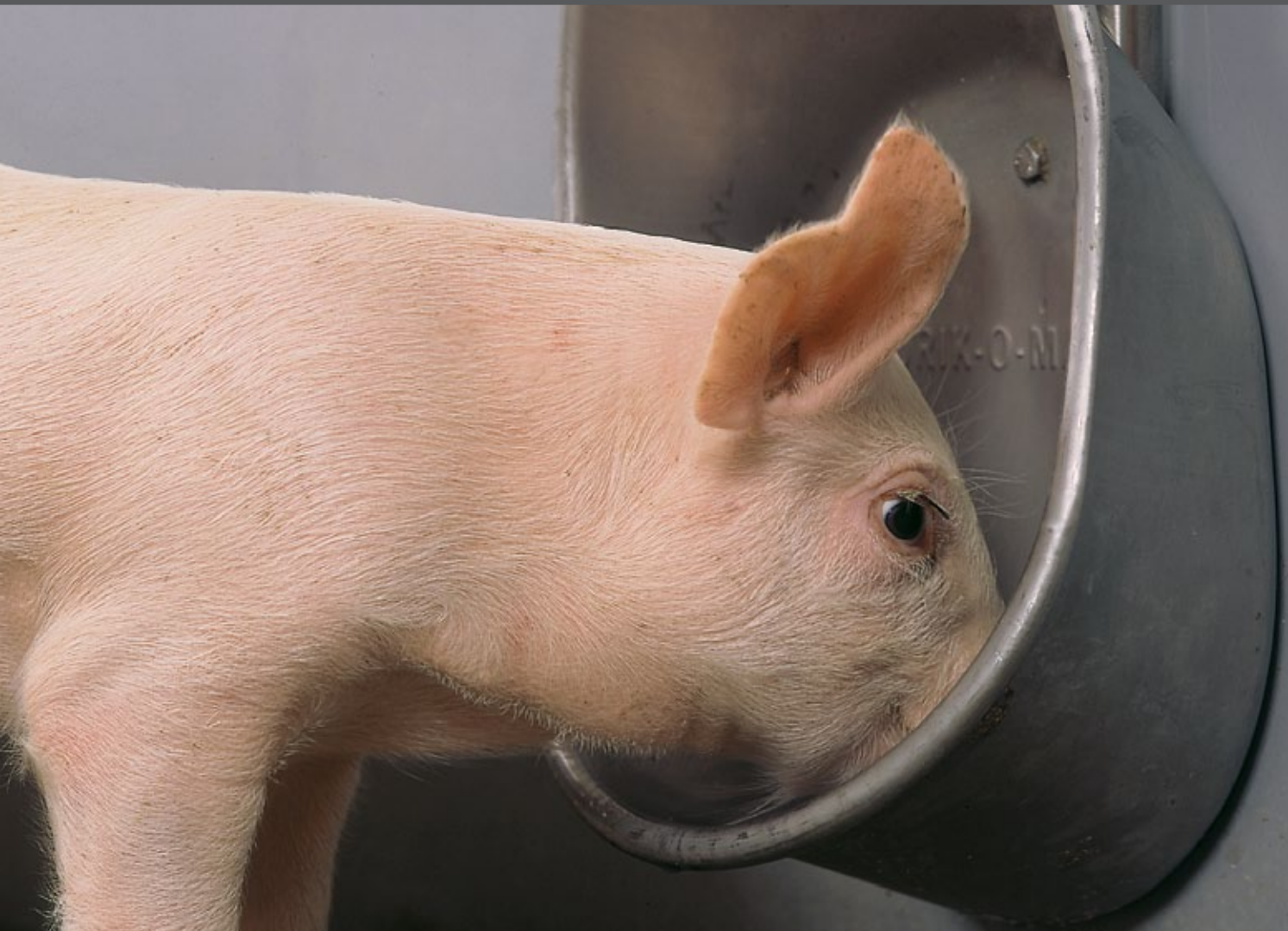

THE ORIGINAL DRIK-O-MAT®

The design of DRIK-O-MAT® drinking cups gives a number of unique advantages

DRINKING CUP	Deep drawn stainless steel
WATER SUPPLY	
Water pipe	24,5 x 2 mm stainless pipe with internal thread
Press nipple	Adjustable press nipple, stainless, 1-4 l/min at 2,5 bar ½" ext. thread, article 93250

CAPACITY	MOUNTING HEIGHT, CM	
VIP-O-MAT	5	1 litter piglets
Mini	12	30 weaners
Standard	25	30 finishers
Multi	12	30 weaners
	12	20 finishers
	35	10 sows
Maxi	35	10 sows

The best economy on the long term:

- Strong and durable construction: heavy thickness of material and bent edges
- Hygienic: closed edges and bend design prevent dirt and feed remnants accumulating
- Good water economy and low quantity of slurry: it releases only the amount of water necessary for drinking at the moment



DRIK-O-MAT® DRINKING CUPS

93570	DRIK-O-MAT MINI - FOR WEANERS 30 PIGS PER CUP MOUNTING HEIGHT* - 12 CM
93575	DRIK-O-MAT STANDARD - FOR FINISHERS 30 PIGS PER CUP MOUNTING HEIGHT - 25 CM
93600	DRIK-O-MAT MULTI - FOR WEAN-TO-FINISH AND SOWS 30 WEANERS PER CUP - MOUNTING HEIGHT 12 CM 20 FINISHERS PER CUP - MOUNTING HEIGHT 12 CM 10 SOWS PER CUP - MOUNTING HEIGHT 35 CM
93500	DRIK-O-MAT MAXI - FOR SOWS 10 PIGS PER CUP MOUNTING HEIGHT 35 CM



VIP-O-MAT DRINKING CUP FOR PIGLETS

93520	VIP-O-MAT INCL. HOSE PROTECTOR
43611	VIP-O-MAT SINGLE INCL. WATER SUPPLY
43612	VIP-O-MAT DOUBLE INCL. WATER SUPPLY



MASTER FLOW WATER LEVEL VALVE

93469	MASTER FLOW INCL. 1/2" PLUG
93467	MASTER FLOW MEMBRANE
93465	MASTER FLOW CONTROL BUTTON



NIPPLE PIPE 1/2", STAINLESS

94039	NIPPLE PIPE 830 MM WITH THREAD
06902111	NIPPLE PIPE 990 MM WITH THREAD
06902112	NIPPLE PIPE 1190 MM WITH THREAD
06902113	NIPPLE PIPE 1700 MM WITH THREAD



DRINKER FOR PIGLETS

2100622	DRINKER FOR PIGLETS, ADJUSTABLE HEIGHT
12100108	VALVE FOR PIGLET DRINKER



* Mounting height = from the floor to the cup lower front edge.



PRESS NIPPLES		L/MIN*
281490	FOR OLDER TUBE-O-MAT 1/2" EXT. THREAD	4
93305	FOR OLDER TUBE-O-MAT 1/2" INT. THREAD	4
9900004	FOR FINISHERS / SOWS 1" BRASS	2,5



PRESS NIPPLES		L/MIN*
93245	FOR TUBE-O-MAT® 3/8" INT. THREAD	4
93250	FOR DRIK-O-MAT® 1/2" EXT. THREAD	4
281496	FOR TUBE-O-MAT® TUBE, 1/2" EXT. THREAD	4
12100107	1/2" INT. THREAD	5
12100342	1/2" INT. THREAD	4
93280	FOR SOWS 1/2" EXT. THREAD	4
9900047	FOR SOWS 1/2" INT. THREAD	7



BITE NIPPLES		L/MIN*
93345	FOR PIGLETS 3/8" EXT. THREAD	1,5
9900054	FOR FINISHERS 1/2" EXT. THREAD	4
9900053	FOR WEANERS 1/2" EXT. THREAD	2,5

* **NB!** Our nipples are designed for a water pressure of 2,5 Bar. The adjustment is needed for a stronger water pressure. All measurements are made with the nipples adjusted to the maximum water flow!

MASTER CLAMP WATER PIPE BRACKETS

19900	MASTER CLAMP 1" WATER PIPE BRACKET ON WALL
19910	MASTER CLAMP 1" WATER PIPE BRACKET ON WALL
19920	MASTER CLAMP 1" WATER PIPE BRACKET ON PIPE
19930	MASTER CLAMP 1" WATER PIPE BRACKET ON BOARD PROFILE
19940	MASTER CLAMP 1" WATER PIPE BRACKET ON BOARD PROFILE, DOUBLE
19950	MASTER CLAMP 1" WATER PIPE BRACKET ON LIGHT MATERIAL WALL
19960	MASTER CLAMP 1" WATER PIPE BRACKET FOR BARS
20035	MASTER CLAMP 1" WATER PIPE BRACKET
20045	DISTANCE PIECE FOR MASTER CLAMP
20039	PLASTIC LINER FOR MASTER CLAMP FOR 23 MM PIPE
20040	PLASTIC LINER FOR MASTER CLAMP 1/2" PIPE
20041	PLASTIC LINER FOR MASTER CLAMP FOR 3/4" PIPE
20037	MASTER CLAMP WASHER Ø10, 5/Ø451,5 A2

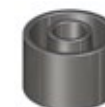



20052	REAR PLATE, OFFSET, FOR MASTER CLAMP BRACKET
-------	--



20051	REAR PLATE FOR MASTER CLAMP WATER PIPE BRACKET
-------	--



20005	WATER PIPE BRACKET 1/2" PIPE, SOW TROUGH
-------	--



20007	WATER PIPE BRACKET FOR 23 MM PIPE
-------	-----------------------------------



20019	WATER PIPE BRACKET 1/4" PIPE ON WALL
-------	--------------------------------------



20032	1" PIPE BRACKET FOR COVER BOARD PEN WITH STOP SCREW
-------	---



20014	PIPE CLAMP FITTING 1" INCL. M8 STOP SCREW
-------	---



1910172	PIPE CLAMP FITTING 1" - 1/2" STAINLESS STEEL, INCL. BOLT
---------	--

DRILL CLAMPS



61195	DRILL CLAMP 8 - 32/33,7 MM PLASTIC
-------	------------------------------------



93164	DRILL CLAMP 1" - 1/2" STAINLESS
-------	---------------------------------



93212	GASKET FOR DRILL CLAMP
-------	------------------------



93204	DRILL CLAMP 1/2" - 1/2" EXT. THREAD, COMPLET
-------	--



93205	DRILL CLAMP 1" - 1/2" EXT. THREAD, COMPLET
-------	--



INN-O-CRATE® FARROWING PEN

Traditional farrowing pen with multi-adjustable farrowing crate

FACTS

Pen length:	260/270 cm
Pen width:	160/170/180 cm
Pen height:	50 cm
U-profiles:	1,5 mm stainless st.
Board profiles:	35 x 500 mm
Lying length	200-210 cm
Width farrowing crate, front	52-61 cm
Width farrowing crate, rear gate	57-85 cm
Height crate side:	90 cm
Farrowing crate trough rail:	40 x 40 x 4 mm
Crate side:	33,7/42,4 x 2,65 pipe
Volume trough:	21 liter
Piglets nest width:	80/90 cm
Piglets nest area:	0,7/0,8 m ²

Maximum production:

- More weaned piglets and higher weight at weaning
- Anatomic design of the crate ensures a safe movement behaviour
- The piglets have free access to the utter
- Durable sows, natural behaviour
- Maximum feed and water intake
- Large hygienic trough and crate design, that makes it easy for the sow to get up





INN-O-CORNER® PIGLET NEST

Ensures the optimum climate for piglets

FACTS

Material: Injection moulded polypropylene
Width: 80 cm (0,68 m²)
 90 cm (0,80 m²)

INN-O-BLOCK BARRIER PLATE

- Matches INN-O-CORNER in design and function
- Easy inspection - free view of the piglets
- Low weight - easy to handle

- Optimum climate
- Closed side construction and tight joints between the cover area and the fixed part
- Up to 0,8 m² covered area
- Individual adjustment possible
- Easy access - light construction
- Slope on all cover parts makes them easy to clean



INN-O-CORNER 80 CM

44080	PIGLET NEST LEFT
44090	PIGLET NEST RIGHT



INN-O-CORNER 90 CM

44060	PIGLET NEST LEFT
44070	PIGLET NEST RIGHT

TOP PROFILE AGAINST AISLE

44004	TOP PROFILE LEFT WITHOUT BOLTS
43515	TOP PROFILE LEFT WITH BOLTS
44005	TOP PROFILE RIGHT WITHOUT BOLTS
43510	TOP PROFILE RIGHT WITH BOLTS



TOP PROFILE AGAINST WALL / BOARD PROFILE

44006	TOP PROFILE LEFT AGAINST WALL WITHOUT BOLTS
43517	TOP PROFILE LEFT AGAINST WALL WITH BOLTS
44007	TOP PROFILE RIGHT AGAINST WALL WITHOUT BOLTS
43512	TOP PROFILE RIGHT AGAINST WALL WITH BOLTS
43516	TOP PROFILE LEFT AGAINST BOARD PROFILE WITH BOLTS
43511	TOP PROFILE RIGHT AGAINST BOARD PROFILE WITH BOLTS



TOP PROFILE DOUBLE

44008	TOP PROFILE DOUBLE WITHOUT BOLTS
41147	TOP PROFILE DOUBLE WITH BOLTS



INN-O-BLOCK BARRIER PLATE

44215	INN-O-BLOCK BARRIER PLATE 80 CM
44210	INN-O-BLOCK BARRIER PLATE 90 CM
44220	BARRIER PLATE WITH HOLE



RUBBER FLOOR

44112	RUBBER FLOOR FOR PIGLET NEST 80 CM, REVERSIBLE
44118	RUBBER FLOOR FOR PIGLET NEST 90 CM, REVERSIBLE



HEATING LAMP

96341	MASTER LAMP WITH REGULAR PLUG
96342	MASTER LAMP CE-PLUG COMPLET
2960510	LID FOR HEATING LAMP



HEAT BULB

9971013	HEAT BULB 100W, COMPLET WITH 12 PCS., CLEAR
9971014	HEAT BULB 100W, COMPLET WITH 12 PCS., RED





FUNKI FARROWING PEN F207

Sow crate with extra space even for the largest sows

FACTS

Pen length	260/270 cm
Pen width	160/165/170 cm
Pen height	50/100 cm
Board profile	35 mm
Crate length	230/250 cm (incl. trough)
Soft rear gate	Durable rounded design with soft plastic coating
Trough capacity	20 l - stainless trough Bioform III 24 l - polymer trough 21 l - plastic trough
Piglet nest width	80/90 cm
Piglet nest length	120 cm
Piglet nest height	40 cm

- Maximum space for weaners at nursing period
- Simple and efficient adjustment of the sow crate
- Plastic coated soft rear gate - comfortable for sow
- Extra large piglet nest for later weaning
- Also delivered as sideways pens



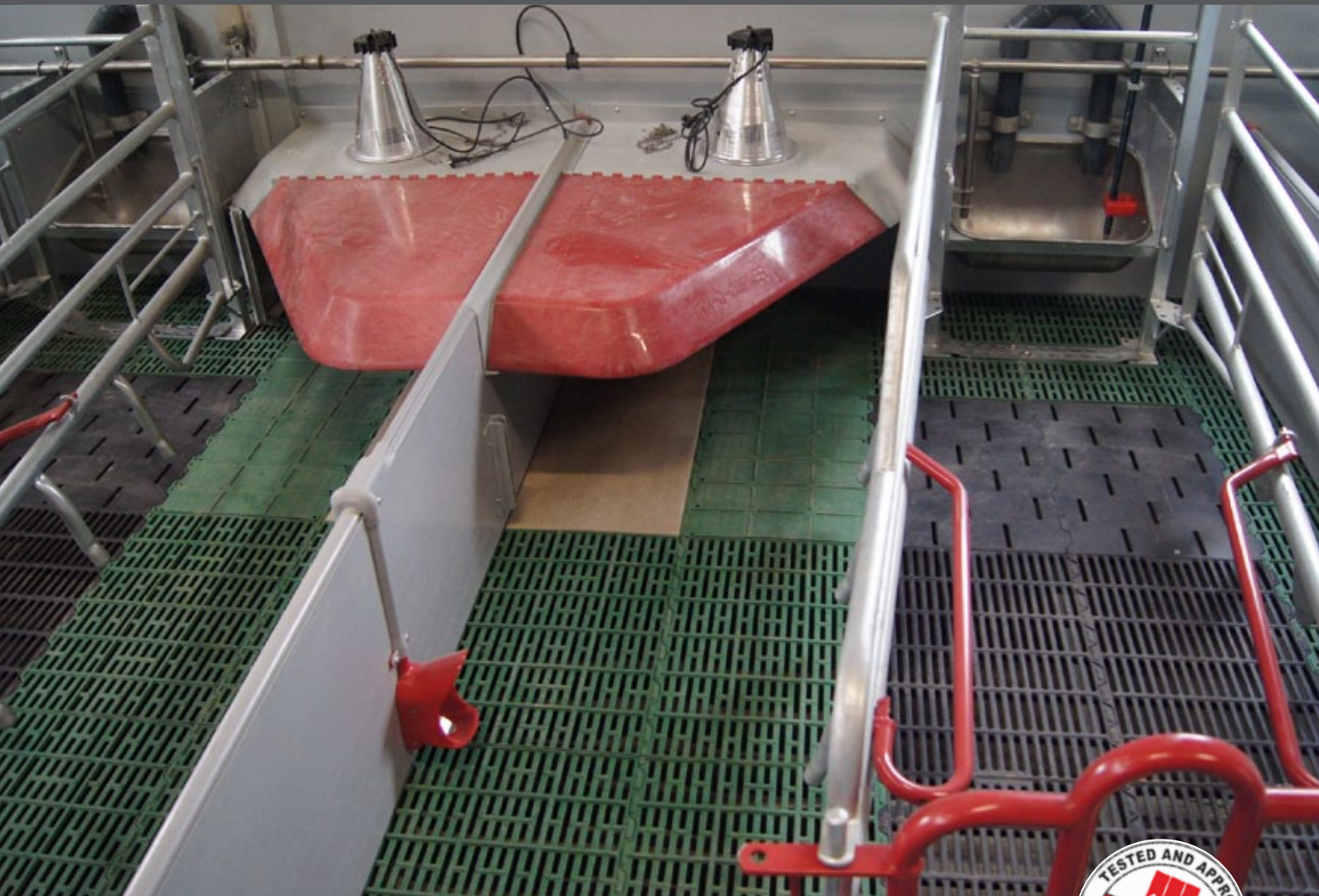

COMBI-FLOOR



Wide assortment of plastic slats, cast iron slats, supports and heating plates

- High quality plastic slats from the own production in Germany
- Flexibility since the components can be combined according to your needs
- Competitive prices, short delivery times
- Green colour as a sign of good quality
- No recycling materials - only pure PP

We ensure high quality through impartial quality control.



Slats with 5% opening is designed to reduce pressure sore while being sure that the sow has a dry and cool area.

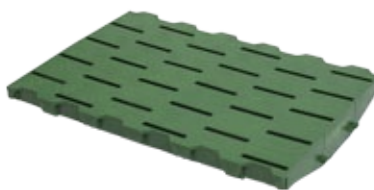

Try our special plastic slats for weaners with an innovative textured surface, that helps weaners to keep warm and keep them dry.



Special STEP system makes it possible to raise the sow's lying area and reduce the mortality of piglets.



STEP-SLAT

564061	40 X 60 CM STEP, FOR SOWS
--------	---------------------------



STEP-SLAT, CLOSED

564062	40 X 60 CM STEP CLOSED, FOR SOWS
--------	----------------------------------



CAST IRON SLAT, 5% OPENING

566041	60 X 40 CM 5% ÅBNING, FOR SOWS
--------	--------------------------------



CAST IRON SLAT, CLOSED

564063	40 X 60 CM FOR SOWS
--------	---------------------



CAST IRON SLAT

561060	10 X 60 CM FOR SOWS
564060	40 X 60 CM FOR SOWS
566040	60 X 40 CM FOR SOWS
566060	60 X 60 CM FOR SOWS



CAST IRON SLAT, WITH PLUG

563060	30 X 60 CM WITH PLUG, FOR SOWS
566063	60 X 60 CM WITH PLUG, FOR SOWS



CLEANING PLUGS FOR CAST IRON SLATS

563061	PLUG FOR 563060
566064	PLUG FOR 566063

PLASTIC SLAT FOR WEANERS, 10% OPENING

18604	60 X 40 CM 10% OPENING
-------	------------------------

PLASTIC SLAT FOR WEANERS

09100	60 X 40 CM
17384	60 X 50 CM

PLASTIC SLAT FOR SOWS 60 X 50 CM

565060	60 X 50 CM
--------	------------



AGROMEK
STAR 2016

PLASTIC SLAT FOR SOWS CLOSED

17383	60 X 40 CM CLOSED
-------	-------------------

PLASTIC SLAT FOR SOWS

18054	10 X 40 CM
-------	------------

PLASTIC SLAT FOR SOWS

18094	30 X 20 CM
-------	------------

PLASTIC SLAT FOR SOWS

17328	30 X 30 CM
-------	------------

PLASTIC SLAT FOR SOWS

18721	30 X 60 CM
-------	------------

PLASTIC SLAT FOR SOWS

09102	60 X 40 CM
-------	------------

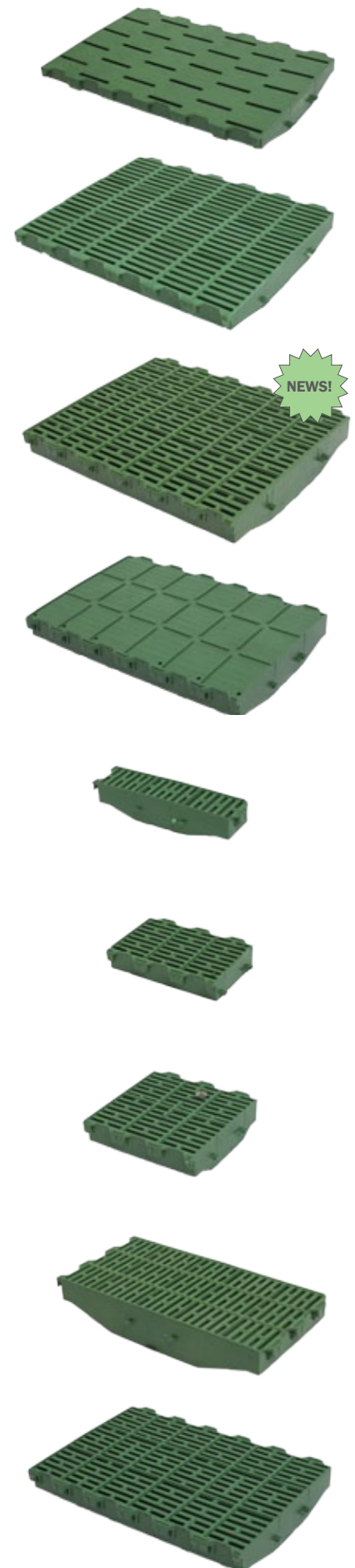

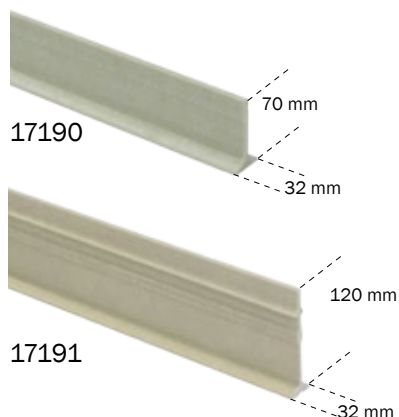

FIBER GLASS SUPPORT

17189	70 X 32 MM, LENGTH 6 METER
17190	70 X 32 MM, SPEC. LENGTH
17191	120 X 32 MM, LENGTH 5 METER
17192	120 X 32 MM, LENGTH 5,5 M
17193	120 X 32 MM, LENGTH 6 M
17194	120 X 32 MM, SPEC. LENGTH

WALL HOLDER FOR FIBER GLASS SUPPORT

17234	WALL HOLDER FOR FIBER GLASS AND STEEL SUPPORTS
-------	--



FIBER GLASS SUPPORT

96980	FOOT FOR SUPPORT LEG, SET, FOR FIBER GLASS SUPPORT
20000065	PIPE PVC Ø50 X 2,4, 10 BAR, PRICE PER METER

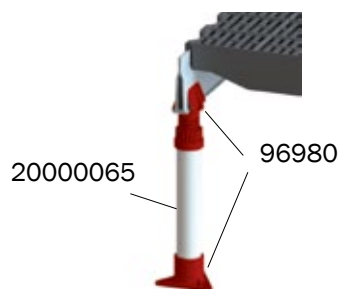

DELTA SUPPORT

96976	120 X 30 MM, SPEC. LENGTH
560285	120 X 30 MM, LENGTH 2,85 M
560290	120 X 30 MM, LENGTH 9 M

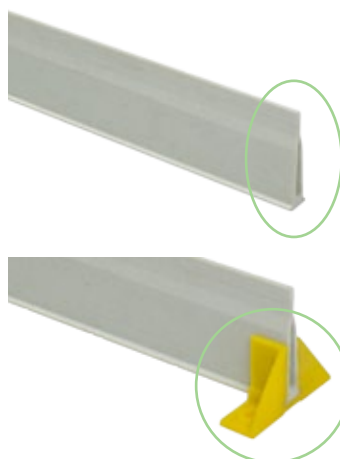

FOOT FOR SUPPORT

96982	MOUNTING BRACKET FOR FIBER GLASS BEAM
-------	---------------------------------------

MAX SPAN LENGTH, CM

	WEANERS	SOWS	WITH CAST IRON UNDER SOW
70 x 32 mm	160	120	-
120 x 32 mm	280	240	260
DELTA	310	270	280

FITTING FOR SOW SLAT

17667 | FITTING FOR SOW SLAT 40 CM, GREEN

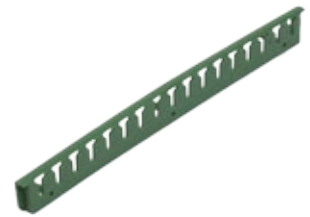
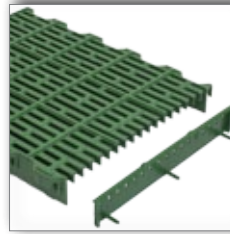

FILLERS FOR PLASTIC SLAT

09105 | FILLERS FOR PLASTIC SLATS



CROSS-SECTION ADAPTER FOR PLASTIC SLAT

18083 | CROSS-SECTION ADAPTER FOR PLASTIC SLAT 20 CM

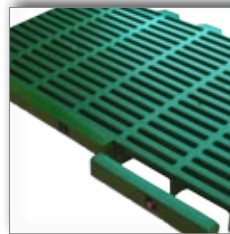

SPACER FOR PP FLOOR

8500301 | SPACER FOR PP FLOOR 30 X 40 X 58,3 MM

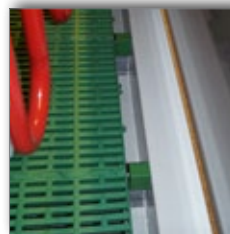

MUCK TRAP, STAINLESS STEEL

18169 | MUCK TRAP FOR FARROWING PENS 38,5 X 18,5 CM



CLEANING PLUG

01777 | CLEANING PLUG L13 X B10 X H15 CM

554164 | CLEANING PLUG L21 X B13 X H7 CM

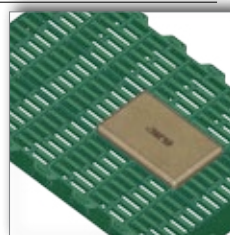



“COMFORT PLATE” POLYMER PLATE

560305	POLYMER PLATE FOR FARROWING PEN 60X40 CM
560310	POLYMER PLATE FOR FARROWING PEN, COMPLETE WITH 3 PCS.PLASTIC FRAMES



SUPPORT FOR POLYMER PLATE

560300	PLASTIC GRATING FRAME 20 X 40 CM (3 PCS. PER 1 POLYMER PLATE)
--------	--

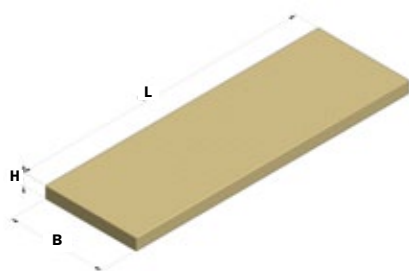

HEATING PLATES - HOT WATER, H: 5 CM

12630	L: 140 x B: 50, 240W WITH ½” PIPE INT. THREAD, PVC
12631	L: 120 x B: 40, 240W WITH ½” PIPE INT. THREAD, PVC
12633	L: 120 x B: 50, 120W WITH ½” PIPE INT. THREAD, PVC
17813	L: 120 x B: 60, 160W
17814	L: 120 x B: 60, 4S 4 SIDED
17634	L: 120 x B: 60, 3S, 3 SIDED
17640	L: 120 x B: 60, 2S 2 SIDED

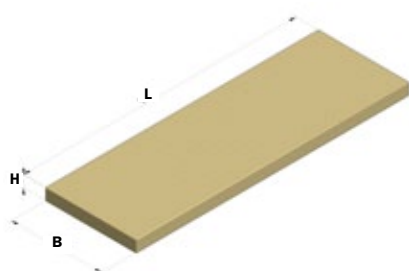

HEATING PLATES - EL, H: 5 CM

17582	L: 120 x B: 40E - 230V, 130W
18409	L: 120 x B: 50E - 230V, 180W
17792	L: 120 x B: 80E - 230V, 270W
18855	L: 140 x B: 50E - 230V, 180W



BRACKET KIT FOR HEATING PLATE

4960560	BRACKET KIT FOR HEATING PLATE
---------	-------------------------------

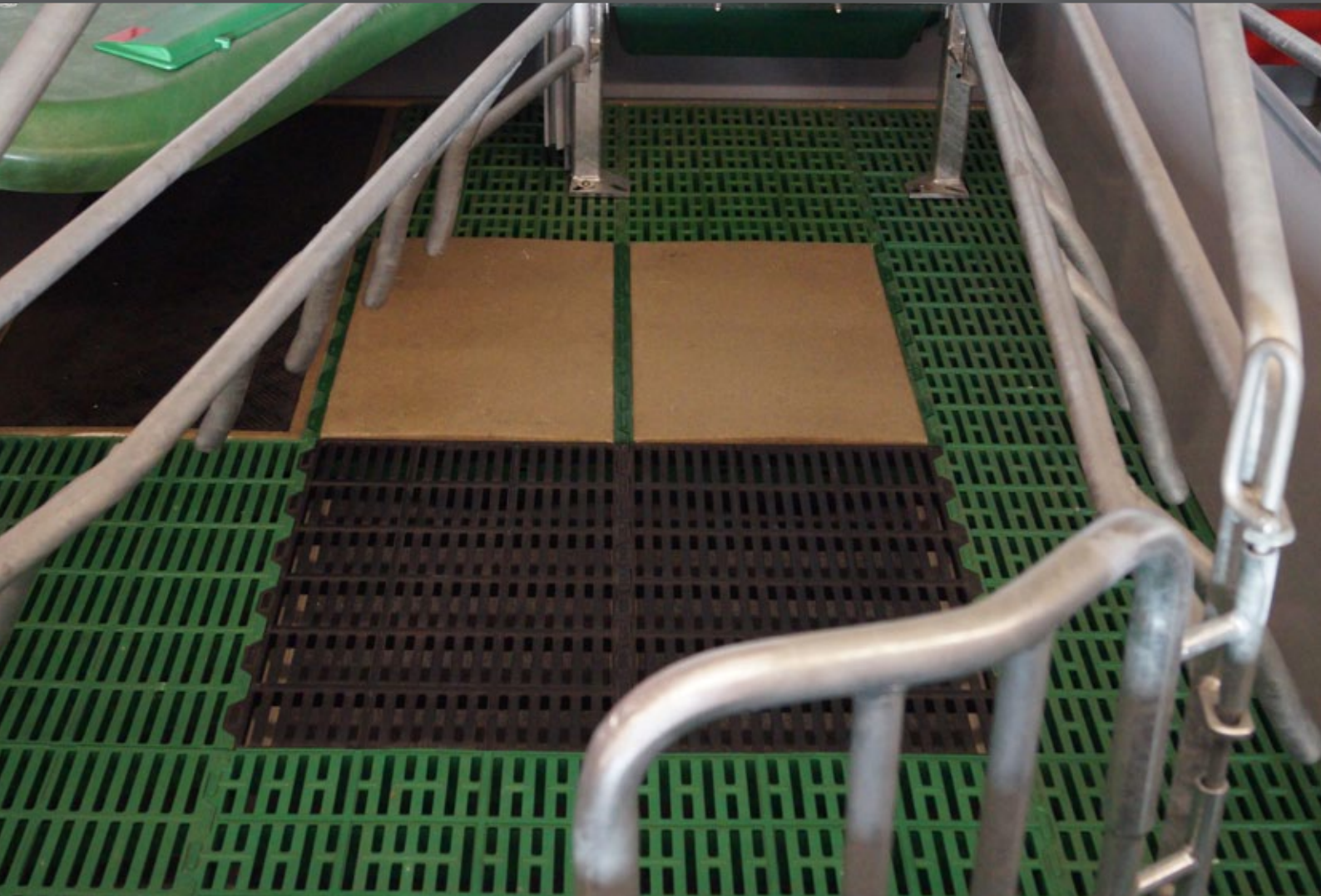

COMFORT PLATE - POLYMER PLATE

Polymer plate for farrowing pens

FACTS

Dimensions

60 x 40 cm

Material

Polymer concrete



**AGROMEK
STAR 2016**

- Designed to cool the sow and at the same time to ensure a dry area for the sow
- Comfort Plate can be used as a substitute for ordinary concrete tiles, if they have become rough in the surface
- Lasts longer than ordinary concrete
- No sharp edges => protecting the sows against shoulder damages
- Non-slip surface
- The plate is supported and held in place by a specially designed plastic support, which ensures that the plate follows the floor surface





SELF-SUPPORTING CAST IRON SLATS

"Best in test"

Material:

Cast iron GGG40

Dimensions:

FARROWING PENS

Rib	10 mm
Opening	10 mm
Cleaning opening	40 mm

WEANERS & WEAN-TO-FINISH PENS

Rib	12,5 mm
Opening	12,5 mm
Cleaning opening	40 mm

FINISHERS

Rib	30 mm
Opening	15 mm
Cleaning opening	40 mm

The healthy condition

- Slightly textured surface makes the slat nonslip
- T-shaped ribs ensure optimal manure passage

Minimum time consumption

- Large cleaning opening, hard surface and minimum surface area

Environment and economy

- Long durability, self supporting = low mounting costs

Our cast iron slats are tested and approved in Germany

IWS

INSTITUT FÜR WERKSTOFFKUNDE UND SCHWEISSTECHNIK SERVICE GMBH



Specially adapted for plugs

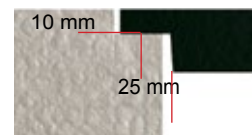

Same bearing surface and height as i.e. triangle slats

CAST IRON SLATS FOR FARROWING PENS WITH CLEANING OPENING 10/11 MM SLOT OPENING

560800	80 X 40 CM
560900	90 X 40 CM
561000	100 X 40 CM
561100	110 X 40 CM
549655	120 X 40 CM
561400	140 X 40 CM
561600	160 X 40 CM



CAST IRON SLATS FOR WEANERS AND WEAN-TO-FINISH PENS WITH CLEANING OPENING, 12/13 MM SLOT OPENING

561203	120 X 40 CM
549800	140 X 40 CM
549656	160 X 40 CM
561803	180 X 40 CM
549849	200 X 40 CM



CAST IRON SLATS FOR FINISHERS WITH CLEANING OPENING 30/15 MM SLOT OPENING

95816	160 X 40 CM
562003	200 X 40 CM



CAST IRON SLATS FOR SOWS 10/11 MM SLOT OPENING

17339	80 X 50 CM
17341	100 X 50 CM ANTI-SLIP
17342	120 X 50 CM ANTI-SLIP

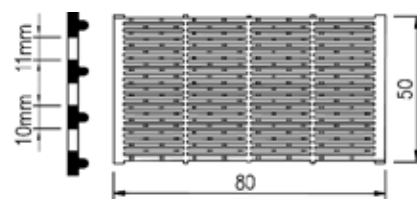

PLUG FOR CAST IRON SLATS

560111	IRON PLUG FOR CAST IRON SLATS 56XXXX
--------	--------------------------------------



PLUG FOR CAST IRON SLATS

92630	PLUG FOR CAST IRON SLATS 54XXXX
-------	---------------------------------





PVC BOARD PROFILES

Durable and tight-fitting equipment

PVC BOARD PROFILES

Material: PVC

HEIGHT:

For 35 mm 250 mm
 500 mm
 750 mm

For 40 mm

200 mm
 500 mm

U-PROFILES

Material: Stainless steel

Length: Tailor-made dimensions.

HYGIENE AND DURABILITY:

- Tight, smooth and hard surface
- Rubber strips are adhered on board profiles outer side for tighter joints
- Zigzag lamellar structure provides high pressure and torsional stiffness

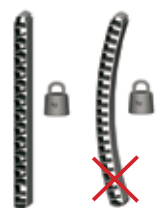

CLEAN-O-FLEX® bottom profile

- Complement your CLEAN-O-FLEX®-concept
- Tight connection from equipment to floor
- Sloped feet reduces the amount of manure on the equipment



“PROFF LINE STEEL” U-PROFILE

- Inwards curved edges
- Variable distance between the holes in the side
- Variable distance between the holes in the back

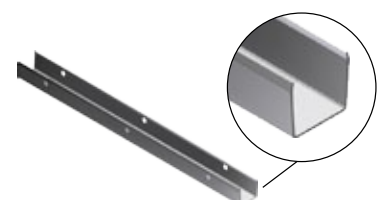

PVC BOARD PROFILES 35 MM HEIGHT 25 CM

30099	35X250 MM FEDER/NOT PRICE PER METER
30100	35X250 MM FEDER/NOT LENGTH 6 METERS

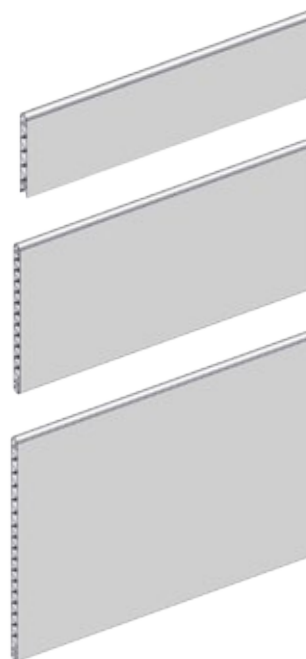

PVC BOARD PROFILES 35 MM HEIGHT 50 CM

30102	35X500 MM FEDER/NOT PRICE PER METER
30103	35X500 MM FEDER/NOT LENGTH 6 METERS

PVC BOARD PROFILES 35 MM HEIGHT 75 CM

30105	35X750 MM FEDER/NOT PRICE PER METER
30106	35X750 MM FEDER/NOT LENGTH 6 METERS

PVC BOARD PROFILES 35 MM

8535506	35 X 500 MM FLAT/FLAT LENGTH 6 METERS
8535756	35 X 750 MM FLAT/FLAT LENGTH 6 METERS
8535106	35 X 1000 MM FLAT/FLAT LENGTH 6 METERS

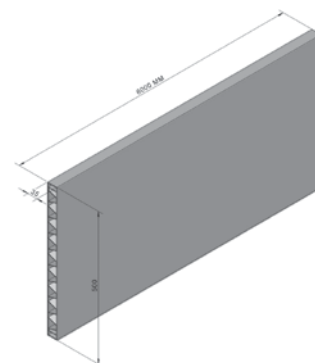

PVC BOARD PROFILES 40 MM HEIGHT 20 CM

8640206	40X200 FEDER/NOT 6 METERS
9340461	40X200 FEDER/NOT PRICE PER METER



PVC BOARD PROFILES 40 MM HEIGHT 50 CM

8640506	40X500 FEDER/NOT 6 METERS
9340471	40X500 FEDER/NOT PRICE PER METER



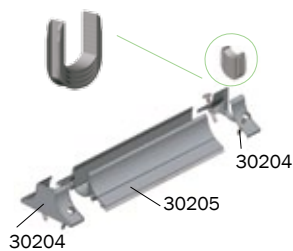

FLOOR PROFILES FOR PVC BOARD PROFILES

30205	FLOOR PROFILE
30204	KIT FOR FLOOR PROFILE WITH BASE FOR BOARD PROFILE, EXCL. FLOOR PROFILE

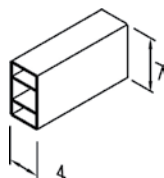

BAR PROFILE

18276	BAR PROFILE 70X40 6 METERS
17004	BAR PROFILE 70X40 PRICE PER METER



ENDCAP FOR BAR PROFILE

17005	ENDCAP FOR BAR PROFILE 70 X 40 MM
-------	-----------------------------------



PIPE JOINT

17637	PIPE JOINT
-------	------------

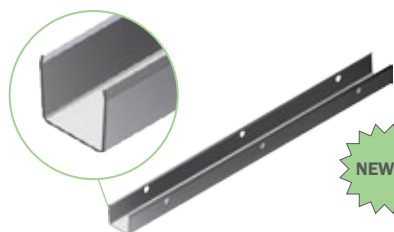

U-PROFILES FOR 35 MM PVC BOARD PROFILES

<i>Request article nr.</i>	TAILOR-MADE DEPENDING ON EQUIPMENT TYPE
----------------------------	---



U-PROFILES FOR 40 MM PVC BOARD PROFILES

<i>Request article nr.</i>	TAILOR-MADE DEPENDING ON EQUIPMENT TYPE
----------------------------	---



U-PROFILE PLASTIC

2900358	U-PROFILE PLASTIC 6,5 METERS
---------	------------------------------



POST PROFILE PVC

2900357	POST PROFILE PVC 6,5 METER
---------	----------------------------



DOWNPIPE FOR LIQUID FEEDING WAL, FOR 35 MM BOARD PROFILE

30149	DOWNPIPE FOR LIQUID FEEDING WALL L=950 MM
-------	---



FUNKI FLEX® PENNING EQUIPMENT

PVC modules and components

MATERIALS:

Corrosion free materials

PVC

Stainless steel

HEIGHT:

75 and 100 cm

- Flexible pen system for weaners and finishers
- Corrosion free materials, PVC and stainless steel, good hygiene
- PVC board profiles are closed from the top and from the bottom
- Strong posts without holes with rounded and smooth surface
- Durable foot plates made of stainless steel or cast iron
- Easy and quick to mount
- One-hand operated closing mechanism in an elegant design
- Height 75 cm for weaners and 100 cm for finishers

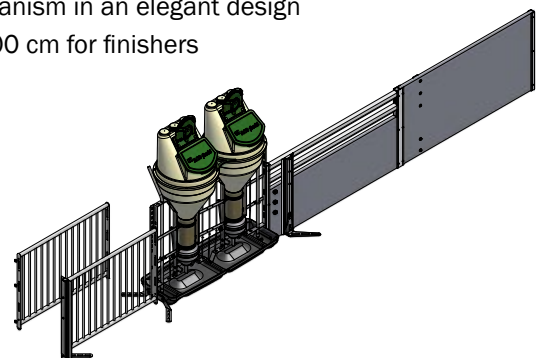



FOUNDATION PLATE FOR PVC POST

4120120	FOUNDATION PLATE RIGHT, GALVANIZED
4120121	FOUNDATION PLATE LEFT, GALVANIZED
4150122	FOUNDATION PLATE RIGHT, STAINLESS STEEL
4150123	FOUNDATION PLATE LEFT, STAINLESS STEEL



FOOT BRACKET FOR SLATS

30802	SINGLE FOOT BRACKET FOR SLATS
-------	-------------------------------



FOOT BRACKET FOR CONCRETE

30806	SINGLE FOOT BRACKET FOR CONCRETE
-------	----------------------------------



FOOT BRACKET FOR CONCRETE EQUIPMENT

30801	FOOT BRACKET FOR CONCRETE EQUIPMENT
-------	-------------------------------------



HALF FOOT PLATE, STAINLESS STEEL

8450701	HALF FOOT PLATE LEFT
8450702	HALF FOOT PLATE RIGHT



GATE HANDLE, STAINLESS STEEL

4910889	HANDLE LEFT
4910900	HANDLE RIGHT



LOWER GATE HINGER, STAINLESS STEEL

4950884	LOWER GATE HINGER RIGHT
4950887	LOWER GATE HINGER LEFT



HINGER FOR FRONT PARTITION

4900850	HINGER FOR FRONT PARTITION STAINLESS
---------	--------------------------------------



HINGER FOR HAT PROFILE

4900851	HINGER FOR HAT PROFILE STAINLESS
---------	----------------------------------



ANGLE BRACKET

550306	ANGLE BRACKET 36 X 36 X 65
--------	----------------------------



FLOOR ANGLE

4950955	FLOOR ANGLE 133 X 44 X 39 MM A2
---------	---------------------------------



FLEXCOVER® CLIMATE COVER

Two-climate cover made of 15 mm PVC board profiles

FLEXCOVER climate covers*	
Depth, cm	2 or 3 parts
85 straight	25/50
110 straight	50/50 25/75
116 straight	25/50/25
135 straight	50/75
160 straight	75/75
110 sloped	25/75
135 sloped	50/75

* max width is 300 cm.

If the width is more than 300 cm,
extra post is required.

- PVC with rounded profiles all over; no sharp edges
- Light, but at the same time durable construction with 15 mm plastic board profiles
- Tight fittings ensure top hygiene and easy cleaning
- Developed for modern pig production with many washings
- Hinge rails with flexible rubber hinge ensure draft-free environment
- Many build-in options with 25, 50 and 75 cm board profiles in combination with flexible hinge rails

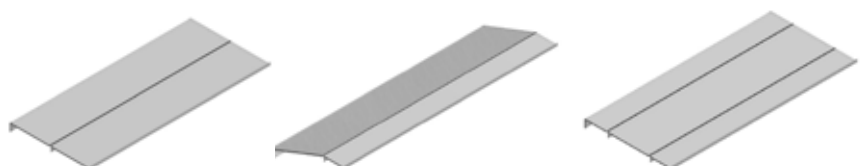

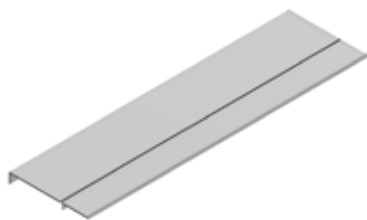

FLEXCOVER 85 CM 25/50

31488	2-PARTS 25/50 DEPTH 85 CM 3000 MM
31488-2	2-PARTS 25/50 DEPTH 85 CM 0-2500 MM

ACCESSORIES FOR 85 CM 25/50

31378	HAT PROFILE FOR 85 CM FLEXCOVER
31391	V-RAIL FOR 85 CM FLEXCOVER ON WALL
31392	V-RAIL FOR 85 CM FLEXCOVER ON BOARD PROFILE

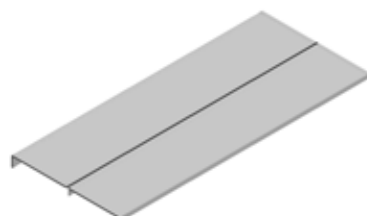

FLEXCOVER 110 CM 50/50

31492	2-PARTS 50/50 DEPTH 110 CM 3000 MM
31492-2	2-PARTS 50/50 DEPTH 110 CM 0-2500 MM

ACCESSORIES FOR 110 CM 50/50

31375	HAT PROFILE FOR 110 CM FLEXCOVER
31385	V-RAIL FOR 110 CM FLEXCOVER ON WALL
31386	V-RAIL FOR 110 CM FLEXCOVER ON BOARD PROFILE

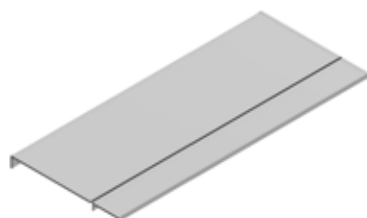

FLEXCOVER 110 CM 25/75

31485	2-PARTS 25/75 DEPTH 110 CM 3000 MM
31485-2	2-PARTS 25/75 DEPTH 110 CM 0-2500 MM

ACCESSORIES FOR 110 CM 25/75

31375	HAT PROFILE FOR 110 CM FLEXCOVER
31385	V-RAIL FOR 110 CM FLEXCOVER ON WALL
31386	V-RAIL FOR 110 CM FLEXCOVER ON BOARD PROFILE

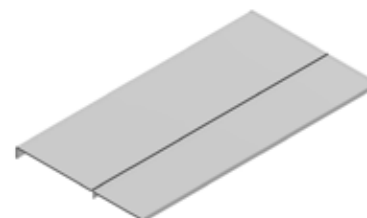

FLEXCOVER 135 CM 50/75

31486	2-PARTS 50/75 DEPTH 135 CM 3000 MM
31486-2	2-PARTS 50/75 DEPTH 135 CM 0-2500 MM

ACCESSORIES FOR 135 CM 50/75

31376	HAT PROFILE FOR 135 CM FLEXCOVER
31387	V-RAIL FOR 135 CM FLEXCOVER ON WALL
31388	V-RAIL FOR 135 CM FLEXCOVER ON BOARD PROFILE

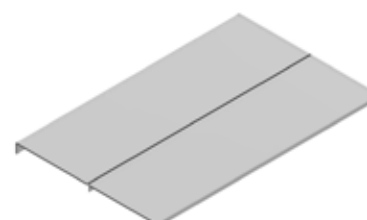

FLEXCOVER 160 CM 75/75

31487	2-PARTS 75/75 DEPTH 160 CM 3000 MM
31487-2	2-PARTS 75/75 DEPTH 160 CM 0-2500 MM

ACCESSORIES FOR 160 CM 75/75

31377	HAT PROFILE FOR 160 CM FLEXCOVER
31389	V-RAIL FOR 160 CM FLEXCOVER ON WALL
31390	V-RAIL FOR 160 CM FLEXCOVER ON BOARD PROFILE

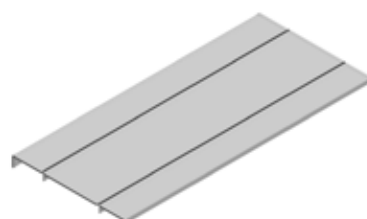

FLEXCOVER 116 CM 25/50/25

31493	3-PARTS 25/50/25 DEPTH 116 CM 3000 MM
31493-2	3-PARTS 25/50/25 DEPTH 116 CM 0-2500 MM

ACCESSORIES FOR 116 CM 25/50/25

31381	HAT PROFILE FOR 116 CM FLEXCOVER
31383	V-RAIL FOR 116 CM FLEXCOVER ON WALL
31384	V-RAIL FOR 116 CM FLEXCOVER ON BOARD PROFILE

FLEXCOVER 110 CM 25/75 SLOPED

31489	2-PARTS SLOPED 25/75 DEPTH 110 CM 3000 MM
31489-2	2-PARTS SLOPED 25/75 DEPTH 110 CM 0-2500 MM

ACCESSORIES FOR 110 CM 25/75 SLOPED

31393	V-RAIL F/110 CM SLOPED FLEXCOVER ON WALL
31394	V-RAIL F/110 CM SLOPED ON BOARD PROFILE, SINGLE
31395	V-RAIL F/110 CM SLOPED ON BOARD PROFILE, DOUBLE



FLEXCOVER 135 CM 50/75 SLOPED

31490	2-PARTS SLOPED 50/75 DEPTH 135 CM 3000 MM
31490-2	2-PARTS SLOPED 50/75 DEPTH 135 CM 0-2500 MM

ACCESSORIES FOR 135 CM 50/75 SLOPED

31396	V-RAIL F/135 CM SLOPED FLEXCOVER ON WALL
31397	V-RAIL F/135 CM SLOPED ON BOARD PROFILE, SINGLE
31398	V-RAIL F/135 CM SLOPED ON BOARD PROFILE, DOUBLE

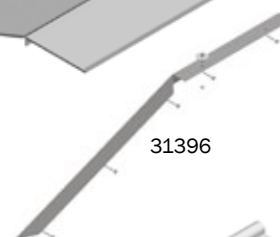
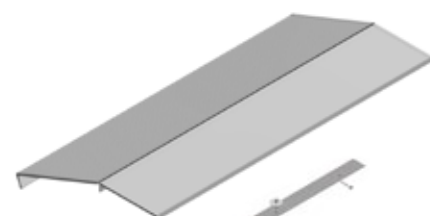

FLEXCOVER HAT PROFILE

30370	HAT PROFILE FOR FLEXCOVER (R.M.)
-------	----------------------------------



BRACE HAT PROFILE FOR FLEXCOVER

30372	BRACE HAT PROFILE FOR FLEXCOVER
-------	---------------------------------



SUPPORT HINGE RAIL FOR FLEXCOVER

30380	SUPPORT HINGE RAIL FOR FLEXCOVER
33908001	LOCK NUT M8 A2 DIN 985



OPENING SET FOR FLEXCOVER

92509	OPENING SET FOR FLEXCOVER, PER PEN
-------	------------------------------------



BOLT KIT FOR FLEXCOVER

39800	BOLT KIT FOR 1 FLEXCOVER AGAINST WALL
39801	BOLT KIT FOR 2 FLEXCOVER AGAINST BOARD PROFILE
39802	BOLT KIT FOR 1 FLEXCOVER AGAINST BOARD PROFILE



GLUE PEVICOL

23900112	GLUE PEVICOL 0,5 KG, FOR 25 CLIMATE COVERS
----------	--





STAINLESS STEEL TROUGHS

Made of strong stainless steel. Can be used for liquid feeding walls.

Material: 1 mm stainless steel
Length: 60-590 cm

Wean-To-Finish, finishers, young sows - double trough

Volume per meter 49 l
 Height 14,5 cm
 Width upper/lower 49,7 cm / 20 cm

Wean-To-Finish, finishers, young sows - single trough

Volume per meter 24,5 l
 Height 14,5 cm
 Width upper/lower 24 cm / 7 cm

Weaners - double trough

Volume per meter 38 l
 Height 12 cm
 Width upper/lower 43 cm / 20 cm

Weaners - single trough

Volume per meter 16 l
 Height 12 cm
 Width upper/lower 20 cm / 6 cm

Well designed and reliable

- Animal welfare and hygiene: completely smooth surface on the inside = minimum risk of injuries to the animal and accumulation of feed residue
- Suited for both dry and liquid feeding
- Minimum feed waste: inverted edges
- Easy cleaning: the troughs are mounted free on the floor allowing washing down underneath them

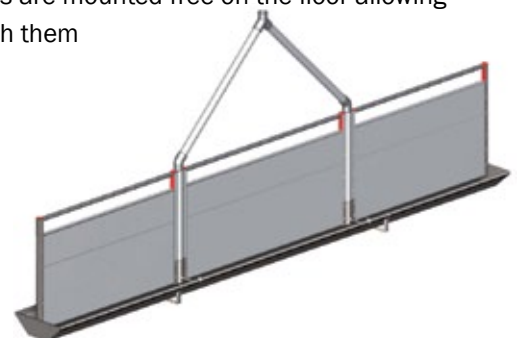

STAINLESS STEEL TROUGHS FOR BOXES WITH FRONT GATE

96181	STEEL TROUGH FOR PLASTIC JOINT
96182	STEEL TROUGH WITH WELDED GABLE

BRACKETS FOR STAINLESS STEEL TROUGHS - FOR 1 BOX

96203	BRACKET PLASTIC END PIECE FOR FRONT GATE
96204	BRACKET CONTINUOUS FOR FRONT GATE



STAINLESS STEEL TROUGHS FOR BOXES WITH FRONT PIPES

96180	STEEL TROUGH FOR PLASTIC JOINT
96183	STEEL TROUGH WITH WELDED GABLE

BRACKETS FOR STAINLESS STEEL TROUGHS - FOR 1 BOX

96201	BRACKET PLASTIC END PIECE FOR FRONT PIPES
96202	BRACKET CONTINUOUS FOR FRONT FOR FRONT PIPES

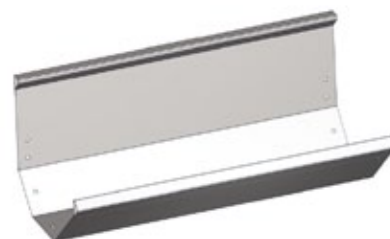

END PIECE FOR STEEL TROUGH

31025	END PIECE KIT IN PLASTIC FOR 1 STEEL TROUGH
-------	---



ASSEMBLY KIT FOR STEEL TROUGH

31030	ASSEMBLY KIT IN PLASTIC FOR 1 STEEL TROUGH
-------	--



STAINLESS STEEL TROUGHS FOR INN-O-WALL LIQUID FEEDING WALL - SINGLE

39218	LIQUID FEEDING TROUGH SINGLE FOR WEANERS
39211	LIQUID FEEDING TROUGH SINGLE FOR FINISHERS



STAINLESS STEEL TROUGHS FOR INN-O-WALL LIQUID FEEDING WALL - DOUBLE

39215	LIQUID FEEDING TROUGH DOUBLE FOR WEANERS
39234	LIQUID FEEDING TROUGH DOUBLE FOR FINISHERS

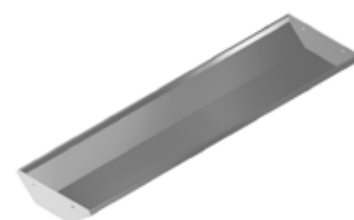

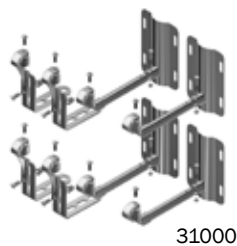

31000

FOOT BRACKETS FOR TROUGHS

31000	BRACKET SET FOR DOUBLE TROUGH, FINISHERS
31002	SUPPORT LEG FOR DOUBLE TROUGH, WEANERS



FOOT BRACKETS FOR TROUGHS

31001	BRACKET SET FOR SINGLE TROUGH, FINISHERS
31003	FOOT BRACKET FOR SINGLE TROUGH, WEANERS



ADAPTER FOR SUPPORT LEG

30053	ADAPTER FOR SUPPORT LEG 35 MM BOARD PROFILE
8530052	ADAPTER FOR SUPORT BRACKET FOR 50 MM WALL



WALL BRACKETS FOR SINGLE STEEL TROUGH

31050	WALL BRACKET FOR SINGLE TROUGH AGAINST WALL
-------	---



WALL BRACKETS FOR SINGLE STEEL TROUGH

31051	WALL BRACKET FOR SINGLE TROUGH, SINGLE AGAINST BOARD PROFILE
-------	--



WALL BRACKETS FOR SINGLE STEEL TROUGH

31052	WALL BRACKET FOR SINGLE TROUGH, DOUBLE AGAINST BOARD PROFILE
-------	--



LIQUID FEEDING WALL

39705	H:100 FOR 1+2 DOWNPIPE U-PROFILE/DOWNSPIPE
39706	MIDDLE PIECE H: 100 BOARD PROFILE/BARS
39718	F/1 DOWNPIPE H: 100 BOARD ROFILE/BARS W/O DOWNPIPE

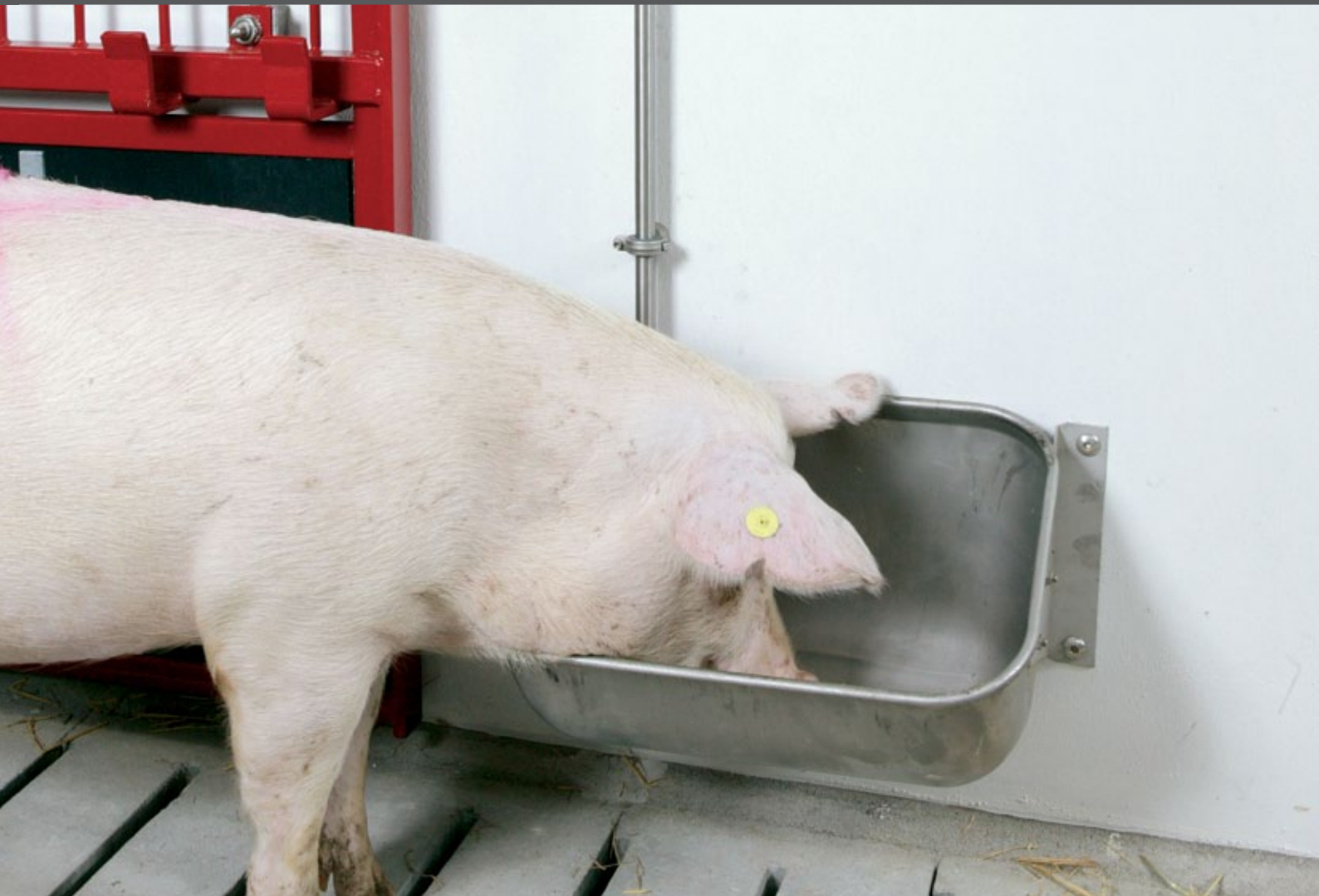

SOW TROUGH IN STAINLESS STEEL

For new and existing farrowing pens

Volume: 21 l
Material: 1 mm stainless steel
Holes: Ø9 mm, 2 in each side
Weight: 3,6 kg
Amount: 25 trough per 100 cm

- Durable and hygienic: heavy bend and closed edges, which can withstand even very heavy activation
- No weldings, which can cause leaks
- No blind corners, where feed remains and bacteria could accumulate
- No sharp edges which could cause injuries on sow and piglets

SOW TROUGH

42220	SOW TROUGH DEEP DRAWN	
42379	PLASTIC SIDES FOR SOW TROUGH, KIT	

BRACKET SET FOR SOW TROUGH

96054	BRACKET SET INCL. BOLT FOR WALL
96056	BRACKET SET INCL. BOLT FOR BOARD PROFILE
96058	BRACKET SET SINGLE MOUNTING ON BARS





POLYMER TROUGHS AND FEED TABLES

Your guarantee for optimal profit, animal welfare and working environment in pig production

Material:
Polymer concrete

Længde:
100 / 120 cm

- Smooth surface which prevents bacteria and manure bridging
- Easy to clean
- No sharp edges where manure can be collected
- No mouldings that can break after a short time
- Easy to mount
- Flexible and can be adjusted at the mounting place
- The most used trough principle in Europe for the past 30 years
- 4 times stronger than concrete



TS 25

02564	TS 25, 100 CM
02566	END GABLE FOR TS 25
02850	PARTITION FOR TS 25

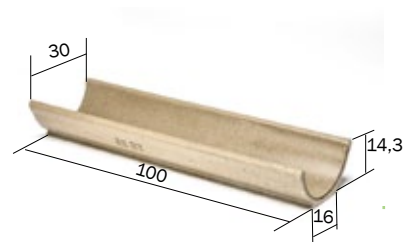

TS 28V

18444	TS 28 V, 100 CM
18445	PARTITION FOR TS 28 V

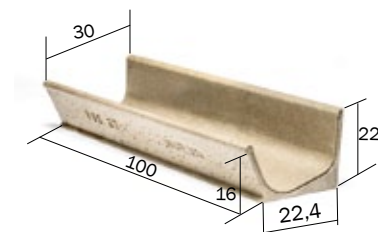

TS 30

01605	TS 30, 100 CM
17096	END TROUGH TS 30, 100 CM
17097	END TROUGH TS 30, 65 CM
01664	PARTITION FOR TS 30

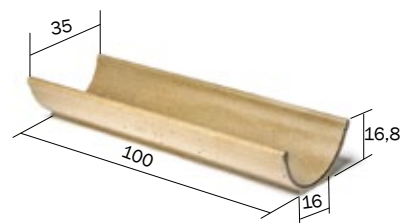

TS 35

01667	TS 35, 100 CM
17081	END TROUGH TS 35H, 50 CM, RIGHT
17080	END TROUGH TS 35V, 50 CM, LEFT
01670	PARTITION FOR TS 35

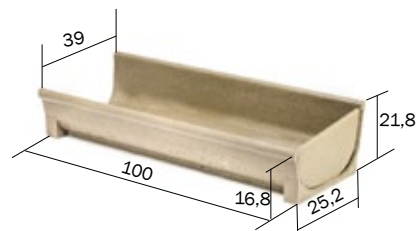

TS 36

02571	TS 36, 100 CM
17098	END TROUGH TS 36H, 50 CM, RIGHT
17099	END TROUGH TS 36V, 50 CM, LEFT
02605	PARTITION FOR TS 36

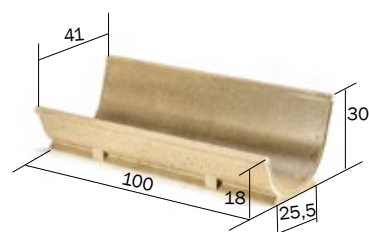

TS 41

03191	TS 41, 100 CM
01595	END TROUGH TS 41, 100 CM
01596	END TROUGH TS 41, 65 CM
03204	PARTITION FOR TS 41

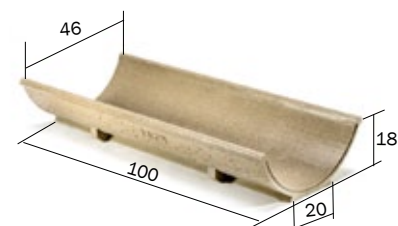

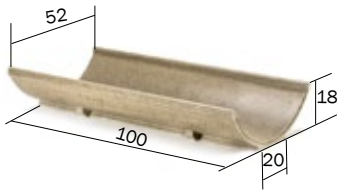

TS 47

01585	TS 47, 100 CM
03258	TS 47 WITH CLEANING OPENING, 100 CM
01586	END TROUGH TS 47, 100 CM
01587	END TROUGH TS 47, 65 CM

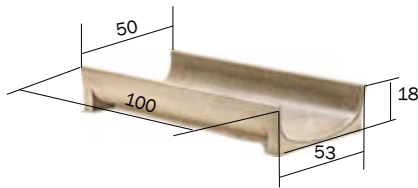

TS 50

02101	TS 50, 100 CM
01600	END TROUGH TS 50, 100 CM
01601	END TROUGH TS 50, 65 CM

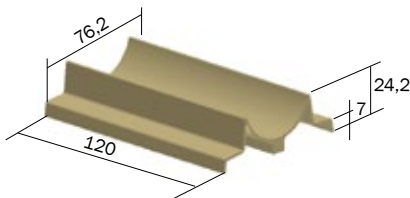

105-R

554201	TROUGH 105-R, 120 CM
554203	END TROUGH 105-R, 120 CM

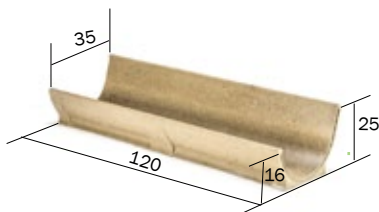

TROUGH 110

554157	TROUGH 110, 120 CM
554170	PARTITION FOR TROUGH 110

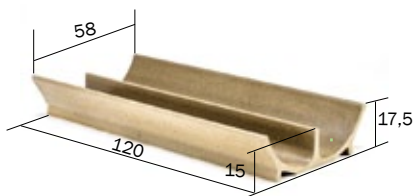

TROUGH 116

554128	TROUGH 116, 120 CM
554162	PARTITION FOR TROUGH 116

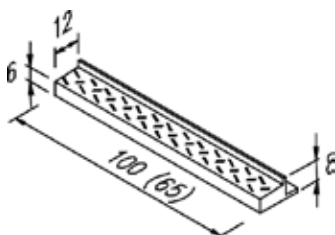

STEP

09518	STEP TS 100, 100 CM
09519	STEP TS 65, 65 CM

TS 35-50

09550	SINGLE TROUGH T35-50, FOR ENCASED IN CONCRETE
-------	---



T 35-60

09552	SINGLE TROUGH T35-60, FOR ENCASED IN CONCRETE
-------	---



T 36-49,5

18333	SINGLE TROUGH T39-49,5, WITH PLUG
-------	-----------------------------------



DT 14 R

17297	SINGLE TROUGH DT 14 R, WITH PLUG, RIGHT
-------	---

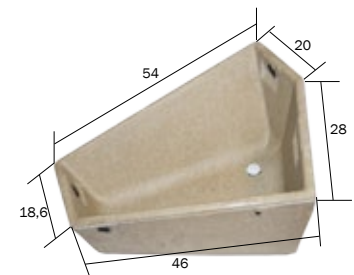

DT 14 L

17298	SINGLE TROUGH DT 14 L, WITH PLUG, LEFT
-------	--

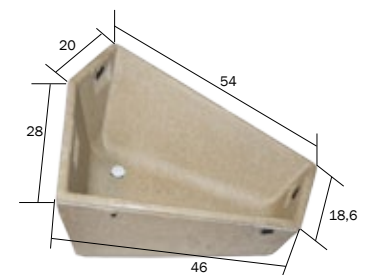

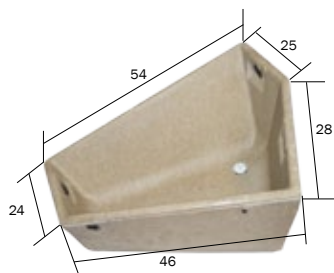

DT 20 R

17299	SINGLE TROUGH DT 20 R, WITH PLUG, RIGHT
-------	---

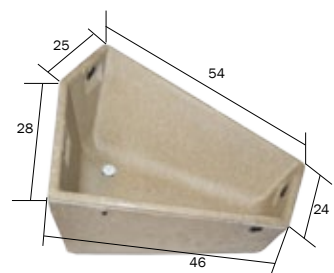

DT 20 L

17300	SINGLE TROUGH DT 20 R, WITH PLUG, LEFT
-------	--



POLYESTER GLUE

02163	0,5 KG, 150 G PER JOINT 250 G PER PARTITION
18435	4 KG, 150 G PER JOINT, 250 G PER PARTITION

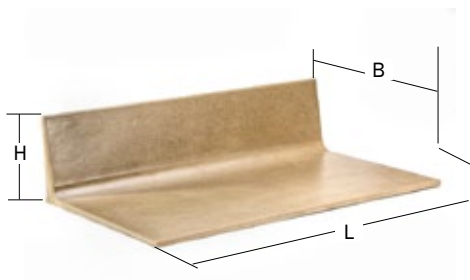

FEED TABLES FOR CATTLE

09655	FEED TABLE KL 60	L: 100 X H: 17 X B: 58 CM
17385	FEED TABLE KL 70S	L: 100 X H: 6 X B: 69 CM
02326	FEED TABLE KL 70	L: 100 X H: 17 X B: 70 CM
09693	FEED TABLE KL 72	L: 100 X H: 27 X B: 72 CM
09657	FEED TABLE KL 80	L: 100 X H: 22 X B: 80 CM
18268	FEED TABLE KL 100	L: 70 X H: 27 X B: 100 CM



MANURE PLUG

17334	MANURE PLUG DN 150, A: 205 X B: 150 MM
17016	MANURE PLUG DN 200, A: 232 X B: 181 MM
17161	MANURE PLUG DN 250, A: 284 X B: 233 MM
17162	MANURE PLUG DN 300, A: 339 X B: 284 MM

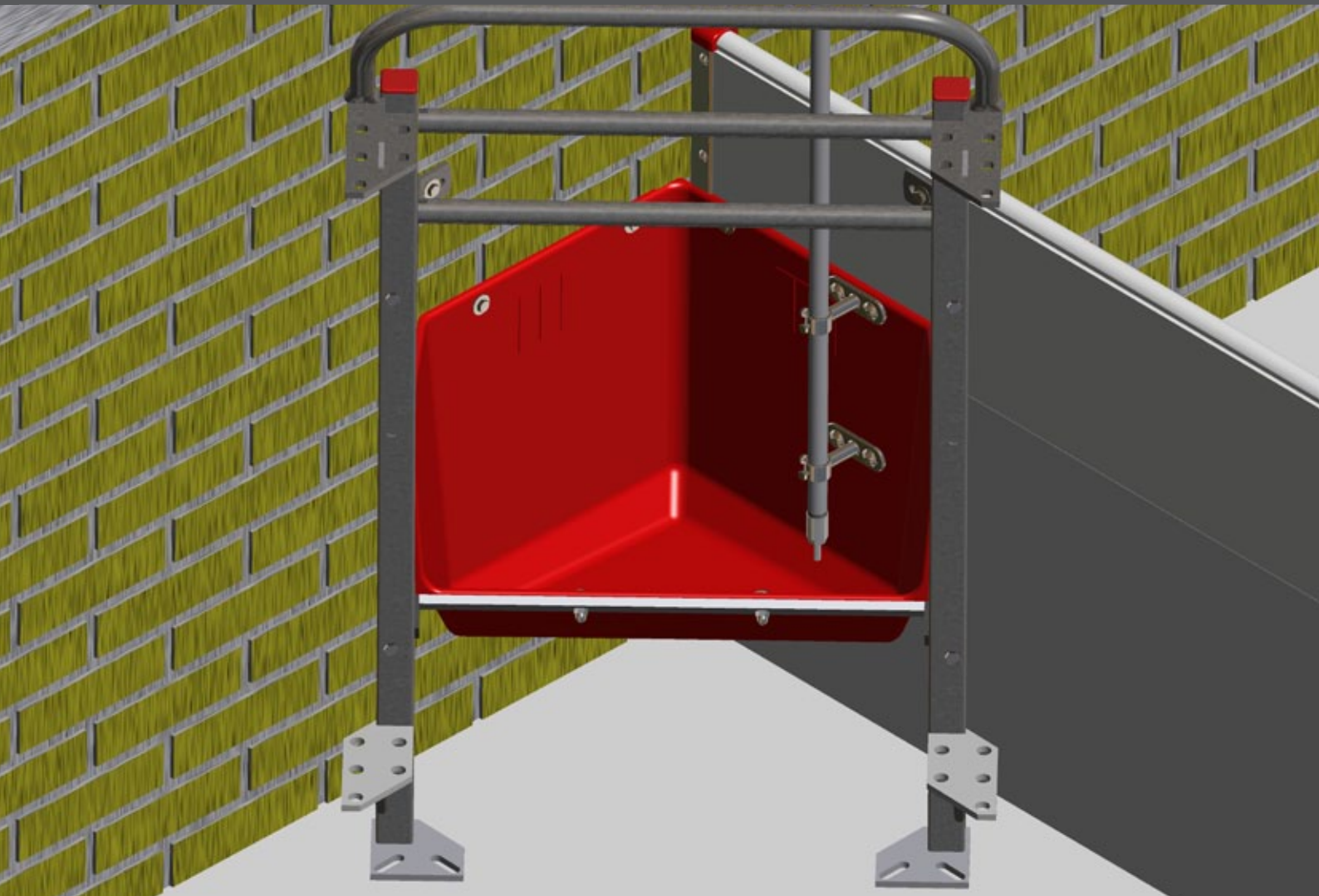

BIOLINE CORNER

Corner trough for sows in loose farrowing pens

Volume: 19,5 liter
Material: PP



AGROMEK
STAR 2016

- Strong trough for sows
- Made of acid-proof materials
- Volume is 19,5 l
- Minimum feed waste
- Fits to U-profile in the corner
- Tight fit to the wall / pen equipment

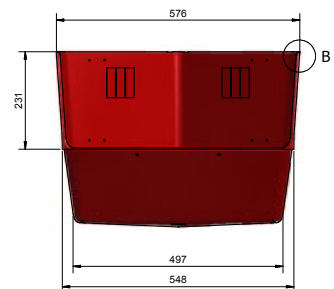

BIOLINE CORNER

2960565	PLASTIC CORNER TROUGH FOR SOWS
---------	--------------------------------





DRY FEEDING SYSTEM

Easy inspection, uniform feed supply and high reliability

MASTER CHAIN®

Tube	Pull	Capacity
38 mm	Chain / wire	400 kg/hour
50 mm	Chain / wire	700 kg/hour
60 mm	Chain	1000 kg/hour

Max length with up to 12 corners is 300 m.
Thereafter it is possible to add 10 m of chain for every deducted corner.

COMPAC 4

Tube	Pull	Capacity
60 mm	Chain	1000 kg/hour

Max length with 8 corners is 450 m.

Stabil og ensartet foderforsyning med mangeårig driftssikkerhed:

- Easy maintenance: the front part is made of transparent plastic, standard motor with few wear parts
- Long durability: V-belt drive = elastic, even pull with minimum wear
- High security: emergency stop
- Low energy consumption: powerful transmission with high efficiency and low ration, which at the same time prevents super heating
- Adjustable feed pull out - prevents bridging
- Optimal utility: adjustable dispensing, for both flour and pellets



DRIVE UNITS WITH CHAIN - MASTER CHAIN®

85006	38 MM CHAIN WITH LOOSE DRIVE WHEEL
84956	50 MM CHAIN WITH LOOSE DRIVE WHEEL
84900	60 MM CHAIN
84880	76 MM CHAIN



DRIVE UNITS WITH WIRE - MASTER CHAIN®

85005	38 MM WIRE WITH LOOSE DRIVE WHEEL
84955	50 MM WIRE WITH LOOSE DRIVE WHEEL

DRIVE UNITS COMPAC 4

0211-424	COMPAC 4, V TOWARD H, 1,5 KW
0211-425	COMPAC 4, V TOWARD H, EXCL. MOTOR
0211-426	COMPAC 4, H TOWARD V, 1,5 KW
0211-427	COMPAC 4, H TOWARD V, EXCL. MOTOR



ACCESSORIES FOR MASTER CHAIN® DRIVE UNIT

85064	ANGULAR BRACKET CROSSWISE, INCL. BOLTS
85060	ANGULAR BRACKET, INCL. BOLTS
85057	FOOT FOR DRIVE UNIT, COMPLETE



RECEPTION UNITS

0212-510	RECEPTION UNIT 38 MM GALVANIZED
0212-520	RECEPTION UNIT 50 MM GALVANIZED
0212-530	RECEPTION UNIT 60 MM GALVANIZED
0212-540	RECEPTION UNIT 76 MM GALVANIZED
0212-610	RECEPTION UNIT 38 MM STAINLESS
0212-620	RECEPTION UNIT 50 MM STAINLESS
0212-630	RECEPTION UNIT 60 MM STAINLESS
0212-640	RECEPTION UNIT 76 MM STAINLESS



FUNNELS

0112-014	FUNNEL U-60
0112-019	FUNNEL U-150
0112-196	COVER FOR 60 L FUNNEL
0112-015	FUNNEL U-20
0112-202	STRAP FOR SQUARE FUNNEL



CORNERS

86205	CORNER FOR 38 MM SYSTEM
86193	CORNER FOR 50 MM SYSTEM
86187	CORNER FOR 60 MM SYSTEM
86186	CORNER FOR 76 MM SYSTEM



CORNERS

0115-000	CORNER Ø38/FS - 90°
0213-123	CORNER Ø60 MM - 90°
0213-200	CORNER Ø60 MM - 90°, STAINLESS





0142-044

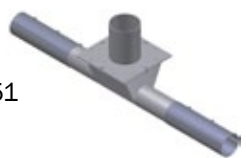

0142-151



0170-521



CONNECTION SYSTEM

CROSS DRAIN

0142-044	CROSS DRAIN Ø38 MM, COMPLETE
0142-046	CROSS DRAIN Ø60 MM, COMPLETE
0170-517	CROSS DRAIN Ø76 MM, COMPLETE

CROSS DRAIN AND CONNECTOR

0142-151	CROSS DRAIN Ø38 AND CONNECTOR Ø80
0142-152	CROSS DRAIN Ø60 AND CONNECTOR Ø80
0170-518	CROSS DRAIN Ø76 AND CONNECTOR Ø80
0170-522	CROSS DRAIN Ø50 AND CONNECTOR Ø80

CONNECTION SYSTEM

0170-521	CONNECTION UNIT PIPE-PIPE 50 MM, COMPLETE
----------	---

CONVEYER TUBES

0116-003	Ø38 MM WITH JOINT, L: 5 M, PRICE PER METER
86114	Ø50 MM WITH JOINT, L: 5 M, PRICE PER METER
0214-105	Ø60 MM WITH JOINT, L: 5 M, PRICE PER METER
86135	Ø76 MM WITHOUT JOINT, L: 6 M, PRICE PER METER

CONNECTION JOINT

86125	FOR 38 MM FEED TUBE, COMPLETE
86115	FOR 50 MM FEED TUBE, COMPLETE
86100	FOR 60 MM FEED TUBE, COMPLETE
86137	FOR 76 MM FEED TUBE, COMPLETE

CONICAL DRILL

86148	CONICAL DRILL FOR FEED TUBE Ø16-30,5
-------	--------------------------------------

MASTER CHAIN® CHAIN “ANTITWIST”

86086	CHAIN FOR 38 MM FEED TUBE
86084	CHAIN FOR 50 MM FEED TUBE
86085	CHAIN FOR 60 MM FEED TUBE
86087	CHAIN FOR 76 MM FEED TUBE

POWERLINE CHAIN AND CONVEYER CABLE

0117-200	POWERLINE CHAIN Ø38 MM
0117-225	POWERLINE CHAIN Ø60 MM
0117-004	CONVEYER CABLE Ø38 WIRE
0214-104	CONVEYER CABLE Ø60-M
0215-117	JOINT LINK FOR CONVEYER CABLE Ø60

JOINT LINK FOR MASTER CHAIN® OG POWERLINE® CHAIN

86029	JOINT LINK FOR MASTER CHAIN® CHAIN
0117-205	JOINT LINK FOR POWERLINE® CHAIN

SWIVEL

86033	SWIVEL FOR MASTER CHAIN® CHAIN
39408080	SWIVEL FOR POWERLINE® CHAIN



WIRE

0117-004	WIRE FOR Ø38 SYSTEM, PR. METER
85982	WIRE FOR 50 MM SYSTEM, PER METER
86035	WIRE CONNECTOR WITH SCREW
86030	WIRE CUTTER
0117-126	ASSEMBLING SET FOR CABLE, COMPLETE



ELECTRONIC CONTROL UNIT MASTER CHAIN®

88408	CONTROL UNIT FOR 1 SYSTEM
88403	CONTROL UNIT FOR 2 SYSTEMS
88412	CONTROL UNIT FOR OPENING OF FEED DISPENSERS
88445	FOIL DISPLAY



ELECTRONIC CONTROL FUNKIFEED®

0153-451	FUNKIFEED VER. 3
0153-403	FUNKIFEED STOP SENSOR FOR Ø38 SYSTEM, COMPLETE
0153-404	FUNKIFEED STOP SENSOR FOR Ø60 SYSTEM, COMPLETE



ELECTRONIC SWITCH SENSOR

88865	SWITCH SENSOR 38 MM SERIE 6000
88860	SWITCH SENSOR 50 MM SERIE 6000
88855	SWITCH SENSOR 60 MM SERIE 6000
0170-850	SWITCH SENSOR 76 MM



PIPE HANGER

0146-340	PIPE HANGER 20X26 CM
0146-334	PIPE HANGER 26X45 CM
0146-335	PIPE HANGER 47X61 CM
0146-339	PIPE HANGER 27X37 CM



TUBE SUPPORT

0146-305	TUBE SUPPORT C-SHAPED 1,25 M
0146-291	TUBE SUPPORT C-SHAPED 2 M



FITTINGS

0146-300	CLAMP RING FOR TUBE SUPPORT, COMPLETE
0146-317	PIPE FITTING Ø60
0146-301	FORK (35-40 MM) FOR TUBE SUPPORT, COMPLETE
0146-333	FORK (50 MM) FOR PANELS 50 MM, COMPLETE



0146-300 0146-301 0146-333

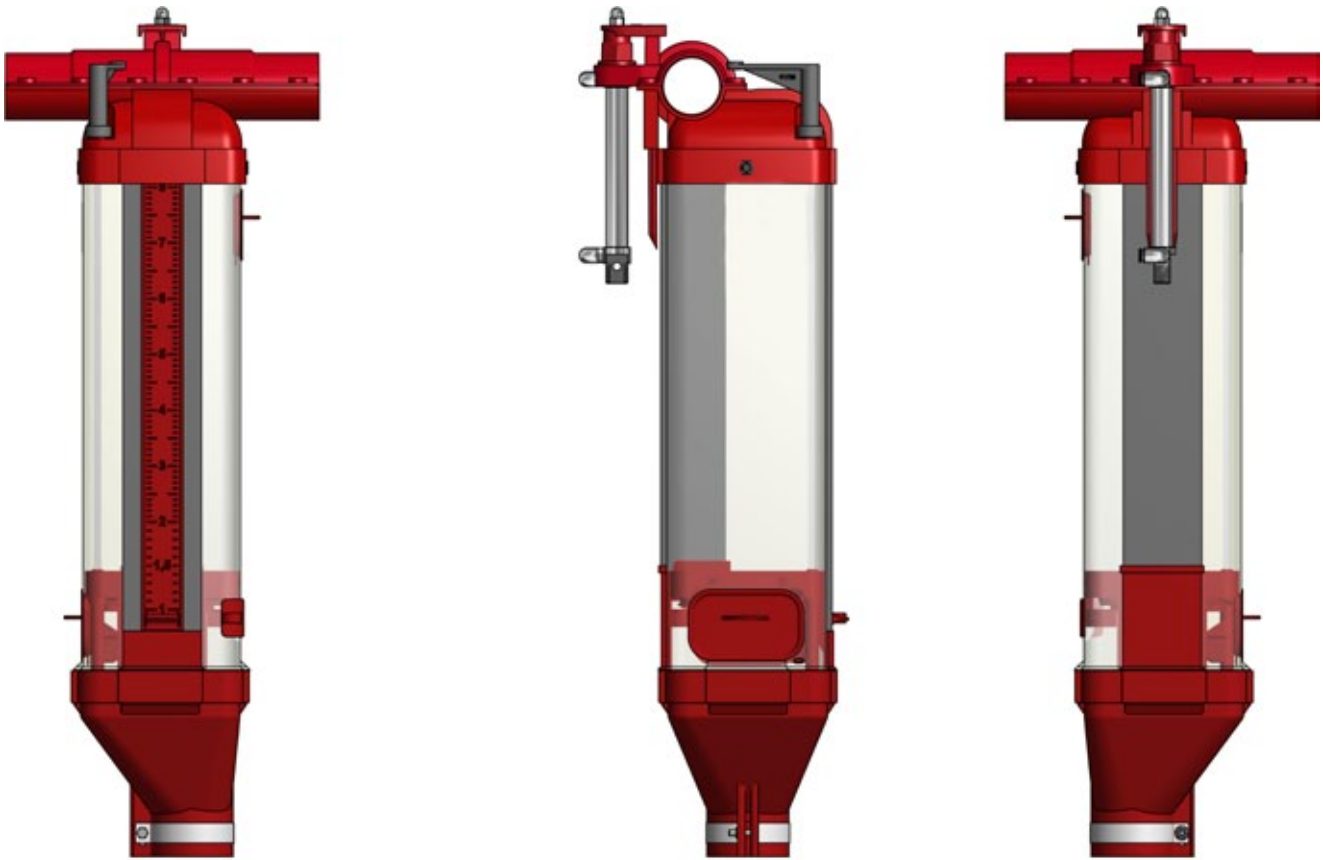

MASTER VALVE SOW

Feed dispenser with integrated feed valve - perfect for phase feeding of sows

FEED DISPENSER:

VD6 81



AGROMEK STARS 2016

- Perfect for phase feeding of sows in the farrowing and gestation units
- Save feed costs
- Optimal use of feeding system
- User-friendly control unit
- Simple and reliable
- Lock for feed release, if the sow has not eaten up
- Easy to adjust feed amount
- Can be adjusted with feed in feed dispenser





MASTER VALVE DRY

Pneumatic valve for dry feed with Y-outlet

FACTS

Ø60 valve / Ø75 outlet



AGROMEK
STAR 2016

- Special Y-outlet for simultaneous use with several dry feed units
- Operates with a pneumatic cylinder with air pressure
- Individually controlled feeding
- Ø60 valve / Ø75 outlet
- Easy lock
- Easy cleaning of pipes





FEED DISPENSERS AND FEED OUTLETS

Reliable feed distribution and precise dosage

Volume: 6 / 8 / 10 l

Fits to feed tubes:

VD2 $\varnothing 38 / \varnothing 60$ mm
VD5 $\varnothing 38 / \varnothing 50 / \varnothing 55 / \varnothing 60 / \varnothing 70$ mm
VD6 $\varnothing 75$ mm

- Reliable feed distribution even by small amounts: strong bottom, the feed does not sift out inadvertently. At the same time the dispenser is emptied at every feeding - no feed remains in the hopper.
- Exact dosage: no feed dosing pipe in the feed dispenser. The scale shows exact amount being fed.
- Easy adjustment: the amount of feed is easily adjusted by using the handle on the side of the feed dispenser. The handle can be operated from the feed corridor.
- Extra durable: minimum wear because of the simple construction.



VD6 FEED DISPENSER 8 L, FOR 60 MM SYSTEM

0222-660	VD6-Ø60, 8 L WITH FLAP, WITH Ø75 OUTLET
----------	---



VD2 FEED DISPENSERS WITH Ø75 MM OUTLET, COMPLETE

0221-252	VD2-Ø60, 6 L WITH FLAP, Ø75 MM OUTLET
0221-253	VD2-Ø60, 8 L WITH FLAP, Ø75 MM OUTLET
0221-254	VD2-Ø60, 10 L WITH FLAP, Ø75 MM OUTLET



VD5 FEED DISPENSERS WITH Ø75 MM OUTLET, COMPLETE

0221-950	VD5-Ø75, 10 L WITH BALL, Ø75 MM OUTLET
0221-951	VD5-Ø60, 10 L WITH BALL, Ø75 MM OUTLET
0221-952	VD5-Ø50, 10 L WITH BALL, Ø75 MM OUTLET
0221-953	VD5-Ø38, 10 L WITH BALL, Ø75 MM OUTLET
0221-954	VD5-Ø55, 10 L WITH BALL, Ø75 MM OUTLET



VD5 FEED DISPENSERS WITH Ø75 MM OUTLET WITH CENTRAL FUNNEL

0221-960	VD5-Ø75, 10 L WITH Ø75 MM OUTLET
0221-961	VD5-Ø60, 10 L WITH Ø75 MM OUTLET
0221-962	VD5-Ø50, 10 L WITH Ø75 MM OUTLET
0221-963	VD5-Ø38, 10 L WITH Ø75 MM OUTLET
0221-964	VD5-Ø55, 10 L WITH Ø75 MM OUTLET



VD5 REDUCING INLET

0221-927	VD5 REDUCING INLET ¹
0221-921	BOTTOM FOR VOLUME DISPENSER VD5



VD5 REDUCING INLET

0221-939	VD5 REDUCING INLET ²
----------	---------------------------------



¹ Reduce the feed by 0,45 l.

² Reduce the feed by 0,45 l.



VD100 FLOOR FEEDER

0223-240	FLOOR FEEDER VD100, UNMOUNTED
----------	-------------------------------



“MASTER VALVE DRY” DRY FEEDING VALVE

0228-550	DRY FEEDING VALVE, COMPLETE
----------	-----------------------------



“MASTER VALVE SOW”

0222-655	FEED DISPENSER WITH INTEGRATED FEED VALVE
0222-650	AIRTOP FOR VD6 - INTEGRATED FEED VALVE



HOPPER

91810	HOPPER FOR 76 MM FEED TUBE, COMPLETE
-------	--------------------------------------



CONNECTIONS FOR VD2 FEED DISPENSERS

0131-191	CONNECTION FOR VD2 Ø60/Ø38
0221-400	CONNECTION FOR VD2 Ø60/Ø50
0221-401	CONNECTION FOR VD2 Ø60/Ø55

FEED OUTLET Ø76 MM, GALVANIZED¹

0170-984	FEED OUTLET Ø76 MM L: 119,5 CM
0170-998	FEED OUTLET Ø76 MM L: 131,0 CM



OUTLET²

90249	FEED OUTLET PLASTIC 75 MM. LENGTH 100 CM
40320	PROTECTION PIPE FOR OUTLET, STAINLESS



BRANCH OUTLET

90210	Y-BRANCH ABS 75 MM 90°
90211	Y-BRANCH ABS 63 MM 60°
90212	Y-BRANCH ABS 63 MM 30°



BEND

90208	BEND 45° ABS 75 MM
-------	--------------------



DOWNPIPE

0228-588	DOWNPIPE Ø63X2, 1000 MM WITH HOLE
0228-589	DOWNPIPE Ø63X2, 3000 MM WITH HOLE
0228-590	DOWNPIPE Ø67,5X2, 985 MM



PIPE GALVANIZED

0221-022	PIPE Ø80X1,5X120 MM
0221-198	PIPE Ø80X1,5X710 MM
0221-199	PIPE Ø80X1,5X980 MM



CLAMP COMPLETE

0221-196	CLAMP 1" X Ø80 MM, COMPLETE
0221-214	CLAMP 1" X Ø96 MM, COMPLETE, ELECTRO-GALVANIZED
0221-315	CLAMP 3/4" X Ø80 MM, COMPLETE
0221-172	CLAMP 5/4" X Ø80 MM, COMPLETE



AUTOMATIC OPENING SYSTEM

88600	OPENING MOTOR INCL. BRACKETS
-------	------------------------------



MANUAL OPENING SYSTEM FOR FEED DISPENSERS

92400	MANUAL OPENING - MOUNTED ON WALL
92403	MANUAL OPENING - MOUNTED ON FEED TUBE



¹ For 8 l plastic feed dispensers, mounting on boxes and pens.

² For plastic feed dispensers, mounting on farrowing pens.

**WALL BRACKET**

92580	WALL BRACKET FOR STAY TIGHTENER
-------	---------------------------------

**PIANO WIRE**

02900021	PIANO WIRE 2,1 MM, STAINLESS
----------	------------------------------

**SPRING FOR MANUAL OPENING OF FEED DISPENSERS**

92375	35 KG/42 DISPENSERS AND 63KG/80 DISPENSERS
-------	--

**WIRE**

92540	WIRE 3 MM
92536	WIRE 4 MM 7 X 19
91491	WIRE 5 MM, STAINLESS



0591-174



0221-935

WIRE LOCK

0591-174	WIRE LOCK 5 MM, STAINLESS
0221-935	WIRE LOCK FOR VD5, PLASTIC

**TURN BUCKLE**

0591-171	TURN BUCKLE 8 MM, STAINLESS
----------	-----------------------------

**BRACKET FOR MOUNTING OF FEED TUBE**

92021	BRACKET FOR NEW FEED DISPENSER, 1 SPRING
-------	--

**BRACKET FOR MOUNTING OF FEED TUBE**

92022	BRACKET FOR 60 MM WIRE ROLLER
-------	-------------------------------

**BRACKET**

92386	BRACKET FOR DISPLACEMENT OF WIRE 60 MM
-------	--

WIRE ROLLER BRACKET

92573	WIRE ROLLER BRACKET WITH HOOK AND ANGLE BRACKET
-------	---

WIRE ROLLER BRACKET

92581	WIRE ROLLER BRACKET FOR WALL
-------	------------------------------

WIRE ROLLER BRACKET

92588	WIRE ROLLER BRACKET FOR ALL PARALLEL
-------	--------------------------------------

WIRE ROLLER BRACKET

92595	WIRE ROLLER BRACKET FOR WALL, PROTRUDING, COMPLETE
-------	--

PULLEY WHEEL

0156-004	PULLEY WHEEL TYPE G
----------	---------------------

PULLEY WHEEL AND BRACKET

0156-005	PULLEY WHEEL AND BRACKET G+L, LEFT
----------	------------------------------------

0156-006	PULLEY WHEEL AND BRACKET G+R, RIGHT
----------	-------------------------------------

PULLEY WHEEL AND BRACKET

0156-008	PULLEY WHEEL AND BRACKET G+T
----------	------------------------------

HAND WINCH

0152-017	HAND WINCH, COMPLETE 500 KG
----------	-----------------------------

EYE HOOK

0221-366	EYE HOOK
----------	----------

0591-174	WIRE LOCK 5 MM, STAINLESS
----------	---------------------------

09000017	STEEL WIRE Ø3-7X19 AISI 316
----------	-----------------------------

0221-935	WIRE LOCK PVC FOR VD5
----------	-----------------------





T-ANCHOR

30871	T-ANCHOR HEIGHT 80-100 MM
30875	T-ANCHOR HEIGHT 100-120 MM
30872	BOLT FOR T-ANCHOR 10X90 BH TORX 50

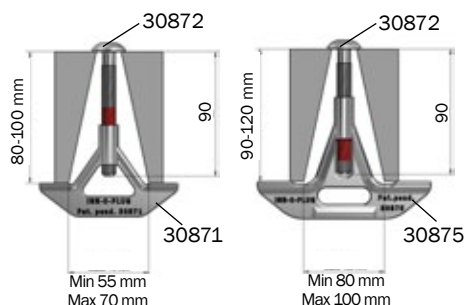

SLAT ANCHOR

17128	SLAT ANCHOR M8 GREEN
17731	SLAT ANCHOR M10 GREEN



RETAINING TOOL FOR T-ANCHOR

30878	RETAINING TOOL FOR MOUNTING OF T-ANCHOR
17105	TOOL FOR BOLT-ON FITTING 1900241



CONNECTING SCREW SET, STAINLESS

4900466	CONNECTING SCREW SET 39-48 MM
4900467	CONNECTING SCREW SET 44-58 MM
4900468	CONNECTING SCREW SET 49-68 MM

BRACKETS FOR CAST IRON SLATS

96965	MOUNTING BRACKET 40 X 30 MM
1920241	BOLT-ON FITTING 90 X 40 MM
96967	BRACKET FOR CAST IRON SLATS, SET 10 PCS.
1900241	BOLT-ON FITTING FOR CAST IRON SLATS, SET 10 PCS.
30308071	BUTTONHEAD SCREW M8X70 TX 50 W/O WASHER, STAINLESS



ANCHOR FOR PLASTIC SLATS

30847	ANCHOR M8 FOR PLASTIC SLATS
90130847	ANCHOR M8 FOR PLASTIC SLATS, LARGE
30889	BOLT M8 X 65 TORX 50
30888	BOLT M8 X 90 TORX 50
30887	BOLT M8 X 120 TORX 50



COACH SCREW

67442	COACH SCREW 10 X 100 TORX 50, STAINLESS
67444	COACH SCREW 10 X 70 TORX 50, STAINLESS



RHOMB SCREW ANCHOR

18958	RHOMB SCREW-ANCHOR FOR PIGLET SLATS (BAG 10 PCS.)
-------	---



CONCRETE SCREW

39406050	CONCRETE SCREW 6,5 X 50
67451	CONCRETE SCREW 10 X 70 TORX 50



